

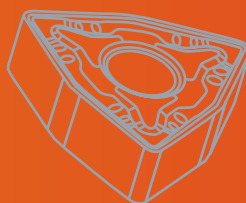

K·CERA

Cutting Tools 2019-2020



TIGER

info@hartman-n.ru

터닝 / TURNING

그루빙 / GROOVING

나사 / THREADING

밀링 / MILLING

인덱서블 드릴/ DRILLING

엔드밀 / ENDMILLS

솔리드 드릴/ DRILLS

부품 / SPARE PARTS

색인표 / INDEX

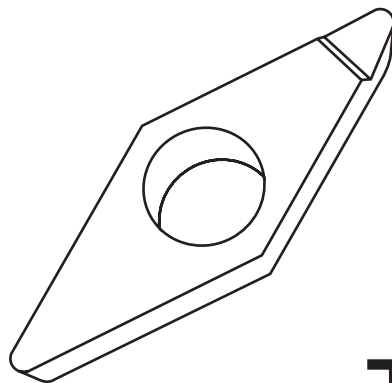
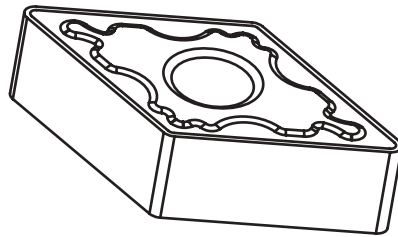
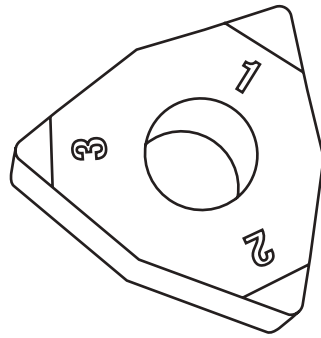

TURNING/ 터닝

인서트 carbide /5

PCBN /75

PCD diamond /95

터닝 홀더 holders /111

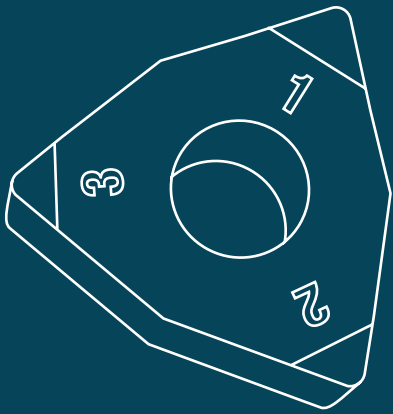

TURNING / carbide
터닝 / 인서트

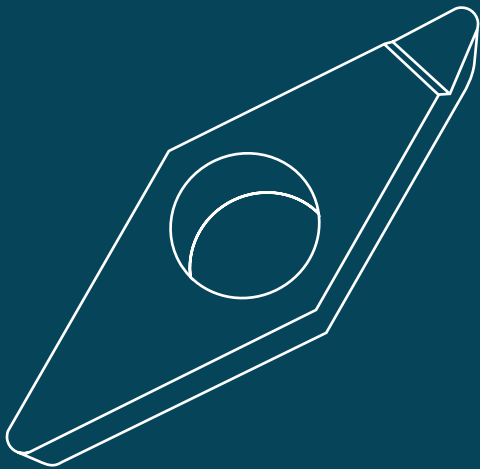
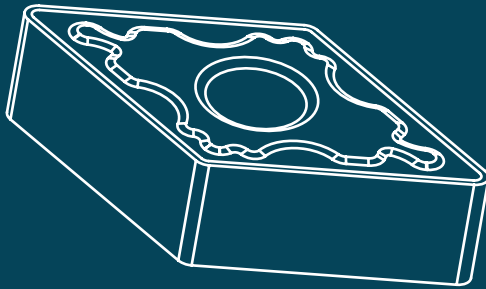

터닝

그루브

나사

임핀

인테셔널 드릴







엔드밀



슬리드 드릴



부분



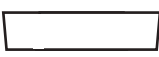

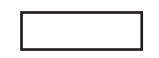
색인표







C	N	M	G	12	04	08
1	2	3	4	5	6	7

1	Geometry/ 인서트 형상
C	
D	
K	
S	
T	
V	
W	

2	Clearance Angle 주절인 여유각
B	 5°
C	 7°
P	 11°
N	 0°

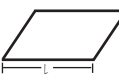
3	Tolerance/ 공차	
		
G	±0.025	±0.13
M	±0.05 ±0.15	±0.13
U	±0.08 ±0.25	±0.13

4	Shape/ 단면형상
A	
G	
M	
T	
X	Special

5	Shape/ 인선길이
C	06 09 12 16 19 25 
D	07 11 15 
K	16 
S	09 12 15 19 25 
T	09 11 16 22 
V	11 16 22 
W	06 08 

6	Thickness 인선높이(메트릭)
02	2.38
03	3.18
T3	3.97
04	4.76
06	6.35
09	9.52

7	Corner Radius 노즈(nose) "r" 크기(메트릭)
02	0.20
04	0.40
08	0.80
12	1.20
16	1.60
24	2.40

TURNING 터닝

U	M
8	9

T	C	5	2	20	P
Cera Tiger	10	11	12	13	14

8	C/B Series C/B 종류	9	C/B Type 칩브레이커
U	Finish / 정사상	UF,UF1	Negative type 네가티브 타입
	Medium / 중삭	UM,UM1,UMC,MM	
	Rough / 황삭	UR,UR1,RB25,RH25	
	Finish / 정사상	UF,MF1	Positive type 포지티브 타입
	Medium / 중삭	UM,UM2,MM1,TQ	
	Rough / 황삭	UR,UR2	
M	Finish / 정사상	MF,MF2,MF3	Negative type 네가티브 타입
	Medium / 중삭	MM,MM2,MM3,MM4,UM1	
	Rough / 황삭	MR,MS,UR1	
	Finish / 정사상	MF,MF1,MF2	Positive type 포지티브 타입
	Medium / 중삭	GM, MM1,MM3,MM5,TQ	
	Rough / 황삭	UR2	
K	Medium / 중삭	MM1,UM1	Negative type 네가티브 타입
	Rough / 황삭	Non(Box type), UR1	
A	Universal / 범용	AU	Normal 일반
		AUP	Premium 프리미엄

10	Coating & Material 코팅 & 소재
C	CVD Coated Carbide / CVD 코팅 인서트
P	PVD Coated Carbide / PVD 코팅 인서트
T	Cermet / 써멧
U	Uncoated Carbide / 초경

11	Workpiece Material 피삭재별 구분
4	Cast Iron 주철
5	Steel 강
6	Stainless Steel 스테인레스 스틸
0	Universal 범용

12	Machining 가공영역별 구분
1,2	Turning 터닝
0	Universal 범용
5	Grooving 그루빙
	Drilling 드릴링

13	ISO Grade ISO 정도
05	
10	
15	
20	
25	
30	
35	
40	
45	











14	Grade 프리미엄 재종
P	Premium 프리미엄
non	Normal 일반

TURNING
GROOVING
THREADING
MILLING
DRILLING
ENDMILLS
DRILLS
SPARE PARTS
INDEX

Grades / 재종

ISO DIN 513	K					P					M					N			
	K01	K10	K20	K30	K40	P01	P10	P20	P30	P40	M01	M10	M20	M30	M40	N01	N10	N20	N30
CARBIDE CVD	TC4105					TC5110					TC6115								
	TC4115D					TC5210					TC6125								
	TC4215					TC5120													
	TC4315					TC5220													
CARBIDE PVD						TC5230													
						TP0005HP					TP0005P								
											TP0005HP								
											TP0105P								
											TP0010P								
											TP0015P								
CARBIDE UNCOATED											TP0115P								
											TP0025					TU4005			
CERMET	TT5115					TT5115					TT5115								
	TTP5115					TTP5115					TTP5115								

CVD Turning Grades / 터닝 재종

Material 피삭재	Grade 재종	ISO 범위	Color 색깔	Operation 적용
P	TC5110	P10~P20	YELLOW 	● CVD코팅(Coated) - MT-TiCN + α-Al2O3 + TiN
	TC5210	P10~P20	YELLOW - BLACK 	● CVD코팅(Coated) - MT-TiCN + α-Al2O3 + TiN + post blasting treatment ● 내마모성과 인성이 우수한 전용모재와 내열성, 내소성변형이 우수한 알파알루미나(α-Al2O3)박막의 조합으로 고속가공에 최적화 (Optimization for high speed machining due to combining the substrate of superior wear resistance and toughness with the coating of excellent thermal crack/plastic deformation)
	TC5120	P10~P20	YELLOW 	● CVD코팅(Coated) - MT-TiCN + α-Al2O3 + TiN
	TC5220	P10~P20	YELLOW - BLACK 	● CVD코팅(Coated) - MT-TiCN + α-Al2O3 + TiN + post blasting treatment ● 강의 중, 고속 가공용 (Medium to high speed machining of steel) ● 고인성모재와 내용착성, 내치핑성이 향상된 코팅 적용으로 범용 가공의 제 1차 추천가공 (First recommended grade for general machining with the use of high toughness substrate and coating layer with improved welding/chipping resistance)
	TC5230	P30~P40	YELLOW - BLACK 	● CVD코팅(Coated) - MT-TiCN + α-Al2O3 + TiN + post blasting treatment ● 강의 중, 저속 가공용 (Medium to low speed machining of steel)
M	TC6115	M10-M20	COPPER 	● CVD코팅(Coated) - MT-TiCN + α-Al2O3 ● 스테인레스강의 고속 가공용 (high speed machining of stainless steel)
	TC6125	M20-M30	BLACK 	● CVD코팅(Coated) - MT-TiCN + α-Al2O3 ● 스테인레스강의 고속 가공용 (high speed machining of stainless steel)
K	TC4105	K05~K10	BLACK 	● CVD코팅(Coated) - MT-TiCN + α-Al2O3 ● 주철의 고속/ 연속 가공용 (high speed machining of cast iron & continuous condition)
	TC4315	K10~K15	YELLOW - BLACK 	● CVD코팅(Coated) - MT-TiCN + α-Al2O3 + TiN ● 주철의 중고속 가공용 (Medium speed machining of cast iron)
	TC4215	K10~K15	BLACK 	● CVD코팅(Coated) - MT-TiCN + α-Al2O3 ● 주철의 중고속 가공용 (Medium speed machining of cast iron)
	TC4115D	K10~K15	BLACK 	● CVD코팅(Coated) - MT-TiCN + α-Al2O3 ● 주철 범용가공 1차 추천, 주철의 중고속 가공용 (Medium speed machining of cast iron)

TURNING

GROOVING

THREADING

MILLING

DRILLING

ENDMILLS

DRILLS

SPARE PARTS

INDEX

터너

더블칼라 재종 분석

[DOUBLE COLOR TC5210(20,30,40) CVD COATING MECHANISM]

그라운드

나사

미립

인테르메탈 드릴

엔드밀

속리드 드릴

파포

색인표

Double color CVD Film

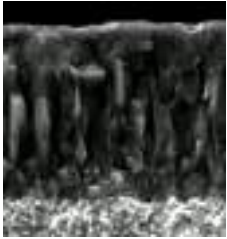

Cross sectional view

1. 미세 주상 조직 (New Coating with fine grain columnar structure)
 - 상면 블랙 + 옆면 노랑 코팅 (Only Side-TiN(Yellow) coating layer with lubrication.)
 - 강화된 α -Al₂O₃ layer 코팅 박막 (Excellent Hardness through improved α -Al₂O₃ layer)
 - 칩핑 방지 결합층 구조 (Bonding layer for anti chipping)
 - 미세 주상 조직의 MT-TiCN (MT-TiCN with fine grain columnar structure.)
2. 미세 모재 사용 Substrate with fine-finished surface
 - 강력한 모재 경도 Exclusive material with hardness
3. 전/후처리 공정 (Pre / Post - Treatment & Removing TiN layer on top side of insert)



소성변형 & 크레이터마모 & 칩핑 & 열변형 방지 (Prevent Crater wear, Thermal Stability, Chipping, Plastic deformation)



TC6125 재종분석 [TC6125 CVD COATING MECHANISM]

TC6125 CVD Coating

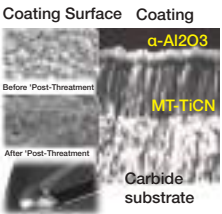

Cross sectional view

코팅 박막 특징 (Features of film)

- Special MT-TiCN
- Micro-grain α -Alumina

전 / 후 처리(Special Treatment for Coating)

- 전처리 (Pre-treatment)
 - 코팅 밀착력 강화 (Enhance Film Adhesion)
 - 박리저항성 증가 (Enhance Peeling Resistance)
 - 후처리 (Post-treatment)
 - 부드러운 표면 (Smooth & glossy Surface of Insert)
 - 두꺼운 코팅으로 긴수명 보장
- Lasting long tool life without Chipping & Built-up-edge

모재 특징 (Features of substrate)

- 고인성 모재 사용으로 고속 가공
- M20~30 carbide for high speed cutting of stainless steel

TC4115D,TC4215 재종분석[TC4115D & TC4215 CVD COATING MECHANISM]

TC4115D CVD Coating

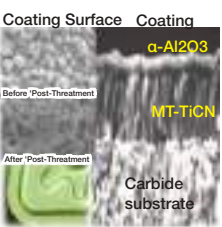

Cross sectional view

코팅 박막 특징 (Features of film)

- Special MT-TiCN
- Micro-grain α -Alumina

전 / 후 처리 공정 (Special Treatment for Coating)







- 전처리 (Pre-treatment)
 - 코팅 밀착력 강화 (Enhance Film Adhesion)
 - 박리저항성 증가 (Enhance Peeling Resistance)
 - 후처리 (Post-treatment)
 - 부드러운 표면 (Smooth & glossy Surface of Insert)
 - 두꺼운 코팅으로 긴수명 보장
- Lasting long tool life without Chipping & Built-up-edge

모재 특징 (Features of substrate)

낮은 코발트 함량으로 내마모성 증가 Hard micro-grain carbide with reducing cobalt

TURNING 터닝

PVD Turning Grades PVD 터닝 재종

Material 피삭재	Grade 재종	ISO 범위	Color 색깔	Operation 적용
M	TP0005P	M10-M15	COPPER 구리빛	<ul style="list-style-type: none"> ● PVD Salina 코팅(Cotated) - TiAlSiN coating (3-5μm) ● 미립모재 사용으로 내충격성 강화, 높은 온도에서 견딜수 있는 내열성 및 내산화성이 우수한 코팅 박막 Good wear resistance + Extremely heat & oxidation -resistance Reinforced shock resistance due to high Cobalt
				
	TP0005HP	M10-M15	COPPER 구리빛	<ul style="list-style-type: none"> ● PVD Salina 코팅(Coated) - AlCrN + AlCrSiN coating (3-5μm) ● sinter Hip 기술 적용으로 모재 성장 억제(2μm), 내충격성 강화 및 내열성, 내산화성이 우수한 코팅 박막 Reinforced shock resistance + Extremely heat & oxidation -resistance due to Sinter-hip technology
				
	TP0105P	M10-M15	BLACK 블랙	<ul style="list-style-type: none"> ● PVD new Balzers 코팅(Cotated) - ALTiN coating (3-5μm) ● 미립모재 사용으로 내충격성 강화, 높은 온도에서 견딜수 있는 내열성 및 내산화성이 우수한 코팅 박막 Reinforced shock resistance + Extremely heat & oxidation -resistance due to the micro substrate
				
	TP0010P	M15-M20	COPPER 구리빛	<ul style="list-style-type: none"> ● PVD Salina 코팅(Cotated) - TiAlSiN coating (3-5μm) ● 미립모재 사용으로 내충격성 강화, 높은 온도에서 견딜수 있는 내열성 및 내산화성이 우수한 코팅 박막 Good wear resistance + Extremely heat & oxidation -resistance Reinforced shock resistance due to high Cobalt
				
TP0015P	M20-M30	COPPER 구리빛	<ul style="list-style-type: none"> ● PVD Salina 코팅(Cotated) - TiAlSiN coating (3-5μm) ● 미립모재 사용으로 내충격성 강화, 높은 온도에서 견딜수 있는 내열성 및 내산화성이 우수한 코팅 박막 Good wear resistance + Extremely heat & oxidation -resistance Reinforced shock resistance due to high Cobalt 	
				
TP0115P	M20-M30	BLACK 블랙	<ul style="list-style-type: none"> ● PVD new Balzers 코팅(Cotated) - ALTiN coating (3-5μm) ● 강의 헤비절삭 가공용 (Heavy duty machining of steel) ● 스테레스강의 중,고속 가공용 (Medium to high speed machining of stainless steel) 	
				
TP0025	M25-M35	YELLOW 노랑	<ul style="list-style-type: none"> ● PVD 코팅(Cotated) - Tin + TiAlN coating (3-5μm) ● 보편적인 스테인레스 스틸용. 인성이 풍부한 재종으로 내충격성 강화 General stainless steel grade, Reinforced shock resistance 	
				

Uncoated Carbide Grades 초경 재종

Material 피삭재	Grade 재종	ISO 범위	Color 색깔	Operation 적용
N	TU4005	N05-N35	Silver 은색	<ul style="list-style-type: none"> ● 경면 처리 (비코팅), Polishing (UnCotated) ● AL 가공용 재종, 경면 처리를 통해 윤착 방지 (prevent blit-up edge for Aluminum)

Cermet Carbide Grades 써멧재종

Material 피삭재	Grade 재종	ISO 범위	Color 색깔	Operation 적용
UNI	TT5115	P10-P15	SILVER 은색	<ul style="list-style-type: none"> ● Non coated, for continuous machining of cold / hot forged steel 비코팅, 냉간단조, 열간단조, 저절입, 연속조건 용 ● Coated, Lubricant coating layer improves chip flow and reduce cutting force 코팅써멧, 윤활성 우수하여 칩처리 개선, 부하 방지
	TTP5115	P10-P15	YELLOW 노랑	

SALINA PVD 코팅 재종분석(SALINA PVD TP0005(15)P COATING MECHANISM)

PVD Coating FILM

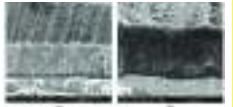

TiAlN Coating TiAlSiN Coating

Effect of coating treatment



Cross sectional view

코팅 박막 특징 (Features of film)

- TiAlSiN film coated (3-5 μ m)
- 내인성 증가 (Increased Toughness) + 내열성 & 내산화성 강화 (Extremely heat & oxidation -resistance)

모재 특징 (Features of substrate)

- 미립 모재 사용 (Micro-grain carbide (Under 3 μ m))
- 코발트 비율 증가로 내충격성 강화 Reinforced shock resistance due to high Cobalt

적용 피삭재 (Available workpiece)

- 스테인레스 스틸/Stainless steel (AISI 300, 400 / X,Z-□ Cr, Ni)
- 내열강 합금강 (High temp. alloy)



TP0105P 재종분석(New balzers PVD TP0105(15)P COATING MECHANISM)

PVD Coating FILM

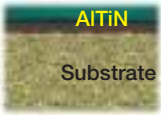

Effect of coating treatment



Before Post-Treatment After Post-Treatment

Cross sectional view

코팅 박막 특징 (Features of film)

- AlTiN 코팅 박막 적용 (Enhanced AlTiN film coated (3-5 μ m))
- 내인성 증가 (Good wear resistance) + 내열성 & 내산화성 강화 (Extremely heat & oxidation -resistance)

전 / 후 처리(Special Treatment for Coating)

	Photo After Test	Adehesion Index
TP0115P		48/100
Swe S Maker		27/100
Jap K Maker		9/100
Kor T Maker		24/100

TP0005HP재종분석 (NEW PVD TP0005HP COATING MECHANISM)

TP0005HP Substrate

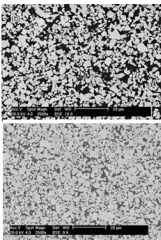

Sinter Hip EFFECT !!

코팅 박막 특징 (Features of film)

- 신규 박막 적용 ,AlCrN + AlCrSiN film coated (3-5 μ m)
- 내인성 증가 (Good wear resistance) + 내열성 & 내산화성 강화 (Extremely heat & oxidation -resistance)

모재 특징 (Features of substrate)

- 신터힙처리, Sinter-Hip Micro-grain carbide (Under 2 μ m)
- 용착 및 소성 변형 방지 Prevent Plastic deformation & Built-up edge

적용 피삭재 (Available workpiece)

- Stainless steel AISI 300, 400 / X,Z-□ Cr, Ni
- 난삭재 (인코넬, 티타늄 합금등) Pre-hardened steel

범용 TP0025재종분석(UNIVERSAL PVD TP0025 COATING MECHANISM)

TP0025 Substrate



Structure of Coating

코팅 박막 특징 (Features of film)

- TiN + TiAlN film coated (3-5 μ m)
- 내마모성 증가 Good wear resistance + 윤활성 강화로 파손 방지 Reduce the friction due to adding TiN coating























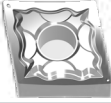
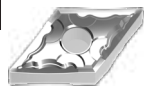

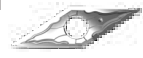





























모재 특징 (Features of substrate)

- 미립 모재 사용 Micro-grain carbide (Under 3 μ m)
- 내충격성 강화 Reinforced shock resistance due to high Cobalt

적용 피삭재 (Available workpiece)





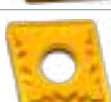























































- 스테인레스 스틸/Stainless steel (AISI 300, 400 / X,Z-□ Cr, Ni)
- 내열강 합금강 (High temp. alloy)

Chipbreakers Selection / 칩브레이커 영역 (Negative / 네가티브)

	CN	DN	SN	TN	VN	WN
MA FLAT	25 	33 	40 	48 		61 
MG BOX	25 	33 	40 	48 	58 	61 
A3				48 		
AU	25 	33 	40 	48 	58 	61 
HA			40 			
GH				49 		61 
MF	25 	33 	41 	49 	58 	61 
MF2	25 	33 		49 	58 	61 
MF3	26 	34 	41 	49 	58 	61 
MF4	26 	34 		49 		62 
MM	26 	34 	41 	49 	58 	62 
MM2	26 	34 	41 	50 	59 	62 
MM3	26 					62 
MM4	27 					











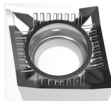
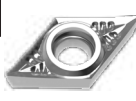





















- TURNING
- GROOVING
- THREADING
- MILLING
- DRILLING
- ENDMILLS
- DRILLS
- SPARE PARTS
- INDEX

Chipbreakers Selection / 칩브레이커 영역 (Negative / 네가티브)

	CN	DN	SN	TN	VN	WN
MR	27 	34 	41 	50 		62 
MS	27 	35 	42 	50 	59 	62 
RB-25	27 		42 			
RH-25	27 		42 			
TQ				50 		63 
UF	28 	35 	42 	50 	59 	63 
UF1	28 	35 	43 	50 		63 
UM	28 	35 	43 	51 	59 	63 
UM1	28 	35 	43 	51 	59 	63 
UMC	29 	36 	43 	51 	60 	63 
UR	29 	36 	44 	52 		64 
UR1	29 	36 	44 	52 	60 	64 
Z						64 
L-R		33 		48 		













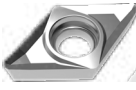















- 터닝
- 그루닝
- 나사
- 밀링
- 인테셔널 드릴
- 엔드밀
- 솔리드 드릴
- 부품
- 색인표

Chipbreakers Selection / 칩브레이커 영역(Positive / 포지티브)

	CC	DC	SC	TC	VB	VC
AU	22 	30 		45 	54 	56 
AU2C						56 
AUP						56 
GM	22 	30 		45 	54 	
MF	22 	30 			54 	
MF1	22 	31 		45 		56 
MF2	22 					
MM					54 	
MM1	23 	31 		45 	54 	56 
MM3	23 	31 			55 	
MM4					55 	
MM5	23 	31 		46 		
MR		31 				
SF		30 				

- TURNING
- GROOVING
- THREADING
- MILLING
- DRILLING
- ENDMILLS
- DRILLS
- SPARE PARTS
- INDEX

Chipbreakers Selection / 칩브레이커 영역 (Positive / 포지티브)

	CC	DC	SC	TC	VB	VC
SF-OK		30 				57 
SL		30 				
TQ	23 					
UF	23 	31 		46 	55 	57 
UM	24 	32 	39 	46 	55 	57 
UM2	24 	32 		47 		
UR	24 	32 	39 	47 	55 	57 
UR2	24 	32 	39 	47 	55 	

Machining Examples 가공 사례

P 탄소강(Carbon Steel / S45C)	
■ 피삭재 (Workpiece)	허브 (Hub)
■ 절삭조건 (Cutting Conditions)	Vc (m/min)= 250
	fn (mm/rev)= 0.2
	ap (mm)= 1,5
	Wet
■ 형번 (Designation)	제품 (Insert) CNMG120408-UM TC5210
	홀더 (Tool Holder) TCLNR2525-M12
■ 결과 (Test result)	

P 합금강 (Alloy Steel / SCM440)	
■ 피삭재 (Workpiece)	자동차부품(Automobile Part)
■ 절삭조건 (Cutting Conditions)	Vc (m/min)= 250
	fn (mm/rev)= 0.2
	ap (mm)= 1,5
	Wet
■ 형번 (Designation)	제품 (Insert) CNMG120408-UMC TC5220
	홀더 (Tool Holder) TCLNR2525-M12
■ 결과 (Test result)	

M 스텐레스 스틸 (SUS316L)	
■ 피삭재 (Workpiece)	밸브 (Valve)
■ 절삭조건 (Cutting Conditions)	Vc (m/min)= 120
	fn (mm/rev)= 0.2
	ap (mm)= 1,5
	Wet
■ 형번 (Designation)	제품 (Insert) CNMG120408-MM TP0115P
	홀더 (Tool Holder) TCLNR2525-M12
■ 결과 (Test result)	

K 회주철 (Gray Cast Iron / FC25)	
■ 피삭재 (Workpiece)	디스크 (Disk)
■ 절삭조건 (Cutting Conditions)	Vc (m/min)= 350
	fn (mm/rev)= 0.25
	ap (mm)= 1,5
	Wet
■ 형번 (Designation)	제품 (Insert) CNMA120408 TC4115D
	홀더 (Tool Holder) TCLNR2525-M12
■ 결과 (Test result)	

TURNING

GROOVING

THREADING

MILLING

DRILLING

ENDMILLS

DRILLS

SPARE PARTS

INDEX

RANGE / 적용 영역

ISO **K** 주철

Grades / 재종

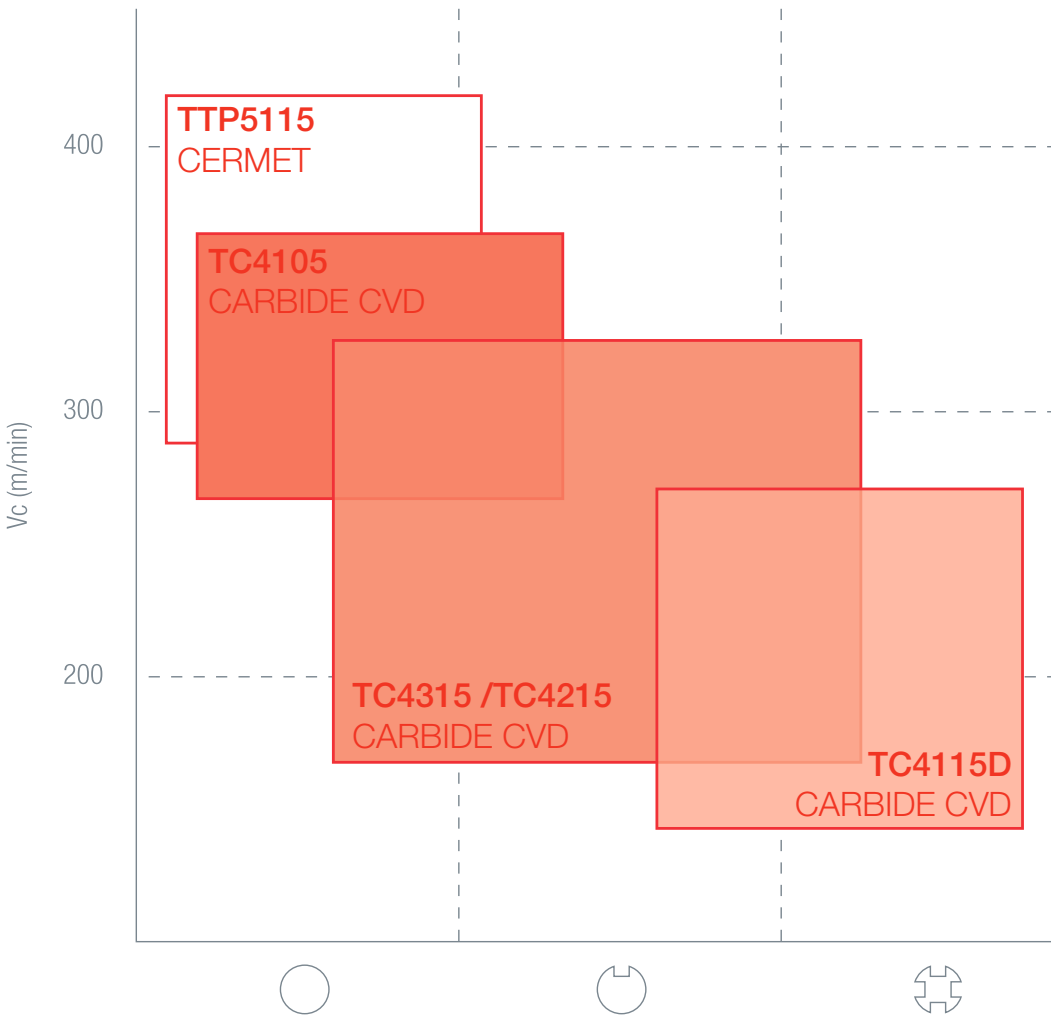

TURNING 터닝

RANGE / 적용 영역 ISO **P** 강용

Grades / 재종

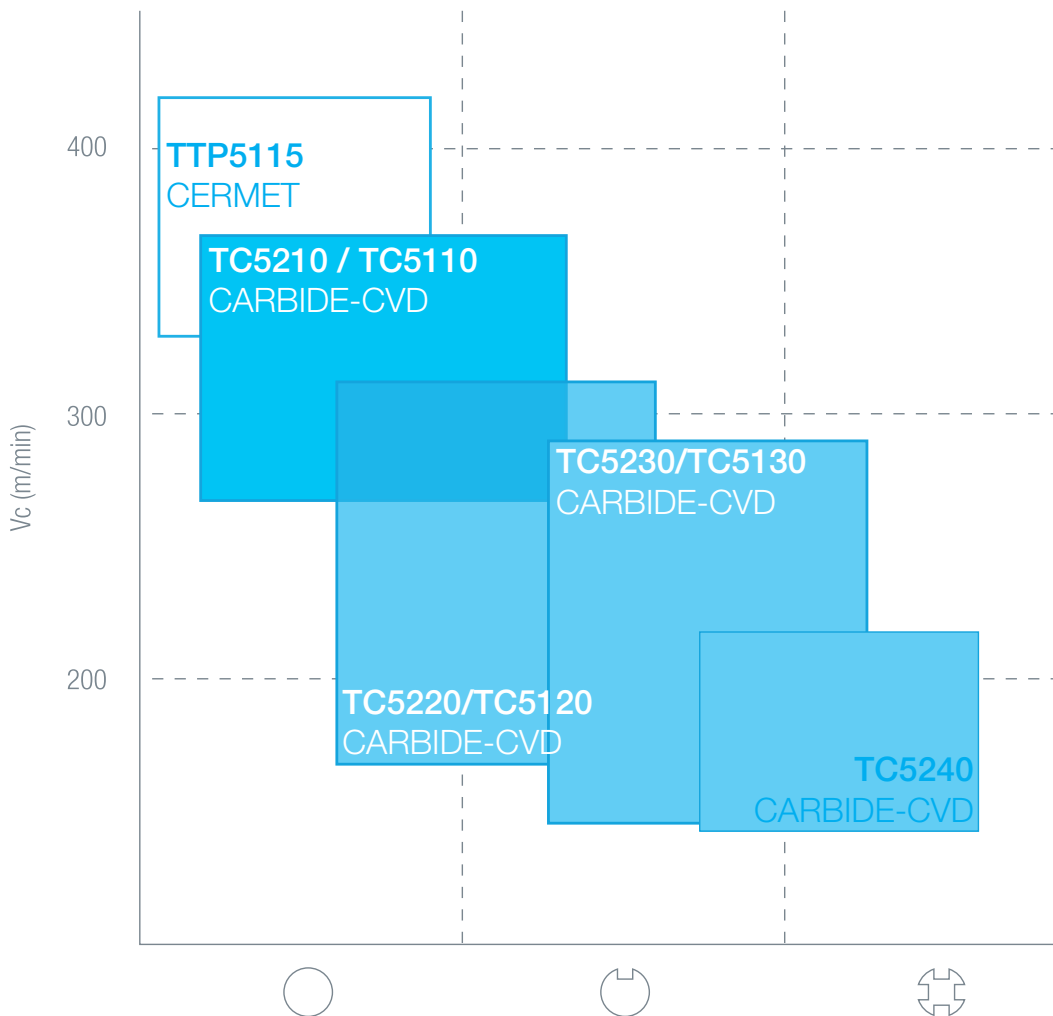

TURNING

GROOVING

THREADING

MILLING

DRILLING

ENDMILLS

DRILLS

SPARE PARTS

INDEX

Range / 적용 영역

ISO **M** 스테인레스용

Grades / 재종

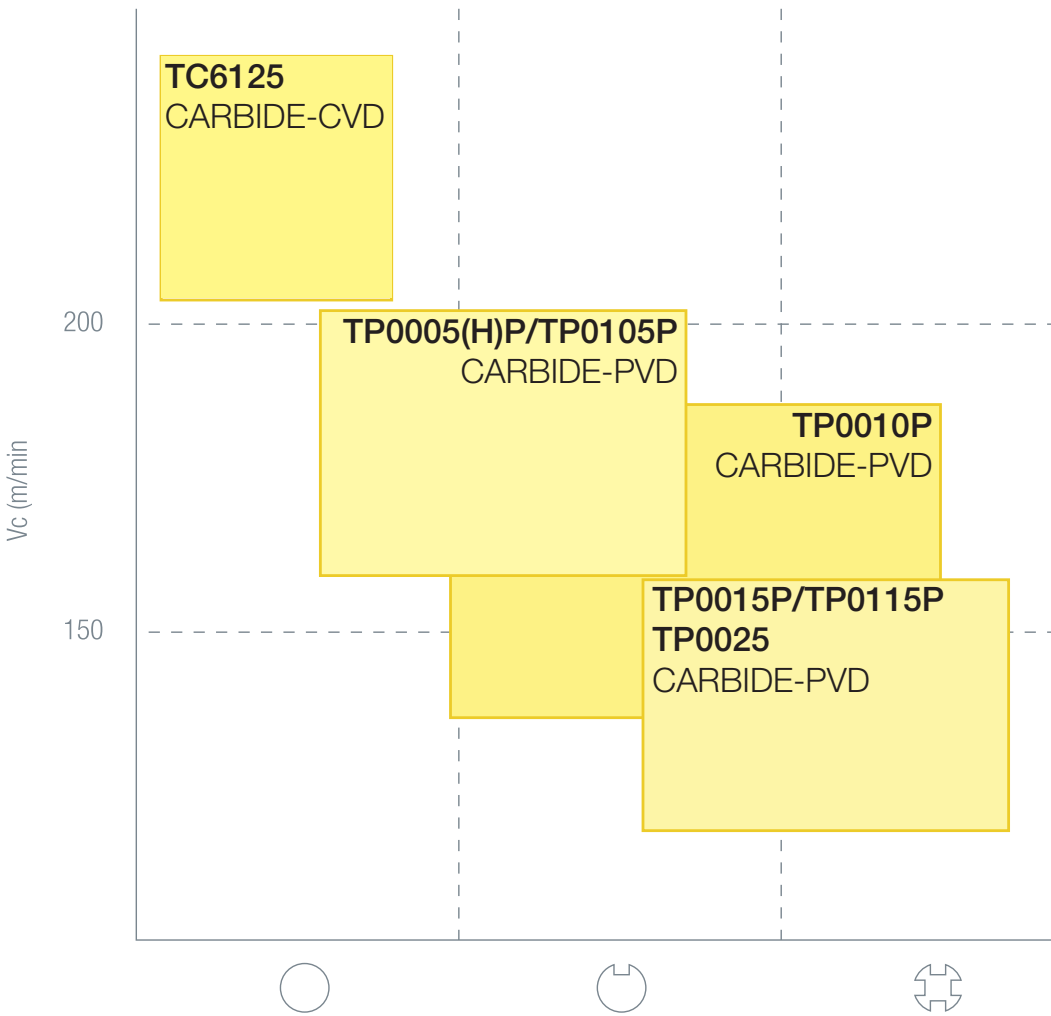

TURNING 터닝

Range / 적용 영역 ISO **N** 비철금속용

Grades / 재종

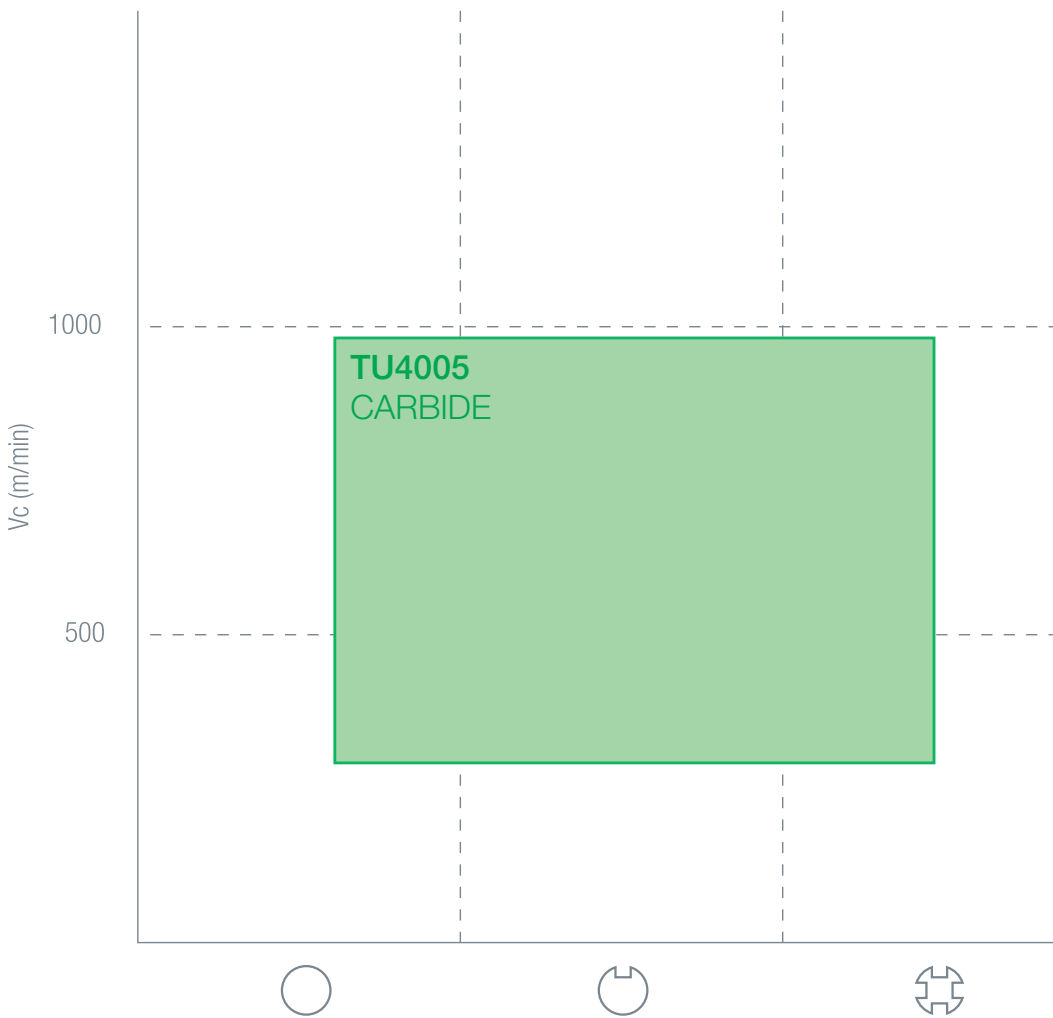

TURNING

GROOVING

THREADING

MILLING

DRILLING

ENDMILLS

DRILLS

SPARE PARTS

INDEX

터닝

그루브

나사

미립

인테서블 드릴

엔드밀

솔리드 드릴

부품

색인표

POSITIVE 7°
with hole

CC□□

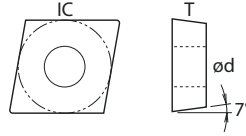
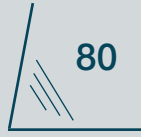

CC	0602	09T3	1204
IC	6,35	9,525	12,7
T	2,38	3,97	4,76
Ød	2,80	4,40	5,50
Holder	120	120	120

DESCRIPTION 형번	CARBIDE-CVD CVD코팅								CARBIDE-PVD PVD코팅					CERMET 세멧 (비코 팅,코팅)	CARBIDE 초경							
	TC5110	TC5210	TC5120	TC5220	TC5230	TC4105	TC4115D	TC4215	TC4315	TC6125	TP0005P	TP0105P	TP0010P	TP0015P	TP0115P	TP0025	TP0005HP	TT5115	TTP5115	TU4005		
	CCGT060202-AU																				●	
	CCGT060204-AU																					●
	CCGT060208-AU																					●
	CCGT09T302-AU																					●
	CCGT09T304-AU																					●
	CCGT09T308-AU																					●
	CCGT120402-AU																					●
	CCGT120404-AU																					●
	CCMT060204-GM												●	●							●	
	CCMT09T304-GM												●	●							●	
	CCMT09T308-GM												●	●							●	
	CCMT060202-MF														●						●	
	CCMT060204-MF														●	●					●	
	CCMT09T302-MF														●	●					●	
	CCMT060202-MF1	●		●								●	●	●							●	
	CCMT060204-MF1	●		●									●	●	●		●				●	
	CCMT09T302-MF1	●		●									●	●	●						●	
	CCMT09T304-MF1											●	●	●			●				●	
	CCMT060204-MF2									●			●	●							●	
	CCMT09T304-MF2										●	●	●	●							●	
	CCMT120404-MF2												●	●							●	

finishing
 medium
 roughing

Vc ● fn ● ap

70

TURNING 터닝

POSITIVE 7°
with hole

CC□□

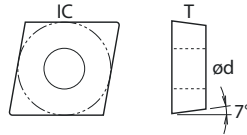
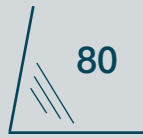

CC	0602	09T3	1204
IC	6,35	9,525	12,7
T	2,38	3,97	4,76
Ød	2,80	4,40	5,50
Holder	120	120	120

DESCRIPTION 형번		CARBIDE-CVD CVD코팅								CARBIDE-PVD PVD코팅						CERMET 세멧 (비코팅, 코팅)		CARBIDE 초경						
		TC5110	TC5210	TC5120	TC5220	TC5230	TC4105	TC4115D	TC4215	TC4315	TC6125	TP0005P	TP0105P	TP0010P	TP0015P	TP0115P	TP0025	TP0005HP	TT5115	TTP5115	TU4005			
		CCMT060204-MM1	●		●				●					●	●	●		●						
		CCMT060208-MM1	●		●			●	●					●	●	●			●					
		CCMT09T302-MM1			●										●	●								
		CCMT09T304-MM1	●		●			●	●	●		●		●	●	●			●					
		CCMT09T308-MM1	●		●			●	●	●		●		●	●	●			●					
		CCMT120404-MM1	●		●				●					●	●	●			●					
		CCMT120408-MM1	●		●				●					●	●	●			●					
		CCMT120412-MM1	●		●				●						●	●			●					
		CCMT060208-MM3												●	●									
		CCMT09T304-MM3												●				●						
		CCMT060204-MM5															●							
		CCMT060208-MM5															●							
		CCMT09T302-MM5															●							
		CCMT09T304-MM5															●							
		CCMT09T308-MM5															●							
		CCMT120404-MM5															●							
		CCMT120408-MM5															●							
		CCMT120412-MM5															●							
		CCMT060204-TQ	●		●									●	●	●								
		CCMT09T304-TQ	●		●										●	●								
		CCMT060202-UF		●		●	●																	
		CCMT060204-UF		●		●	●																	
		CCMT060208-UF		●		●	●																	
		CCMT09T302-UF		●		●	●																	

finishing
 medium
 roughing

Vc ● fn ● ap 70

- TURNING
- GROOVING
- THREADING
- MILLING
- DRILLING
- ENDMILLS
- DRILLS
- SPARE PARTS
- INDEX

터닝

그루브

나사

민삭

인테서블 드릴

엔드밀

슬리드 드릴

부품

색인표

POSITIVE 7°
with hole

CC□□

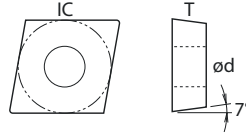

CC	0602	09T3	1204
IC	6,35	9,525	12,7
T	2,38	3,97	4,76
Ød	2,80	4,40	5,50
Holder	120	120	120

DESCRIPTION 형번	CARBIDE-CVD CVD코팅								CARBIDE-PVD PVD코팅						CERMET 세멧 (비코 팅, 코팅)	CARBIDE 조경					
	TC5110	TC5210	TC5120	TC5220	TC5230	TC4105	TC4115D	TC4215	TC4315	TC6125	TP0005P	TP0105P	TP0010P	TP0015P	TP0115P	TP0025	TP0005HP	TT5115	TTP5115	TU4005	
	CCMT09T304-UF	●		●	●																
	CCMT120404-UF	●		●	●																
	CCMT120408-UF	●		●	●																
	CCMT060204-UM	●		●	●																
	CCMT060208-UM	●		●	●																
	CCMT09T302-UM	●		●	●																
	CCMT09T304-UM	●		●	●																
	CCMT09T308-UM	●		●	●																
	CCMT120404-UM	●		●	●																
	CCMT120408-UM	●		●	●																
	CCMT120412-UM	●		●	●																
	CCMT060204-UM2	●		●									●	●							
	CCMT060208-UM2	●		●									●	●							
	CCMT09T304-UM2	●		●									●	●							
	CCMT09T308-UM2	●		●									●	●							
	CCMT120404-UM2	●		●									●	●							
	CCMT120408-UM2	●		●									●	●			●				
	CCMT060208-UR				●	●															
	CCMT09T308-UR		●		●	●															
	CCMT120408-UR		●		●	●															
	CCMT120412-UR				●	●															
	CCMT060208-UR2	●		●				●					●								
	CCMT09T308-UR2	●		●				●					●	●							
	CCMT120408-UR2	●		●				●					●				●				

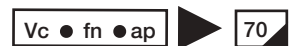

TURNING 터닝

NEGATIVE
with hole

CN□□

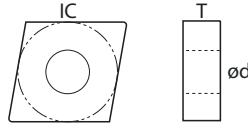

CN	1204	1606	1906
IC	12,7	15,875	12,7
T	4,76	6,35	4,76
ød	5,16	6,35	5,50
Holder	125	125	125

DESCRIPTION 형번		CARBIDE-CVD CVD코팅								CARBIDE-PVD PVD코팅						CERMET 세멧 (비코 팅, 코팅)		CARBIDE 초경					
		TC5110	TC5210	TC5120	TC5220	TC5230	TC4105	TC4115D	TC4215	TC4315	TC6125	TP0005P	TP0105P	TP0010P	TP0015P	TP0115P	TP0025	TP0005HP	TT5115	TTP5115	TU4005		
		CNMA120404					●	●	●	●													
		CNMA120408						●	●	●	●												
		CNMA120412						●	●	●	●												
		CNMA160608						●	●	●	●												
		CNMA160612						●	●	●	●												
		CNMA160616						●	●	●	●												
		CNMG120404					●	●	●	●													
		CNMG120408						●	●	●	●												
		CNMG120412						●	●	●	●												
		CNMG120416						●	●	●	●												
		CNMG160608						●	●	●	●												
		CNMG160612						●	●	●	●												
		CNMG160616						●	●	●	●												
		CNMG190608						●	●	●	●												
		CNMG190612						●	●	●	●												
CNMG190616						●	●	●	●														
		CNMG120404-AU																				●	
		CNMG120408-AU																					●
		CNMG090308-MF															●						
		CNMG120404-MF																●					
		CNMG120408-MF																●					
		CNMG090308-MF2													●								
		CNMG120404-MF2									●				●	●							
		CNMG120408-MF2													●								

finishing
 medium
 roughing

Vc ● fn ● ap 66

- TURNING
- GROOVING
- THREADING
- MILLING
- DRILLING
- ENDMILLS
- DRILLS
- SPARE PARTS
- INDEX

터닝
그루브
나사
면밀
인테셔널 드릴
엔드밀
솔리드 드릴
부품
색인표

NEGATIVE
with hole

CN□□

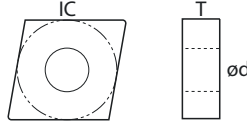
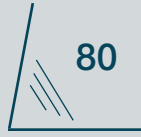

CN	0904	1204	1606
IC	9,525	12,7	15,875
T	4,76	4,76	6,35
ød	3,81	5,16	6,35
Holder	125	125	125

DESCRIPTION 형번	CARBIDE-CVD CVD코팅								CARBIDE-PVD PVD코팅						CERMET 세멧 (비코 팅,코팅)		CARBIDE 초경					
	TC5110	TC5210	TC5120	TC5220	TC5230	TC4105	TC4115D	TC4215	TC4315	TC6125	TP0005P	TP0105P	TP0010P	TP0015P	TP0115P	TP0025	TP0005HP	TT5115	TTP5115	TU4005		
	CNMG090308-MF3																					
	CNMG120408-MF3										●				●	●						
	CNMG120412-MF3														●	●						
	CNMG160612-MF3														●	●						
	CNMG120404-MF4									●		●		●	●							
	CNMG090408-MM															●						
	CNMG090412-MM															●						
	CNMG120404-MM	●	●	●	●	●								●	●	●						
	CNMG120408-MM	●	●	●	●	●								●	●	●						
	CNMG120412-MM		●		●	●										●						
	CNMG160608-MM		●		●	●										●						
	CNMG160612-MM															●						
	CNMG160616-MM															●						
	CNMG190608-MM															●						
CNMG190612-MM															●							
	CNMG120404-MM2	●		●						●				●	●		●					
	CNMG120408-MM2	●		●						●				●	●		●					
	CNMG120404-MM3													●			●					
	CNMG120408-MM3													●			●					

finishing medium roughing

Vc ● fn ● ap 66

TURNING 터닝

NEGATIVE
with hole

CN□□

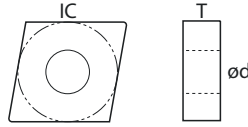

CN	1204	1606	1906
IC	12,7	15,875	12,7
T	4,76	6,35	4,76
ød	5,16	6,35	5,50
Holder	125	125	125

DESCRIPTION 형번	CARBIDE-CVD CVD코팅				CARBIDE-PVD PVD코팅								CERMET 세멧 (비코 팅, 코팅)	CARBIDE 조경									
	TC5110	TC5210	TC5120	TC5220	TC5230	TC4105	TC4115D	TC4215	TC4315	TC6125	TP0005P	TP0105P	TP0010P	TP0015P	TP0115P	TP0025	TP0005HP	TT5115	TTP5115	TU4005			
	CNMG120408-MM4										●		●	●									
	CNMG120412-MM4										●		●	●									
	CNMG120408-MR															●							
	CNMG120412-MR															●							
	CNMG160616-MR															●							
	CNMG160624-MR															●							
	CNMG190612-MR															●							
	CNMG190616-MR															●							
	CNMG120404-MS												●	●		●							
	CNMM190612-RB25			●	●																		
	CNMM190616-RB25			●	●																		
	CNMM190624-RB25			●	●																		
	CNMM250724-RB25			●	●																		
	CNMM250924-RB25			●	●																		
	CNMM190612-RH25			●	●																		
	CNMM190616-RH25			●	●																		
	CNMM190624-RH25			●	●																		
	CNMM250724-RH25			●	●																		
	CNMM250924-RH25			●	●																		

finishing
 medium
 roughing

Vc ● fn ● ap 66

- TURNING
- GROOVING
- THREADING
- MILLING
- DRILLING
- ENDMILLS
- DRILLS
- SPARE PARTS
- INDEX

터닝

그루브

나사

면밀

인테서블 드릴

엔드밀

슬리드 드릴

부품

색인표

NEGATIVE
with hole

CN□□

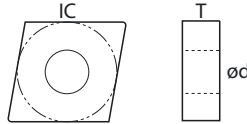

CN	0904	1204	1606
IC	9,525	12,7	15,875
T	4,76	4,76	6,35
ød	3,81	5,16	6,35
Holder	125	125	125

DESCRIPTION 형번	CARBIDE-CVD CVD코팅				CARBIDE-PVD PVD코팅						CERMET 세멧 (비코팅, 코팅)		CARBIDE 초경								
	TC5110	TC5210	TC5120	TC5220	TC5230	TC4105	TC4115D	TC4215	TC4315	TC6125	TP0005P	TP0105P	TP0010P	TP0015P	TP0115P	TP0025	TP0005HP	TT5115	TTP5115	TU4005	
	CNMG090304-UF	●		●	●																
	CNMG090308-UF	●		●	●																
	CNMG120404-UF		●		●	●															
	CNMG120408-UF		●		●	●															
	CNMG120412-UF				●	●															
	CNMG090408-UF1			●																	
	CNMG120404-UF1	●		●																	
	CNMG120408-UF1	●		●																	
	CNMG090304-UM		●		●	●															
	CNMG090308-UM		●		●	●															
	CNMG120404-UM		●		●	●															
	CNMG120408-UM		●		●	●															
	CNMG120412-UM		●		●	●															
	CNMG160608-UM		●		●	●															
	CNMG160612-UM		●		●	●															
	CNMG160616-UM		●		●	●															
	CNMG190608-UM		●		●	●															
	CNMG190612-UM		●		●	●															
	CNMG190616-UM		●		●	●															
	CNMG090408-UM1			●																	
	CNMG090412-UM1			●																	
	CNMG120404-UM1	●		●				●					●	●	●						
	CNMG120408-UM1	●		●				●					●	●							
	CNMG120412-UM1	●		●																	
	CNMG160608-UM1							●													
	CNMG160612-UM1	●		●				●													
	CNMG160616-UM1	●		●				●													

finishing
 medium
 roughing

Vc ● fn ● ap

66

TURNING 터닝

NEGATIVE
with hole

CN□□

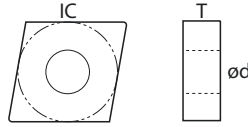

CN	1204	1606	1906
IC	12,7	15,875	12,7
T	4,76	6,35	4,76
ød	5,16	6,35	5,50
Holder	125	125	125

DESCRIPTION 형번		CARBIDE-CVD CVD코팅								CARBIDE-PVD PVD코팅						CERMET 세멧 (비코 팅, 코팅)	CARBIDE 조경							
		TC5110	TC5210	TC5120	TC5220	TC5230	TC4105	TC4115D	TC4215	TC4315	TC6125	TP0005P	TP0105P	TP0010P	TP0015P	TP0115P	TP0025	TP0005HP	TT5115	TTP5115	TU4005			
		CNMG190608-UM1			●																			
		CNMG190612-UM1			●																			
		CNMG190616-UM1			●																			
		CNMG120404-UMC	●	●	●	●	●																	
		CNMG120408-UMC	●	●	●	●	●																	
		CNMG120412-UMC	●	●	●	●	●																	
		CNMG160608-UMC	●	●	●	●	●																	
		CNMG120408-UR		●		●	●																	
		CNMG120412-UR		●		●	●																	
		CNMG120416-UR				●	●																	
		CNMG160612-UR		●		●	●																	
		CNMG160608-UR				●	●																	
		CNMG160612-UR		●		●	●																	
		CNMG160616-UR		●		●	●																	
		CNMG160624-UR		●		●	●																	
		CNMG190612-UR		●		●	●																	
		CNMG190616-UR				●	●																	
		CNMG120408-UR1	●		●										●									
		CNMG120412-UR1			●																			
		CNMG160612-UR1	●		●											●								
		CNMG160616-UR1	●		●																			
		CNMG160624-UR1			●																			
		CNMG190612-UR1	●		●																			
		CNMG190616-UR1	●		●											●								
		CNMG190624-UR1			●																			

finishing medium roughing

Vc ● fn ● ap 66

- TURNING
- GROOVING
- THREADING
- MILLING
- DRILLING
- ENDMILLS
- DRILLS
- SPARE PARTS
- INDEX

터닝

그루브

나사

밀링

인테서블 드릴

엔드밀

슬리드 드릴

부품

색인표

**POSITIVE 7°
with hole**

DC □ □ □

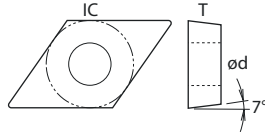

DC	0702	11T3
IC	6,35	9,525
T	2,38	3,97
Ød	2,80	4,40
Holder	133	133

DESCRIPTION 형번	CARBIDE-CVD CVD코팅								CARBIDE-PVD PVD코팅						CERMET 세멧 (비코팅, 코팅)		CARBIDE 초경						
	TC5110	TC5210	TC5120	TC5220	TC5230	TC4105	TC4115D	TC4215	TC4315	TC6125	TP0005P	TP0105P	TP0010P	TP0015P	TP0115P	TP0025	TP0005HP	TT5115	TTP5115	TU4005			
	DCGT070202-AU																					●	
	DCGT070204-AU																						●
	DCGT070208-AU																						●
	DCGT11T302-AU																						●
	DCGT11T304-AU																						●
	DCGT11T308-AU																						●
	DCGT11T312-AU																						●
	DCGT11T302-SF																					●	
	DCGT11T304-SF																						●
	DCGT11T302-SF-OK										●			●								●	
	DCGT11T304-SF-OK										●			●									●
	DCGT11T302-SL																					●	
	DCGT11T304-SL																						●
	DCMT11T304-GM													●	●							●	
	DCMT11T308-GM													●	●								●
	DCMT070202-MF																●					●	
	DCMT070204-MF																	●					●
	DCMT11T302-MF																	●					●
	DCMT11T304-MF																	●					●

finishing
 medium
 roughing

Vc ● fn ● ap

70

TURNING 터닝

POSITIVE 7°
with hole

DC□□

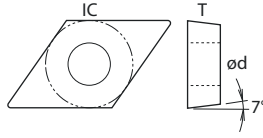

DC	0702	11T3
IC	6,35	9,525
T	2,38	3,97
Ød	2,80	4,40
Holder	133	133

DESCRIPTION 형번		CARBIDE-CVD CVD코팅								CARBIDE-PVD PVD코팅						CERMET 세멧 (비코 팅, 코팅)	CARBIDE 조경					
		TC5110	TC5210	TC5120	TC5220	TC5230	TC4105	TC4115D	TC4215	TC4315	TC6125	TP0005P	TP0105P	TP0010P	TP0015P	TP0115P	TP0025	TP0005HP	TT5115	TTP5115	TU4005	
	DCMT070202-MF1			●											●	●						
	DCMT070204-MF1			●											●	●						
	DCMT11T302-MF1			●											●							
	DCMT11T304-MF1	●		●											●	●						
	DCMT070204-MM1	●		●										●	●							
	DCMT070208-MM1	●		●										●	●							
	DCMT11T304-MM1	●		●				●						●	●			●				
	DCMT11T308-MM1	●		●			●	●						●	●			●				
	DCMT11T304-MM3													●			●					
	DCMT070204-MM5																●					
	DCMT070208-MM5																●					
	DCMT11T302-MM5																●					
	DCMT11T304-MM5																●					
	DCMT11T308-MM5																●					
	DCMT11T304-MR																●					
	DCMT11T308-MR																●					
	DCMT070202-UF		●		●	●																
	DCMT070204-UF		●		●	●																
	DCMT11T302-UF		●		●	●																
	DCMT11T304-UF		●		●	●																
	DCMT11T308-UF		●		●	●																

finishing
 medium
 roughing

Vc ● fn ● ap 70

- TURNING
- GROOVING
- THREADING
- MILLING
- DRILLING
- ENDMILLS
- DRILLS
- SPARE PARTS
- INDEX

터닝

그루브

나사

면밀

인테서블 드릴

엔드밀

솔리드 드릴

부품

색인표

POSITIVE 7°
with hole

DC□□

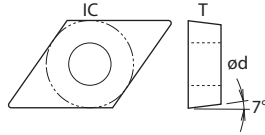

DC	0702	11T3
IC	6,35	9,525
T	2,38	3,97
Ød	2,80	4,40
Holder	133	133

DESCRIPTION 형번	CARBIDE-CVD CVD코팅								CARBIDE-PVD PVD코팅						CERMET 세멧 (비코팅, 코팅)		CARBIDE 초경					
	TC5110	TC5210	TC5120	TC5220	TC5230	TC4105	TC4115D	TC4215	TC4315	TC6125	TP0005P	TP0105P	TP0010P	TP0015P	TP0115P	TP0025	TP0005HP	TT5115	TTP5115	TU4005		
	DCMT070204-UM	●		●	●																	
	DCMT070208-UM	●			●	●																
	DCMT11T302-UM		●		●	●																
	DCMT11T304-UM		●		●	●																
	DCMT11T308-UM		●		●	●																
	DCMT11T312-UM		●		●	●																
	DCMT11T304-UM2	●		●										●	●							
	DCMT11T308-UM2	●		●										●	●							
	DCMT11T304-UR				●	●																
	DCMT11T308-UR				●	●																
	DCMT11T304-UR2			●			●							●	●							



Vc ● fn ● ap ▶ 70

TURNING 터닝

NEGATIVE
with hole

DN□□

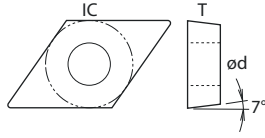

DN	1104	1504	1506
IC	9,525	12,7	12,7
T	4,76	4,76	6,35
Ød	3,81	5,16	5,16
Holder	142	142	142

DESCRIPTION 형번		CARBIDE-CVD CVD코팅								CARBIDE-PVD PVD코팅						CERMET 세멧 (비코팅, 코팅)		CARBIDE 조경				
		TC5110	TC5210	TC5120	TC5220	TC5230	TC4105	TC4115D	TC4215	TC4315	TC6125	TP0005P	TP0105P	TP0010P	TP0015P	TP0115P	TP0025	TP0005HP	TT5115	TTP5115	TU4005	
	DNMA150608						●	●	●	●												
	DNMA150612						●	●	●	●												
	DNMA150616						●	●	●	●												
	DNMG110408						●	●	●	●												
	DNMG150404						●	●	●	●												
	DNMG150408						●	●	●	●												
	DNMG150412						●	●	●	●												
	DNMG150604						●	●	●	●												
	DNMG150608						●	●	●	●												
	DNMG150612						●	●	●	●												
DNMG150616						●	●	●	●													
	DNMX150604L	●		●										●								
	DNMX150604R	●		●										●								
	DNMX150608L	●		●										●								
	DNMX150608R	●		●										●								
	DNMG150404-AU																					●
	DNMG150408-AU																					●
	DNMG150604-AU																					●
	DNMG150608-AU																					●
	DNMG150604-MF																●					
	DNMG150608-MF																●					
	DNMG110404-MF2																					
	DNMG150404-MF2	●		●																		
	DNMG150408-MF2																					

finishing
 medium
 roughing

Vc ● fn ● ap 66

TURNING
GROOVING
THREADING
MILLING
DRILLING
ENDMILLS
DRILLS
SPARE PARTS
INDEX

터닝

그루브

나사

면밀

인테서블 드릴

엔드밀

슬리드 드릴

부품

색인표

**NEGATIVE
with hole**

DN□□

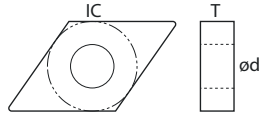

DN	1104	1504	1506
IC	9,525	12,7	12,7
T	4,76	4,76	6,35
Ød	3,81	5,16	5,16
Holder	142	142	142

DESCRIPTION 형번	CARBIDE-CVD CVD코팅								CARBIDE-PVD PVD코팅						CERMET 세멧 (비코팅, 코팅)		CARBIDE 초경						
	TC5110	TC5210	TC5120	TC5220	TC5230	TC4105	TC4115D	TC4215	TC4315	TC6125	TP0005P	TP0105P	TP0010P	TP0015P	TP0115P	TP0025	TP0005HP	TT5115	TTP5115	TU4005			
	DNMG150408-MF3									●					●	●							
	DNMG150608-MF3									●						●	●						
	DNMG150604-MF4														●	●							
	DNMG150608-MF4														●	●							
	DNMG110404-MM															●							
	DNMG110408-MM		●		●	●										●	●						
	DNMG150404-MM		●		●	●										●	●						
	DNMG150408-MM															●	●						
	DNMG150412-MM															●	●						
	DNMG150604-MM		●		●	●										●	●						
	DNMG150608-MM		●		●	●										●	●						
	DNMG150612-MM															●	●						
	DNMG110404-MM2	●		●											●								
	DNMG110408-MM2	●		●											●	●							
	DNMG150404-MM2									●					●	●							
	DNMG150408-MM2									●					●	●							
	DNMG150604-MM2	●		●											●	●							
	DNMG150608-MM2	●		●											●	●		●					
	DNMG150612-MM2														●	●							
	DNMG150412-MR															●	●						
	DNMG150608-MR														●	●							
	DNMG150612-MR														●	●							
															●	●							



TURNING 터닝

NEGATIVE
with hole

DN□□

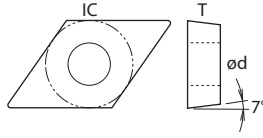

DN	1104	1504	1506
IC	9,525	12,7	12,7
T	4,76	4,76	6,35
ød	3,81	5,16	5,16
Holder	142	142	142

DESCRIPTION 형번		CARBIDE-CVD CVD코팅								CARBIDE-PVD PVD코팅						CERMET 세멧 (비코 팅, 코팅)	CARBIDE 조경						
		TC5110	TC5210	TC5120	TC5220	TC5230	TC4105	TC4115D	TC4215	TC4315	TC6125	TP0005P	TP0105P	TP0010P	TP0015P	TP0115P	TP0025	TP0005HP	TT5115	TTP5115	TU4005		
	DNMG150604-MS																						
	DNMG150608-MS																						
	DNMG150404-UF		●		●	●																	
	DNMG150408-UF		●		●	●																	
	DNMG150604-UF		●		●	●																	
	DNMG150608-UF		●		●	●																	
	DNMG150612-UF		●		●	●																	
	DNMG150404-UF1	●		●																			
	DNMG150408-UF1	●		●																			
	DNMG150604-UF1	●		●																			
	DNMG150608-UF1	●		●																			
	DNMG110404-UM		●		●	●																	
	DNMG110408-UM		●		●	●								●	●								
	DNMG150404-UM		●		●	●		●		●													
	DNMG150408-UM		●		●	●		●		●		●						●					
	DNMG150412-UM		●		●	●		●		●													
	DNMG150604-UM		●		●	●		●		●													
	DNMG150608-UM		●		●	●		●		●													
	DNMG150612-UM		●		●	●		●		●													
	DNMG110404-UM1	●						●															
	DNMG110408-UM1	●		●																			
	DNMG110412-UM1	●		●																			
	DNMG150404-UM1	●		●																			

finishing
 medium
 roughing

Vc ● fn ● ap 66

- TURNING
- GROOVING
- THREADING
- MILLING
- DRILLING
- ENDMILLS
- DRILLS
- SPARE PARTS
- INDEX

터닝

그루브

나사

면밀

인테셔널 드릴

엔드밀

솔리드 드릴

부품

색인표

**NEGATIVE
with hole**

DN □ □

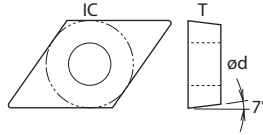

DN	1104	1504	1506
IC	9,525	12,7	12,7
T	4,76	4,76	6,35
Ød	3,81	5,16	5,16
Holder	142	142	142

DESCRIPTION 형번	CARBIDE-CVD CVD코팅								CARBIDE-PVD PVD코팅						CERMET 세멧 (비코팅, 코팅)		CARBIDE 초경				
	TC5110	TC5210	TC5120	TC5220	TC5230	TC4105	TC4115D	TC4215	TC4315	TC6125	TP0005P	TP0105P	TP0010P	TP0015P	TP0115P	TP0025	TP0005HP	TT5115	TTP5115	TU4005	
	DNMG150412-UM1		●																		
	DNMG150604-UM1	●	●																		
	DNMG150608-UM1	●	●																		
	DNMG150612-UM1		●																		
	DNMG150404-UMC	●	●	●	●																
	DNMG150408-UMC	●	●	●	●	●															
	DNMG150412-UMC		●		●	●															
	DNMG150604-UMC	●	●	●	●	●															
	DNMG150608-UMC		●		●	●															
	DNMG150612-UMC		●		●	●															
	DNMG150408-UR		●		●	●															
	DNMG150412-UR		●		●	●															
	DNMG150608-UR	●	●		●	●															
	DNMG150612-UR		●		●	●															
	DNMG150412-UR1		●																		
	DNMG150608-UR1	●	●				●						●								
	DNMG150612-UR1	●	●				●														
	DNMG150616-UR1	●	●				●														





TURNING 터닝

NEGATIVE
without hole

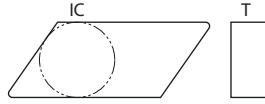
KN□□



KN	1604
IC	9,525
T	4,76
Holder	149

DESCRIPTION 형번	CARBIDE-CVD CVD코팅					CARBIDE-PVD PVD코팅						CERMET 세멧 (비코 팅,코팅)	CARBIDE 초경								
	TC5110	TC5210	TC5120	TC5220	TC5230	TC4105	TC4115D	TC4215	TC4315	TC6125	TP0005P	TP0105P	TP0010P	TP0015P	TP0115P	TP0025	TP0005HP	TT5115	TTP5115	TU4005	
 KNUX160405L11	●	●	●	●	●					●	●		●	●			●				
 KNUX160405R11	●	●	●	●	●					●	●		●	●			●				
KNUX160410L11	●	●	●	●	●					●	●		●	●			●				
KNUX160410R11	●	●	●	●	●					●	●		●	●			●				

 finishing
  medium
  roughing

Vc ● fn ● ap  66

- TURNING
- GROOVING
- THREADING
- MILLING
- DRILLING
- ENDMILLS
- DRILLS
- SPARE PARTS
- INDEX

터닝

그루브

나사

면밀

인테서블 드릴

엔드밀

슬리드 드릴

부품

색인표

POSITIVE 7°
with hole

RC□□

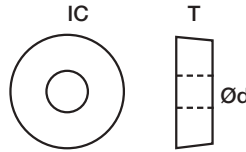

RC	0602	0803	10T3
IC	6,0	8,0	10,0
T	2,36	3,18	3,18
Ød	2,80	3,35	3,60
Holder	150	150	150

DESCRIPTION 형번	CARBIDE-CVD CVD코팅								CARBIDE-PVD PVD코팅						CERMET 세멧 (비코팅, 코팅)		CARBIDE 초경					
	TC5110	TC5210	TC5120	TC5220	TC5230	TC4105	TC4115D	TC4215	TC4315	TC6125	TP0005P	TP0105P	TP0010P	TP0015P	TP0115P	TP0025	TP0005HP	TT5115	TTP5115	TU4005		
 RCMX0803MO RCMX1003MO RCMX1204MO RCMX1606MO RCMX2006MO RCMX2507MO	●		●																			
	●		●																			
	●		●																			
	●		●																			
	●		●																			
	●		●																			
 RCGT0602MO-AUP RCGT0803MO-AUP RCGT1003MO-AUP RCGT10T3MO-AUP RCGT1204MO-AUP																					●	
																						●
																						●
																						●
																						●

finishing
 medium
 roughing

Vc ● fn ● ap

70

TURNING 터닝

POSITIVE 7°
with hole

SC □□

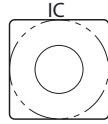

SC	09T3	1204
IC	9,525	12,7
T	3,97	4,76
Ød	4,40	5,16
Holder	154	154

DESCRIPTION 형번		CARBIDE-CVD CVD코팅					CARBIDE-PVD PVD코팅						CERMET 세멧 (비코 팅, 코팅)	CARBIDE 초경								
		TC5110	TC5210	TC5120	TC5220	TC5230	TC4105	TC4115D	TC4215	TC4315	TC6125	TP0005P	TP0105P	TP0010P	TP0015P	TP0115P	TP0025	TP0005HP	TT5115	TTP5115	TU4005	
	SCMT120404-UM		●		●	●																
	SCMT120408-UM		●		●	●																
	SCMT120408-UR				●	●																
	SCMT09T304-UR2			●				●														
	SCMT09T308-UR2	●		●				●														
	SCMT120404-UR2			●									●	●								
	SCMT120408-UR2	●		●				●														

finishing
 medium
 roughing

Vc ● fn ● ap 70

- TURNING
- GROOVING
- THREADING
- MILLING
- DRILLING
- ENDMILLS
- DRILLS
- SPARE PARTS
- INDEX

터닝

그루브

나사

면밀

인테서블 드릴

엔드밀

솔리드 드릴

부품



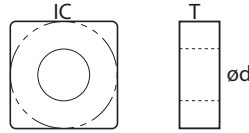

색인표

NEGATIVE
with hole

SN □□



SN	1204	1206	1506
IC	12,7	12,7	15,875
T	4,76	6,35	6,35
ød	5,16	5,16	6,35
Holder	156	156	156

DESCRIPTION 형번	CARBIDE-CVD CVD코팅				CARBIDE-PVD PVD코팅						CERMET 세멧 (비코팅, 코팅)		CARBIDE 초경									
	TC5110	TC5210	TC5120	TC5220	TC5230	TC4105	TC4115D	TC4215	TC4315	TC6125	TP0005P	TP0105P	TP0010P	TP0015P	TP0115P	TP0025	TP0005HP	TT5115	TTP5115	TU4005		
	SNMA120408					●	●	●	●													
	SNMA120412					●	●	●	●													
	SNMA120416					●	●	●	●													
	SNMA150608					●	●	●	●													
	SNMA150612					●	●	●	●													
	SNMA190608					●	●	●	●													
	SNMA190612					●	●	●	●													
	SNMG120404					●	●	●	●													
	SNMG120408					●	●	●	●													
	SNMG120412					●	●	●	●													
	SNMG120416					●	●	●	●													
	SNMG150608					●	●	●	●													
	SNMG150612					●	●	●	●													
	SNMG190608					●	●	●	●													
	SNMG120404					●	●	●	●													
	SNMG120408					●	●	●	●													
	SNMG120404-AU																				●	
	SNMG120408-AU																				●	
	SNMG120404-HA												●	●								

 finishing
  medium
  roughing

Vc ● fn ● ap
 
66

TURNING 터닝

NEGATIVE
with hole

SN □□

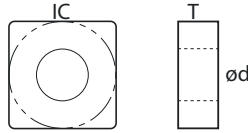

SN	1906	2507	2509
IC	19,05	25,4	25,4
T	6,35	7,94	9,52
ød	7,93	9,12	9,12
Holder	156	156	156

DESCRIPTION 형번	CARBIDE-CVD CVD코팅				CARBIDE-PVD PVD코팅						CERMET 세멧 (비코 팅, 코팅)		CARBIDE 초경								
	TC5110	TC5210	TC5120	TC5220	TC5230	TC4105	TC4115D	TC4215	TC4315	TC6125	TP0005P	TP0105P	TP0010P	TP0015P	TP0115P	TP0025	TP0005HP	TT5115	TTP5115	TU4005	
SNMG120408-MF																•					
SNMG120408-MF3											•		•		•						
SNMG120404-MM																•					
SNMG120408-MM																•					
SNMG120412-MM																•					
SNMG150608-MM																•					
SNMG150612-MM																•					
SNMG190608-MM																•					
SNMG190612-MM																•					
SNMG190616-MM																•					
SNMG120404-MM2											•			•							
SNMG120408-MM2											•	•	•	•	•		•				
SNMG120412-MM2													•	•	•						
SNMG150608-MM2														•							
SNMG120408-MR																•					
SNMG120412-MR																•					
SNMG150612-MR																•					
SNMG190612-MR																•					
SNMG190616-MR																•					

finishing
 medium
 roughing

Vc • fn • ap 66

TURNING
GROOVING
THREADING
MILLING
DRILLING
ENDMILLS
DRILLS
SPARE PARTS
INDEX

터닝

그루브

나사

면밀

인테셔널 드릴

엔드밀

슬리드 드릴

부품







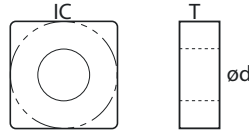

색인표

NEGATIVE
with hole

SN □□



SN	1204	1206	1506
IC	12,7	12,7	15,875
T	4,76	6,35	6,35
ød	5,16	5,16	6,35
Holder	156	156	156

DESCRIPTION 형번	CARBIDE-CVD CVD코팅								CARBIDE-PVD PVD코팅						CERMET 세멧 (비코팅, 코팅)		CARBIDE 초경					
	TC5110	TC5210	TC5120	TC5220	TC5230	TC4105	TC4115D	TC4215	TC4315	TC6125	TP0005P	TP0105P	TP0010P	TP0015P	TP0115P	TP0025	TP0005HP	TT5115	TTP5115	TU4005		
  SNMG120404-MS SNMG120408-MS																						
  SNMM150612-RB25 SNMM150616-RB25 SNMM190612-RB25 SNMM190616-RB25 SNMM190624-RB25 SNMM250724-RB25 SNMM250732-RB25 SNMM250924-RB25 SNMM250932-RB25																						
  SNMM150612-RH25 SNMM150616-RH25 SNMM190612-RH25 SNMM190616-RH25 SNMM190624-RH25 SNMM250724-RH25 SNMM250732-RH25 SNMM250924-RH25 SNMM250932-RH25																						
  SNMG120404-UF SNMG120408-UF SNMG120412-UF																						

 finishing
  medium
  roughing

Vc ● fn ● ap
 
66

TURNING 터닝

NEGATIVE
with hole

SN □□

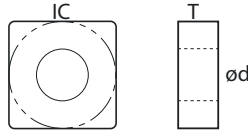

SN	1906	2507	2509
IC	19,05	25,4	25,4
T	6,35	7,94	9,52
ød	7,93	9,12	9,12
Holder	156	156	156

DESCRIPTION 형번		CARBIDE-CVD CVD코팅					CARBIDE-PVD PVD코팅							CERMET 세멧 (비코 팅, 코팅)	CARBIDE 초경									
		TC5110	TC5210	TC5120	TC5220	TC5230	TC4105	TC4115D	TC4215	TC4315	TC6125	TP0005P	TP0105P	TP0010P	TP0015P	TP0115P	TP0025	TP0005HIP	TT5115	TTP5115	TU4005			
		SNMG120408-UF1	•		•																			
		SNMG090304-UM		•		•	•																	
		SNMG120404-UM		•		•	•																	
		SNMG120408-UM		•		•	•																	
		SNMG120412-UM		•		•	•																	
		SNMG150608-UM		•		•	•																	
		SNMG150612-UM		•		•	•																	
		SNMG190608-UM		•		•	•																	
		SNMG190612-UM		•		•	•																	
		SNMG120404-UM1	•		•				•															
		SNMG120408-UM1	•		•				•						•				•					
		SNMG120412-UM1	•		•				•						•				•					
		SNMG150608-UM1	•		•																			
		SNMG150612-UM1	•		•																			
		SNMG190608-UM1	•		•																			
		SNMG190612-UM1			•											•								
		SNMG120408-UMC												•	•									
		SNMG120412-UMC		•		•	•								•	•								

finishing
 medium
 roughing

Vc • fn • ap 66

- TURNING
- GROOVING
- THREADING
- MILLING
- DRILLING
- ENDMILLS
- DRILLS
- SPARE PARTS
- INDEX

터닝

그루브

나사

면밀

인테서블 드릴

엔드밀

슬리드 드릴

부품



색인표

NEGATIVE
with hole

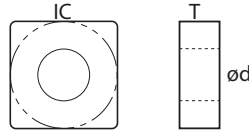
SN □□



SN	1204	1206	1506
IC	12,7	12,7	15,875
T	4,76	6,35	6,35
ød	5,16	5,16	6,35
Holder	156	156	156

DESCRIPTION 형번	CARBIDE-CVD CVD코팅				CARBIDE-PVD PVD코팅							CERMET 세멧 (비코팅, 코팅)		CARBIDE 초경							
	TC5110	TC5210	TC5120	TC5220	TC5230	TC4105	TC4115D	TC4215	TC4315	TC6125	TP0005P	TP0105P	TP0010P	TP0015P	TP0115P	TP0025	TP0005HP	TT5115	TTP5115	TU4005	
	SNMG120408-UR	●		●	●																
	SNMG120412-UR	●		●	●																
	SNMG150608-UR	●		●	●																
	SNMG150612-UR			●	●																
	SNMG190608-UR	●		●	●																
	SNMG190608-UR	●		●	●																
	SNMG190612-UR	●		●	●																
	SNMG190616-UR				●	●															
SNMG190624-UR				●	●																
	SNMG120408-UR1	●	●				●														
	SNMG120412-UR1	●	●				●														
	SNMG150612-UR1		●				●														
	SNMG190612-UR1	●	●				●						●								
	SNMG190616-UR1	●	●				●														
	SNMG190624-UR1		●																		

 finishing
  medium
  roughing

Vc ● fn ● ap
 
66

TURNING 터닝

POSITIVE 7°
with hole

TC □□



TC	0902	1102	16T3
IC	5,56	6,35	9,525
T	2,38	2,38	3,97
Ød	2,50	2,80	4,40
Holder	163	163	163

DESCRIPTION 형번	CARBIDE-CVD CVD코팅								CARBIDE-PVD PVD코팅						CERMET 세멧 (비코 팅, 코팅)	CARBIDE 초경							
	TC5110	TC5210	TC5120	TC5220	TC5230	TC4105	TC4115D	TC4215	TC4315	TC6125	TP0005P	TP0105P	TP0010P	TP0015P	TP0115P	TP0025	TP0005HP	TT5115	TTP5115	TU4005			
	TCGT090202-AU																					●	
	TCGT090204-AU																						●
	TCGT090208-AU																						●
	TCGT110202-AU																						●
	TCGT110204-AU																						●
	TCGT110208-AU																						●
	TCGT16T302-AU																						●
	TCGT16T304-AU																						●
TCGT16T308-AU																						●	
	TCMT16T304-GM													●								●	
	TCMT16T308-GM														●								●
	TCMT090204-MF1														●							●	
	TCMT110202-MF1			●											●								●
	TCMT110204-MF1	●		●								●	●	●	●								●
	TCMT16T304-MF1	●		●											●	●							●
	TCMT090204-MM1	●		●										●	●							●	
	TCMT090208-MM1	●		●										●	●								●
	TCMT110204-MM1	●		●				●						●	●								●
	TCMT110208-MM1	●		●									●	●	●								●
	TCMT16T304-MM1	●		●			●	●		●				●	●								●
	TCMT16T308-MM1	●		●				●						●	●								●

finishing
 medium
 roughing

Vc ● fn ● ap 70

- TURNING
- GROOVING
- THREADING
- MILLING
- DRILLING
- ENDMILLS
- DRILLS
- SPARE PARTS
- INDEX

터닝

그루브

나사

민공

인테서블 드릴

엔드밀

솔리드 드릴

부품

색인표

POSITIVE 7°
with hole

TC □□



TC	0902	1102	16T3
IC	5,56	6,35	9,525
T	2,38	2,38	3,97
ød	2,50	2,80	4,40
Holder	163	163	163

DESCRIPTION 형번	CARBIDE-CVD CVD코팅								CARBIDE-PVD PVD코팅						CERMET 세멧 (비코팅, 코팅)		CARBIDE 초경				
	TC5110	TC5210	TC5120	TC5220	TC5230	TC4105	TC4115D	TC4215	TC4315	TC6125	TP0005P	TP0105P	TP0010P	TP0015P	TP0115P	TP0025	TP0005HP	TT5115	TTP5115	TU4005	
	TCMT090204-MM5															●					
	TCMT110204-MM5															●					
	TCMT110208-MM5															●					
	TCMT16T304-MM5															●					
	TCMT16T308-MM5															●					
	TCMT16T312-MM5														●						
	TCMT090204-UF		●		●	●															
	TCMT110204-UF		●		●	●															
	TCMT110208-UF		●		●	●															
	TCMT16T304-UF		●		●	●															
	TCMT16T308-UF		●		●	●															
	TCMT090204-UM		●		●	●															
	TCMT090208-UM		●		●	●															
	TCMT110204-UM		●		●	●															
	TCMT110208-UM		●		●	●															
	TCMT110304-UM		●		●	●															
	TCMT110308-UM		●		●	●															
	TCMT16T304-UM		●		●	●															
	TCMT16T308-UM		●		●	●															
TCMT16T312-UM		●		●	●																
TCMT220408-UM				●	●																

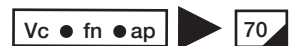

TURNING 터닝

POSITIVE 7°
with hole

TC □□

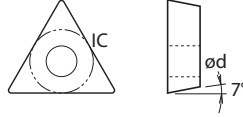

TC	0902	1102	16T3
IC	5,56	6,35	9,525
T	2,38	2,38	3,97
ød	2,50	2,80	4,40
Holder	163	163	163

DESCRIPTION 형번		CARBIDE-CVD CVD코팅								CARBIDE-PVD PVD코팅						CERMET 세멧 (비코 팅, 코팅)	CARBIDE 조경						
		TC5110	TC5210	TC5120	TC5220	TC5230	TC4105	TC4115D	TC4215	TC4315	TC6125	TP0005P	TP0105P	TP0010P	TP0015P	TP0115P	TP0025	TP0005HP	TT5115	TTP5115	TU4005		
		TCMT110204-UM2	●		●										●	●		●					
		TCMT110208-UM2	●		●											●	●		●				
		TCMT16T304-UM2	●		●											●	●						
		TCMT16T308-UM2	●		●																		
		TCMT16T308-UR			●	●																	
		TCMT16T308-UR2		●											●	●							

finishing
 medium
 roughing

Vc ● fn ● ap 70

- TURNING
- GROOVING
- THREADING
- MILLING
- DRILLING
- ENDMILLS
- DRILLS
- SPARE PARTS
- INDEX

터닝

그루브

나사

면밀

인테서블 드릴

엔드밀

슬리드 드릴

부품

색인표

**NEGATIVE
with hole**

TN □□



TN	1604	2204	2706
IC	9,525	12,7	15,875
T	4,76	4,76	6,35
ød	3,81	5,16	6,35
Holder	170	170	170

DESCRIPTION 형번	CARBIDE-CVD CVD코팅				CARBIDE-PVD PVD코팅						CERMET 세멧 (비코팅, 코팅)		CARBIDE 초경											
	TC5110	TC5210	TC5120	TC5220	TC5230	TC4105	TC4115D	TC4215	TC4315	TC6125	TP0005P	TP0105P	TP0010P	TP0015P	TP0115P	TP0025	TP0005HP	TT5115	TTP5115	TU4005				
	TNMA160408					●	●	●	●															
	TNMA160412					●	●	●	●															
	TNMA160416					●	●	●	●															
	TNMA220408					●	●	●	●															
	TNMA220412					●	●	●	●															
	TNMG160404					●	●	●	●															
	TNMG160408					●	●	●	●															
	TNMG160412					●	●	●	●															
	TNMG160416					●	●	●	●															
	TNMG220408					●	●	●	●															
	TNMG160404L	●	●	●	●	●							●	●	●	●	●							
	TNMG160404R	●	●	●	●	●							●	●	●	●	●							
	TNMG160408L	●	●	●	●	●							●	●	●	●	●							
	TNMG160408R	●	●	●	●	●							●	●	●	●	●							
	TNMG160404L-A3				●	●								●	●		●							
	TNMG160404R-A3				●	●								●	●		●							
	TNMG160408L-A3				●	●								●	●		●							
	TNMG160408R-A3				●	●								●	●		●							
	TNMG160404-AU																					●		
	TNMG160408-AU																					●		
	TNMG220404-AU																						●	
	TNMG220408-AU																						●	
	TNMG220404-AU																							●

finishing
 medium
 roughing

Vc ● fn ● ap 66

TURNING 터닝

NEGATIVE
with hole

TN □□

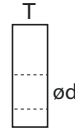

TN	1604	2204	2706
IC	9,525	12,7	15,875
T	4,76	4,76	6,35
ød	3,81	5,16	6,35
Holder	170	170	170

DESCRIPTION 형번		CARBIDE-CVD CVD코팅								CARBIDE-PVD PVD코팅						CERMET 세멧 (비코 팅, 코팅)	CARBIDE 초경					
		TC5110	TC5210	TC5120	TC5220	TC5230	TC4105	TC4115D	TC4215	TC4315	TC6125	TP0005P	TP0105P	TP0010P	TP0015P	TP0115P	TP0025	TP0005HP	TT5115	TTP5115	TU4005	
		TNMG160408-GH						•	•													
		TNMG220412-GH						•	•													
		TNMG220416-GH						•	•	•												
		TNMG160404-MF														•						
		TNMG160408-MF														•						
		TNMG160404-MF2	•		•								•	•	•		•					
		TNMG160408-MF2												•								
		TNMG160408-MF3	•		•						•			•	•							
		TNMG160412-MF3												•								
		TNMG160404-MF4												•	•		•					
		TNMG160404-MM	•	•	•	•	•				•			•	•	•	•					
		TNMG160408-MM	•	•	•	•	•						•	•	•	•	•					
		TNMG160412-MM		•		•	•										•					
		TNMG160416-MM															•					
		TNMG220404-MM															•					
		TNMG220408-MM															•					
		TNMG220412-MM															•					

finishing
 medium
 roughing

Vc • fn • ap
 66

- TURNING
- GROOVING
- THREADING
- MILLING
- DRILLING
- ENDMILLS
- DRILLS
- SPARE PARTS
- INDEX

터닝

그루비

나사

면역

인테셔널 드릴

엔드밀

솔리드 드릴

부품

색인표

NEGATIVE
with hole

TN □□

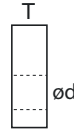

TN	1604	2204	2706
IC	9,525	12,7	15,875
T	4,76	4,76	6,35
Ød	3,81	5,16	6,35
Holder	170	170	170

DESCRIPTION 형번	CARBIDE-CVD CVD코팅								CARBIDE-PVD PVD코팅						CERMET 세멧 (비코 팅, 코팅)		CARBIDE 초경				
	TC5110	TC5210	TC5120	TC5220	TC5230	TC4105	TC4115D	TC4215	TC4315	TC6125	TP0005P	TP0105P	TP0010P	TP0015P	TP0115P	TP0025	TP0005HP	TT5115	TTP5115	TU4005	
	TNMG160404-MM2	●		●													●				
	TNMG160408-MM2	●		●													●				
	TNMG220404-MM2												●	●	●		●				
	TNMG220408-MM2			●										●	●						
	TNMG160412-MR															●					
	TNMG220412-MR															●					
	TNMG160404-MS										●	●	●	●							
	TNMG160408-MS										●	●	●	●	●						
	TNMG160404-TQ	●												●	●						
	TNMG160408-TQ			●										●	●						
	TNMG160404-UF		●		●	●															
	TNMG160408-UF		●		●	●															
	TNMG160412-UF		●		●	●															
	TNMG220404-UF		●		●	●															
	TNMG220408-UF		●		●	●															
	TNMG160404-UF1	●		●									●	●			●				
	TNMG160408-UF1			●									●	●							

finishing
 medium
 roughing

Vc ● fn ● ap 66

TURNING 터닝

NEGATIVE
with hole

TN □□

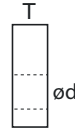

TN	1604	2204	2706
IC	9,525	12,7	15,875
T	4,76	4,76	6,35
ød	3,81	5,16	6,35
Holder	170	170	170

DESCRIPTION 형번		CARBIDE-CVD CVD코팅					CARBIDE-PVD PVD코팅							CERMET 세멧 (비코 팅, 코팅)	CARBIDE 조경									
		TC5110	TC5210	TC5120	TC5220	TC5230	TC4105	TC4115D	TC4215	TC4315	TC6125	TP0005P	TP0105P	TP0010P	TP0015P	TP0115P	TP0025	TP0005HP	TT5115	TTP5115	TU4005			
	TNMG160404-UM		●		●	●																		
	TNMG160408-UM		●		●	●																		
	TNMG160412-UM		●		●	●																		
	TNMG220404-UM		●		●	●																		
	TNMG220408-UM		●		●	●																		
	TNMG220412-UM		●		●	●																		
	TNMG160404-UM1	●		●								●		●		●								
	TNMG160408-UM1	●		●				●						●		●								
	TNMG160412-UM1	●		●										●		●								
	TNMG160416-UM1	●		●											●									
	TNMG220404-UM1	●		●											●									
	TNMG220408-UM1	●		●					●						●									
TNMG220412-UM1			●																					
	TNMG160404-UMC	●	●	●	●	●		●	●															
	TNMG160408-UMC	●	●	●	●	●		●	●															
	TNMG160412-UMC	●	●	●	●	●		●	●															
	TNMG220404-UMC		●		●	●																		
	TNMG220408-UMC		●		●	●																		
	TNMG220412-UMC		●		●	●																		

finishing
 medium
 roughing

Vc ● fn ● ap 66

TURNING
GROOVING
THREADING
MILLING
DRILLING
ENDMILLS
DRILLS
SPARE PARTS
INDEX

터닝

그루브

나사

면밀

인테서블 드릴

엔드밀

솔리드 드릴

부품

색인표

NEGATIVE
with hole

TN

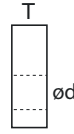

TN	1604	2204	2706
IC	9,525	12,7	15,875
T	4,76	4,76	6,35
Ød	3,81	5,16	6,35
Holder			

DESCRIPTION 형번	CARBIDE-CVD CVD코팅								CARBIDE-PVD PVD코팅						CERMET 세멧 (비코 팅, 코팅)		CARBIDE 초경					
	TC5110	TC5210	TC5120	TC5220	TC5230	TC4105	TC4115D	TC4215	TC4315	TC6125	TP0005P	TP0105P	TP0010P	TP0015P	TP0115P	TP0025	TP0005HP	TT5115	TTP5115	TU4005		
 	TNMG160408-UR	•		•	•																	
	TNMG160412-UR	•		•	•																	
	TNMG220408-UR		•		•	•																
	TNMG220412-UR		•		•	•																
 	TNMG160408-UR1	•		•			•															
	TNMG160412-UR1	•		•			•															
	TNMG220412-UR1	•		•			•															
	TNMG220416-UR1			•			•						•	•								

finishing
 medium
 roughing

Vc • fn • ap 66

TURNING 터닝

POSITIVE 11°
with hole

TP □□

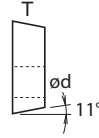

TP	0802	0902	1103
IC	4,76	5,56	6,35
T	2,38	2,38	3,18
ød	2,30	3,00	3,40
Holder	169	169	169

DESCRIPTION 형번		CARBIDE-CVD CVD코팅								CARBIDE-PVD PVD코팅						CERMET 세멧 (비코 팅, 코팅)	CARBIDE 조경					
		TC5110	TC5210	TC5120	TC5220	TC5230	TC4105	TC4115D	TC4215	TC4315	TC6125	TP0005P	TP0105P	TP0010P	TP0015P	TP0115P	TP0025	TP0005HP	TT5115	TTP5115	TU4005	
	TPMR160304	●		●																		
	TPMR160308	●		●																		
	TPMT110304-TQ			●									●	●								
	TPUN160304																●					
	TPUN160308													●			●					
	TPUN220408																●					
	TPUN220412																●					

finishing
 medium
 roughing

Vc ● fn ● ap 70

- TURNING
- GROOVING
- THREADING
- MILLING
- DRILLING
- ENDMILLS
- DRILLS
- SPARE PARTS
- INDEX

터닝

그루브

나사

면임

인테서블 드릴

엔드밀

솔리드 드릴

부품

색인표

**POSITIVE 5°
with hole**

VB □□

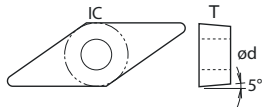

VB	1103	1604
IC	6,35	9,525
T	3,18	4,76
Ød	2,80	4,40
Holder	175	175

DESCRIPTION 형번		CARBIDE-CVD CVD코팅								CARBIDE-PVD PVD코팅						CERMET 세멧 (비코팅, 코팅)		CARBIDE 초경						
		TC5110	TC5210	TC5120	TC5220	TC5230	TC4105	TC4115D	TC4215	TC4315	TC6125	TP0005P	TP0105P	TP0010P	TP0015P	TP0115P	TP0025	TP0005HP	TT5115	TTP5115	TU4005			
	VBGT110302-AU																						●	
	VBGT110304-AU																							●
	VBGT160402-AU																							●
	VBGT160404-AU																							●
	VBGT160408-AU																							●
	VBGT160412-AU																							●
	VBMT160404																●							●
	VBMT160408																●							●
	VBMT160404-GM															●	●							●
																								●
	VBMT110302-MF																●							●
	VBMT160404-MF																●							●
	VBMT160408-MF																●							●
	VBMT110304-MM																●							●
																								●
	VBMT110304-MM1																●							●
	VBMT160404-MM1	●		●													●	●						●
	VBMT160408-MM1	●		●				●									●	●						●
	VBMT160412-MM1																●	●						●

finishing medium roughing

Vc ● fn ● ap 70

TURNING 터닝

POSITIVE 5°
with hole

VB □□

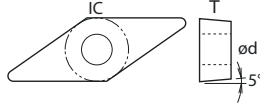

VB	1103	1604
IC	6,35	9,525
T	3,18	4,76
Ød	2,80	4,40
Holder	175	175

DESCRIPTION 형번		CARBIDE-CVD CVD코팅								CARBIDE-PVD PVD코팅					CERMET 세멧 (비코 팅, 코팅)	CARBIDE 조경							
		TC5110	TC5210	TC5120	TC5220	TC5230	TC4105	TC4115D	TC4215	TC4315	TC6125	TP0005P	TP0105P	TP0010P	TP0015P	TP0115P	TP0025	TP0005HP	TT5115	TTP5115	TU4005		
	VBMT160404-MM3																						
		VBMT160404-MM4																					
	VBMT110302-UF		●		●	●																	
	VBMT160402-UF		●		●	●																	
	VBMT160404-UF		●		●	●																	
	VBMT160408-UF		●		●	●																	
	VBMT110304-UM		●		●	●																	
	VBMT160404-UM		●		●	●																	
	VBMT160408-UM		●		●	●																	
	VBMT160412-UM		●		●	●																	
	VBMT160408-UR				●	●																	
	VBMT160412-UR				●	●																	
	VBMT160408-UR2							●							●								
	VBMT160412-UR2							●							●								

finishing
 medium
 roughing

Vc ● fn ● ap 70

- TURNING
- GROOVING
- THREADING
- MILLING
- DRILLING
- ENDMILLS
- DRILLS
- SPARE PARTS
- INDEX

터닝

그루브

나사

민공

인테서블 드릴

엔드밀

솔리드 드릴

부품

색인표

POSITIVE 7°
with hole

VC □□

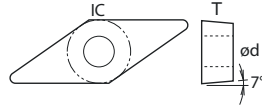

VC	1103	1604	2205
IC	6,35	9,525	12,70
T	3,18	4,76	5,56
Ød	2,80	4,40	5,60
Holder	181	181	181

DESCRIPTION 형번	CARBIDE-CVD CVD코팅								CARBIDE-PVD PVD코팅						CERMET 세멧 (비코팅, 코팅)		CARBIDE 초경						
	TC5110	TC5210	TC5120	TC5220	TC5230	TC4105	TC4115D	TC4215	TC4315	TC6125	TP0005P	TP0105P	TP0010P	TP0015P	TP0115P	TP0025	TP0005HP	TT5115	TTP5115	TJ4005			
	VCGT110302-AU																					●	
	VCGT110304-AU																						●
	VCGT160402-AU																						●
	VCGT160404-AU																						●
	VCGT160408-AU																						●
	VCGT160412-AU																						●
	VCGT220516-AU2C																					●	
	VCGT110302-AUP																					●	
	VCGT110304-AUP																					●	
	VCGT220530E-AUP																						●
	VCMT110302-MF1													●									
	VCMT110304-MF1		●											●									
	VCMT160402-MF1				●									●									
	VCMT160404-MF1		●		●									●									
	VCMT160408-MF1				●									●									
	VCMT110304-MM1				●								●										
	VCMT160404-MM1		●		●								●	●									
	VCMT160408-MM1		●		●								●	●									

finishing
 medium
 roughing
 Vc ● fn ● ap
 ▶ 70

TURNING 터닝

POSITIVE 7°
with hole

VC □□

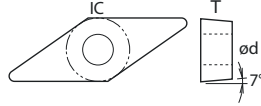

VC	1103	1604	2205
IC	6,35	9,525	12,70
T	3,18	4,76	5,56
Ød	2,80	4,40	5,60
Holder	181	181	181

DESCRIPTION 형번	CARBIDE-CVD CVD코팅								CARBIDE-PVD PVD코팅						CERMET 세멧 (비코 팅, 코팅)		CARBIDE 초경					
	TC5110	TC5210	TC5120	TC5220	TC5230	TC4105	TC4115D	TC4215	TC4315	TC6125	TP0005P	TP0105P	TP0010P	TP0015P	TP0115P	TP0025	TP0005HP	TT5115	TTP5115	TU4005		
VCGX110302-SF-OK											●											
	VCGX110304-SF-OK										●											
	VCMT110302-UF	●		●	●																	
	VCMT110304-UF	●		●	●																	
	VCMT110308-UF	●		●	●																	
	VCMT160402-UF	●		●	●																	
	VCMT160404-UF	●		●	●																	
	VCMT160408-UF	●		●	●																	
	VCMT110304-UM	●		●	●																	
	VCMT110308-UM	●		●	●																	
	VCMT160404-UM	●		●	●																	
	VCMT160408-UM	●		●	●																	
	VCMT110308-UR			●	●																	
	VCMT160408-UR			●	●																	
	VCMT160412-UR			●	●																	

finishing
 medium
 roughing

Vc ● fn ● ap 70

- TURNING
- GROOVING
- THREADING
- MILLING
- DRILLING
- ENDMILLS
- DRILLS
- SPARE PARTS
- INDEX

터닝

그루브

나사

밀링

인테서블 드릴

엔드밀

솔리드 드릴

부품

색인표

**NEGATIVE
with hole**

VN □□

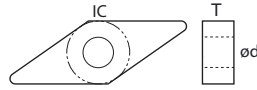

VN	1604
IC	9,525
T	4,76
ød	3,81
Holder	183

DESCRIPTION 형번	CARBIDE-CVD CVD코팅								CARBIDE-PVD PVD코팅						CERMET 세멧 (비코 팅, 코팅)		CARBIDE 초경				
	TC5110	TC5210	TC5120	TC5220	TC5230	TC4105	TC4115D	TC4215	TC4315	TC6125	TP0005P	TP0105P	TP0010P	TP0015P	TP0115P	TP0025	TP0005HP	TT5115	TTP5115	TU4005	
	VNMG160404																●				
	VNMG160408																●				
	VNMG160412																●				
	VNMG160404-AU																				●
	VNMG160408-AU																				
	VNMG160404-MF																●				
	VNMG160408-MF																●				
	VNMG160404-MF2										●			●	●						
	VNMG160408-MF3																●	●			
	VNMG160404-MM	●	●	●	●	●		●				●		●	●	●	●				

finishing
 medium
 roughing

Vc ● fn ● ap 66

TURNING 터닝

NEGATIVE
with hole

VN □□

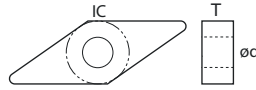

VN	1604
IC	9,525
T	4,76
ød	3,81
Holder	183

DESCRIPTION 형번	CARBIDE-CVD CVD코팅								CARBIDE-PVD PVD코팅						CERMET 세멧 (비코 팅,코팅)	CARBIDE 조경					
	TC5110	TC5210	TC5120	TC5220	TC5230	TC4105	TC4115D	TC4215	TC4315	TC6125	TP0005P	TP0105P	TP0010P	TP0015P	TP0115P	TP0025	TP0005HP	TT5115	TTP5115	TU4005	
	VNMG160408-MM	●		●	●											●					
	VNMG160412-MM	●		●	●											●					
	VNMG160404-MM2	●		●									●	●	●						
	VNMG160408-MM2	●		●									●	●	●						
	VNMG160404-MS													●							
	VNMG160408-MS													●	●						
	VNMG160404-UF	●		●	●																
	VNMG160408-UF	●		●	●																
	VNMG160404-UM	●		●	●																
	VNMG160408-UM	●		●	●																
	VNMG160412-UM	●		●	●																
	VNMG160404-UM1	●	●				●							●	●						
	VNMG160408-UM1	●	●									●	●				●				
	VNMG160412-UM1		●				●					●									

finishing
 medium
 roughing

Vc ● fn ● ap 66

- TURNING
- GROOVING
- THREADING
- MILLING
- DRILLING
- ENDMILLS
- DRILLS
- SPARE PARTS
- INDEX

터닝

그루브

나사

면밀

인테서블 드릴

엔드밀

솔리드 드릴

부품







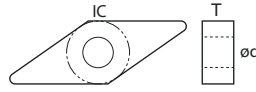

색인표

**NEGATIVE
with hole**

VN □□



VN	1604
IC	9,525
T	4,76
ød	3,81
Holder	183

DESCRIPTION 형번	CARBIDE-CVD CVD코팅					CARBIDE-PVD PVD코팅							CERMET 세멧 (비코 팅,코팅)	CARBIDE 초경							
	TC5110	TC5210	TC5120	TC5220	TC5230	TC4105	TC4115D	TC4215	TC4315	TC6125	TP0005P	TP0105P	TP0010P	TP0015P	TP0115P	TP0025	TP0005HP	TT5115	TTP5115	TU4005	
  VNMG160404-UMC	●	●	●	●	●																
  VNMG160408-UMC	●	●	●	●	●																
  VNMG160412-UMC		●		●	●																
  VNMG160412-UR1	●		●				●	●													

 finishing
  medium
  roughing

Vc ● fn ● ap  66

TURNING 터닝

NEGATIVE
with hole

WN□□

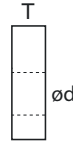

WN	0604	0804
IC	9,525	12,7
T	4,76	4,76
ød	3,81	5,16
Holder	186	186

DESCRIPTION 형번	CARBIDE-CVD CVD코팅								CARBIDE-PVD PVD코팅						CERMET 세멧 (비코 팅,코팅)	CARBIDE 조경					
	TC5110	TC5210	TC5120	TC5220	TC5230	TC4105	TC4115D	TC4215	TC4315	TC6125	TP0005P	TP0105P	TP0010P	TP0015P	TP0115P	TP0025	TP0005HP	TT5115	TTP5115	TU4005	
	WNMA080408					●	●	●	●												
	WNMA080412					●	●	●	●												
	WNMA080416					●	●	●	●												
	WNMG080404					●	●	●	●												
	WNMG080408					●	●	●	●												
	WNMG080412					●	●	●	●												
	WNMG080404-AU																				●
	WNMG080408-AU																				●
	WNMG080408-GH					●	●	●	●												
	WNMG080412-GH					●	●	●	●												
	WNMG080404-MF															●					
	WNMG080408-MF															●					
	WNMG080404-MF2												●	●							
	WNMG060408-MF3	●												●							
	WNMG080408-MF3									●				●	●		●				
	WNMG080412-MF3													●	●						

finishing
 medium
 roughing

Vc ● fn ● ap 66

TURNING
GROOVING
THREADING
MILLING
DRILLING
ENDMILLS
DRILLS
SPARE PARTS
INDEX

터닝

그루비

나사

면밀

인테서블 드릴

엔드밀

슬리드 드릴

부품

색인표

**NEGATIVE
with hole**

WN □ □

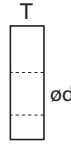
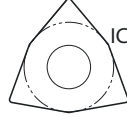

WN	0604	0804
IC	9,525	12,7
T	4,76	4,76
Ød	3,81	5,16
Holder	186	186

DESCRIPTION 형번	CARBIDE-CVD CVD코팅								CARBIDE-PVD PVD코팅						CERMET 세멧 (비코팅, 코팅)		CARBIDE 조경										
	TC5110	TC5210	TC5120	TC5220	TC5230	TC4105	TC4115D	TC4215	TC4315	TC6125	TP0005P	TP0105P	TP0010P	TP0015P	TP0115P	TP0025	TP0005HP	TT5115	TTP5115	TU4005							
	WNMG060408-MF4																										
	WNMG080404-MF4																										
	WNMG080408-MF4																										
	WNMG060404-MM																										
	WNMG060408-MM																										
	WNMG080404-MM	●	●	●	●	●																					
	WNMG080408-MM	●	●	●	●	●																					
	WNMG080412-MM		●			●	●																				
	WNMG060408-MM2																										
	WNMG060412-MM2																										
	WNMG080404-MM2	●		●																							
	WNMG080408-MM2	●		●						●																	
	WNMG080404-MM3																										
	WNMG080408-MM3																										
	WNMG080412-MR																										
	WNMG080404-MS																										
	WNMG080408-MS																										
	WNMG080412-MS																										



TURNING 터닝

NEGATIVE
with hole

WN



WN	0604	0804
IC	9,525	12,7
T	4,76	4,76
ød	3,81	5,16
Holder		

DESCRIPTION 형번	CARBIDE-CVD CVD코팅								CARBIDE-PVD PVD코팅						CERMET 세멧 (비코 팅,코팅)		CARBIDE 조경					
	TC5110	TC5210	TC5120	TC5220	TC5230	TC4105	TC4115D	TC4215	TC4315	TC6125	TP0005P	TP0105P	TP0010P	TP0015P	TP0115P	TP0025	TP0005HP	TT5115	TTP5115	TJ4005		
	WNMG080404-TQ	●		●																		
													●	●								
	WNMG060404-UF		●		●	●																
	WNMG060408-UF		●		●	●																
	WNMG080404-UF		●		●	●																
	WNMG080408-UF		●		●	●																
	WNMG080412-UF		●		●	●																
	WNMG060404-UF1			●																		
	WNMG080404-UF1	●		●								●	●				●					
	WNMG080408-UF1	●		●																		
	WNMG060404-UM		●		●	●																
	WNMG060408-UM		●		●	●																
	WNMG060412-UM		●		●	●																
	WNMG080404-UM		●		●	●																
	WNMG080408-UM		●		●	●																
	WNMG080412-UM		●		●	●																
	WNMG060408-UM1	●		●																		
	WNMG080404-UM1	●		●			●						●	●								
	WNMG080408-UM1	●		●			●				●	●	●	●	●		●					
	WNMG080412-UM1	●		●			●						●	●								
	WNMG080404-UMC	●	●	●	●	●																
	WNMG080408-UMC	●	●	●	●	●																
	WNMG080412-UMC	●	●	●	●	●																

finishing
 medium
 roughing

Vc ● fn ● ap 66

- TURNING
- GROOVING
- THREADING
- MILLING
- DRILLING
- ENDMILLS
- DRILLS
- SPARE PARTS
- INDEX

터닝

그루비

나사

밀링

인테셔널 드릴

엔드밀

솔리드 드릴

부품

색인표

**NEGATIVE
with hole**

WN □ □

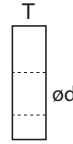
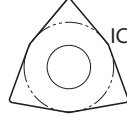

WN	0604	0804
IC	9,525	12,7
T	4,76	4,76
Ød	3,81	5,16
Holder	186	186

DESCRIPTION 형번		CARBIDE-CVD CVD코팅				CARBIDE-PVD PVD코팅						CERMET 세멧 (비코팅, 코팅)		CARBIDE 조경										
		TC5110	TC5210	TC5120	TC5220	TC5230	TC4105	TC4115D	TC4215	TC4315	TC6125	TP0005P	TP0105P	TP0010P	TP0015P	TP0115P	TP0025	TP0005HP	TT5115	TTP5115	TU4005			
		WNMG060408-UR	●		●	●																		
		WNMG060412-UR	●		●	●																		
		WNMG080408-UR	●		●	●																		
		WNMG080412-UR	●		●	●																		
		WNMG080408-UR1	●		●	●	●	●						●										
		WNMG080412-UR1	●		●	●			●	●					●									
		WNMG080408-Z						●	●															
		WNMG080412-Z							●	●														

finishing
 medium
 roughing

Vc ● fn ● ap

66

TURNING 터닝

Cutting Parameters Vc(m/min) / 절삭 조건 (속력)

FC	회주철 GRAY CAST IRON
FCD	덕타일 DUCTILE CAST IRON
S15C	저탄소강 LOW CARBON AND FREE
S30C	탄소강 MEDIUM CARBON
S45C	고탄소강 HIGH CARBON STEEL
SCM	합금강 ALLOY STEEL

SUS400	마르텐사이트 MARTENSITIC AND FERRITIC STAINLESS STEEL
SUS300	오스테나이트 AUSTENITIC STAINLESS STEEL
AL	알루미늄합금 ALUMINIUM ALLOYS
HAL	강화알루미늄합금 ALUMINIUM ALLOYS AGED AND HARDENED
NB	황동 BRASS
CU	청동, 구리 BRONZE AND ELECTROLYTIC COPPER

MATERIAL 피삭재		CARBIDE-CVD / CVD 재종								
		TC5210 TC5110	TC5220 TC5120	TC5230 TC5130	TC5240	TC4105	TC4115D	TC4215	TC4315	TC6125
K	FC					250~450	200~360	200~360	200~360	
	FCD					180~300	150~280	150~280	150~280	
P	S15C	250~350	200~320	200~320	200~320					
	S30C	220~300	180~260	180~260	180~260					
	S45C	200~280	160~250	160~250	160~250					
	SCM	180~250	150~220	150~220	150~220					
M	SUS400									160~260
	SUS300									140~220

MATERIAL 피삭재		CARBIDE-PVD / PVD 재종				CERMET 써메트	CARBIDE 재종	
		TP0005P TP0005HP TP0105P	TP0105P	TP0015P TP0115P	TP0025		TT5115 TTP5115	TU4005 TU4005P
K	FC					250~400		
	FCD					180~300		
P	S15C					280~380		
	S30C					240~330		
	S45C					220~300		
	SCM					200~280		
M	SUS400	120~220	100~150	100~150	100~150	180~250		
	SUS300	100~180	80~120	80~120	80~120	160~220		
N	AL						600~1500	
	HAL						300~700	
	NB						250~400	
	CU						150~250	

- TURNING
- GROOVING
- THREADING
- MILLING
- DRILLING
- ENDMILLS
- DRILLS
- SPARE PARTS
- INDEX

negative / 네가티브



Cutting Parameters a_p (mm) & f_n (mm/rev) / 절삭 조건 (절입량 & 피드)

NEGATIVE INSERT SIZE		CN	-	1204..	1606..	1906..	2507.. 2509..
		DN	1104..	1504.. 1506..	-	-	-
		SN	0903..	1204..	-	1906..	2507.. 2509..
		TN	-	1604..	2204..	-	-
		VN	-	1604..	-	-	-
		WN	0604..	0804..	-	-	-

Chip Breaker Form	Corner Radius	a_p (mm)	f_n (mm/rev)	a_p (mm)	f_n (mm/rev)	a_p (mm)	f_n (mm/rev)	a_p (mm)	f_n (mm/rev)	a_p (mm)	f_n (mm/rev)
MA FLAT	R02										
	R04	0.5-2.5	0.1-0.3	1.0-4.0	0.1-0.5	2.0-6.0	0.15-0.7	2.0-7.0	0.15-0.7		
	R08	0.5-3.0	0.1-0.35	1.5-5.0	0.15-0.6	2.0-7.0	0.2-0.75	2.0-7.0	0.2-0.75		
	R12	0.5-3.5	0.1-0.4	1.5-5.0	0.15-0.6	2.0-7.0	0.2-0.75	2.0-7.0	0.2-0.75	8.00-16.0	0.45-1.00
	R16 / R24									8.00-18.0	0.50-1.10
MG BOX	R02										
	R04	0.5-2.5	0.1-0.3	1.0-4.0	0.1-0.5	2.0-6.0	0.15-0.7	2.0-7.0	0.15-0.7	8.00-16.0	0.45-0.89
	R08	0.5-3.0	0.1-0.35	1.5-5.0	0.15-0.6	2.0-7.0	0.2-0.75	2.0-7.0	0.2-0.75		
	R12	0.5-3.5	0.1-0.4	1.5-5.0	0.15-0.6	2.0-7.0	0.2-0.75	2.0-7.0	0.2-0.75		
	R16 / R24									8.00-18.0	0.50-1.10
A3	R02										
	R04			0.8-3.5	0.1-0.4						
	R08			0.8-3.5	0.1-0.4						
	R12										
	R16 / R24										
AU	R02										
	R04			0.5-4.0	0.1-0.35						
	R08			0.5-4.0	0.1-0.35						
	R12										
	R16 / R24										
HA	R02										
	R04			0.5-2.0	0.05-0.25						
	R08			0.5-3.5	0.1-0.35						
	R12										
	R16 / R24										
GH	R02										
	R04										
	R08			1.5-5.0	0.2-0.5						
	R12			2.0-5.0	0.2-0.5	2.0-8.0	0.3-0.6				
	R16 / R24					2.0-10.0	0.3-0.7			1.80-10.00	0.30-0.80
MF	R02										
	R04	0.3-1.5	0.1-0.3	0.5-2.0	0.1-0.4						
	R08	0.5-2.0	0.1-0.35	0.5-3.0	0.15-0.45						
	R12	0.5-2.5	0.1-0.4	1.0-3.5	0.15-0.45						
	R16 / R24										

negative / 네가티브



Cutting Parameters a_p (mm) & f_n (mm/rev) / 절삭 조건 (절입량 & 피드)

NEGATIVE INSERT SIZE		CN	-	1204..	1606..	1906..	2507.. 2509..
		DN	1104..	1504.. 1506..	-	-	-
		SN	0903..	1204..	-	1906..	2507.. 2509..
		TN	-	1604..	2204..	-	-
		VN	-	1604..	-	-	-
		WN	0604..	0804..	-	-	-

Chip Breaker Form	Corner Radius	a_p (mm)	f_n (mm/rev)	a_p (mm)	f_n (mm/rev)	a_p (mm)	f_n (mm/rev)	a_p (mm)	f_n (mm/rev)	a_p (mm)	f_n (mm/rev)
MF2	R02										
	R04	0.3-1.5	0.1-0.3	0.5-2.0	0.1-0.4						
	R08	0.5-2.0	0.1-0.35	0.5-3.0	0.15-0.45						
	R12	0.5-2.5	0.1-0.4	1.0-3.5	0.15-0.45					8.00-16.0	0.45-1.00
	R16 / R24									8.00-18.0	0.50-1.10
MF3	R02										
	R04			0.5-2.0	0.1-0.4					8.00-16.0	0.45-0.89
	R08			0.5-3.0	0.15-0.45						
	R12			1.0-3.5	0.15-0.45						
	R16 / R24									8.00-18.0	0.50-1.10
MF4	R02										
	R04	0.3-1.5	0.1-0.3	0.5-2.0	0.1-0.4						
	R08	0.5-2.0	0.1-0.35	0.5-3.0	0.15-0.45						
	R12	0.5-2.5	0.1-0.4	1.0-3.5	0.15-0.45						
	R16 / R24										
MM	R02										
	R04	0.5-2.5	0.1-0.3	1.0-4.0	0.1-0.5	2.0-6.0	0.15-0.7	2.0-7.0	0.15-0.7		
	R08	0.5-3.0	0.1-0.35	1.5-5.0	0.15-0.6	2.0-7.0	0.2-0.75	2.0-7.0	0.2-0.75		
	R12	0.5-3.5	0.1-0.4	1.5-5.0	0.15-0.6	2.0-7.0	0.2-0.75	2.0-7.0	0.2-0.75		
	R16 / R24										
MM2	R02										
	R04			1.0-4.0	0.1-0.5	2.0-6.0	0.15-0.7	2.0-7.0	0.15-0.7		
	R08			1.5-5.0	0.15-0.6	2.0-7.0	0.2-0.75	2.0-7.0	0.2-0.75		
	R12			1.5-5.0	0.15-0.6	2.0-7.0	0.2-0.75	2.0-7.0	0.2-0.75		
	R16 / R24										
MM3	R02										
	R04			1.0-4.0	0.1-0.5						
	R08			1.5-5.0	0.15-0.6						
	R12			1.5-5.0	0.15-0.6						
	R16 / R24									1.80-10.00	0.30-0.80
MM4	R02										
	R04			1.0-4.0	0.1-0.5						
	R08			1.5-5.0	0.15-0.6						
	R12			1.5-5.0	0.15-0.6						
	R16 / R24										

TURNING

GROOVING

THREADING

MILLING

DRILLING

ENDMILLS

DRILLS

SPARE PARTS

INDEX

negative / 네가티브



Cutting Parameters a_p (mm) & f_n (mm/rev) / 절삭 조건 (절입량 & 피드)

NEGATIVE INSERT SIZE		CN	-	1204..	1606..	1906..	2507.. 2509..
		DN	1104..	1504.. 1506..	-	-	-
		SN	0903..	1204..	-	1906..	2507.. 2509..
		TN	-	1604..	2204..	-	-
		VN	-	1604..	-	-	-
		WN	0604..	0804..	-	-	-

Chip Breaker Form	Corner Radius	a_p (mm)	f_n (mm/rev)	a_p (mm)	f_n (mm/rev)	a_p (mm)	f_n (mm/rev)	a_p (mm)	f_n (mm/rev)	a_p (mm)	f_n (mm/rev)
MR	R02										
	R04			0.8-5.0	0.15-0.3	1.0-7.0	0.2-0.4	1.3-8.0	0.2-0.5		
	R08			1.3-6.0	0.15-0.4	1.5-8.0	0.2-0.5	1.5-9.0	0.23-0.6		
	R12			1.5-6.5	0.15-0.45	2.0-9.0	0.22-0.5	2.0-10.0	0.25-0.7		
	R16 / R24			1.7-7.0	0.15-0.45	2.5-10.0	0.25-0.6	2.2-10.0	0.25-0.8		
MS	R02										
	R04			0.8-5.0	0.15-0.3	1.0-7.0	0.2-0.4				
	R08			1.3-6.0	0.15-0.4	1.5-8.0	0.2-0.5				
	R12			1.5-6.5	0.15-0.45	2.0-9.0	0.22-0.5				
	R16 / R24										
RB-25	R02										
	R04			0.8-5.0	0.15-0.3	1.0-7.0	0.2-0.4	1.3-8.0	0.2-0.5		
	R08			1.3-6.0	0.15-0.4	1.5-8.0	0.2-0.5	1.5-9.0	0.23-0.6		
	R12			1.5-6.5	0.15-0.45	2.0-9.0	0.22-0.5	2.0-10.0	0.25-0.7		
	R16 / R24			1.7-7.0	0.15-0.45	2.5-10.0	0.25-0.6	2.2-10.0	0.25-0.8		
RH-25	R02										
	R04			0.8-5.0	0.15-0.3	1.0-7.0	0.2-0.4	1.3-8.0	0.2-0.5		
	R08			1.3-6.0	0.15-0.4	1.5-8.0	0.2-0.5	1.5-9.0	0.23-0.6		
	R12			1.5-6.5	0.15-0.45	2.0-9.0	0.22-0.5	2.0-10.0	0.25-0.7		
	R16 / R24			1.7-7.0	0.15-0.45	2.5-10.0	0.25-0.6	2.2-10.0	0.25-0.8		
TQ	R02										
	R04			1.0-4.0	0.1-0.5						
	R08			1.5-5.0	0.15-0.6						
	R12			1.5-5.0	0.15-0.6						
	R16 / R24										
UF	R02										
	R04	0.3-1.5	0.1-0.3	0.5-2.0	0.1-0.4						
	R08	0.5-2.0	0.1-0.35	0.5-3.0	0.15-0.45						
	R12	0.5-2.5	0.1-0.4	1.0-3.5	0.15-0.45						
	R16 / R24										
UF1	R02										
	R04	0.3-1.5	0.1-0.3	0.5-2.0	0.1-0.4						
	R08	0.5-2.0	0.1-0.35	0.5-3.0	0.15-0.45						
	R12										
	R16 / R24										

negative / 네가티브



Cutting Parameters ap (mm) & fn (mm/rev) / 절삭 조건 (절입량 & 피드)

NEGATIVE INSERT SIZE		CN	-	1204..	1606..	1906..	2507.. 2509..
		DN	1104..	1504.. 1506..	-	-	-
		SN	0903..	1204..	-	1906..	2507.. 2509..
		TN	-	1604..	2204..	-	-
		VN	-	1604..	-	-	-
		WN	0604..	0804..	-	-	-

Chip Breaker Form	Corner Radius	ap (mm)	fn (mm/rev)	ap (mm)	fn (mm/rev)	ap (mm)	fn (mm/rev)	ap (mm)	fn (mm/rev)	ap (mm)	fn (mm/rev)
UM	R02										
	R04	0.5-2.5	0.1-0.3	1.0-4.0	0.1-0.5	2.0-6.0	0.15-0.7	2.0-7.0	0.15-0.7		
	R08	0.5-3.0	0.1-0.35	1.5-5.0	0.15-0.6	2.0-7.0	0.2-0.75	2.0-7.0	0.2-0.75		
	R12	0.5-3.5	0.1-0.4	1.5-5.0	0.15-0.6	2.0-7.0	0.2-0.75	2.0-7.0	0.2-0.75		
	R16 / R24										
UM1	R02										
	R04	0.5-2.5	0.1-0.3	1.0-4.0	0.1-0.5	2.0-6.0	0.15-0.7	2.0-7.0	0.15-0.7		
	R08	0.5-3.0	0.1-0.35	1.5-5.0	0.15-0.6	2.0-7.0	0.2-0.75	2.0-7.0	0.2-0.75		
	R12	0.5-3.5	0.1-0.4	1.5-5.0	0.15-0.6	2.0-7.0	0.2-0.75	2.0-7.0	0.2-0.75		
	R16 / R24	1.0-4.0	0.12-0.45	1.7-6.0	0.17-0.65	2.3-7.5	0.23-0.8	2.3-7.5	0.23-0.8		
UMC	R02										
	R04	0.5-2.5	0.1-0.3	1.0-4.0	0.1-0.5	2.0-6.0	0.15-0.7				
	R08	0.5-3.0	0.1-0.35	1.5-5.0	0.15-0.6	2.0-7.0	0.2-0.75				
	R12	0.5-3.5	0.1-0.4	1.5-5.0	0.15-0.6	2.0-7.0	0.2-0.75				
	R16 / R24									5.00-17.0	0.45-0.90
UR	R02										
	R04			0.8-5.0	0.15-0.3	1.0-7.0	0.2-0.4	1.3-8.0	0.2-0.5		
	R08			1.3-6.0	0.15-0.4	1.5-8.0	0.2-0.5	1.5-9.0	0.23-0.6		
	R12			1.5-6.5	0.15-0.45	2.0-9.0	0.22-0.5	2.0-10.0	0.25-0.7		
	R16 / R24			1.7-7.0	0.15-0.45	2.5-10.0	0.25-0.6	2.2-10.0	0.25-0.8		
UR1	R02										
	R04			0.8-5.0	0.15-0.3	1.0-7.0	0.2-0.4	1.3-8.0	0.2-0.5		
	R08			1.3-6.0	0.15-0.4	1.5-8.0	0.2-0.5	1.5-9.0	0.23-0.6		
	R12			1.5-6.5	0.15-0.45	2.0-9.0	0.22-0.5	2.0-10.0	0.25-0.7		
	R16 / R24			1.7-7.0	0.15-0.45	2.5-10.0	0.25-0.6	2.2-10.0	0.25-0.8		
Z	R02										
	R04										
	R08			0.1-0.35	1.5-5.0						
	R12			0.1-0.4	1.5-5.0						
	R16 / R24										
L-R	R02										
	R04			1.0-3.5	0.15-0.3						
	R08			1.2-4.0	0.15-0.4						
	R12										
	R16 / R24										

TURNING
GROOVING
THREADING
MILLING
DRILLING
ENDMILLS
DRILLS
SPARE PARTS
INDEX

positive / 포지티브



Cutting Parameters a_p (mm) & f_n (mm/rev) / 절삭 조건 (절입량 & 피드)

POSITIVE INSERT SIZE		CC / CP	0602..	09T3.. 0903..	1204..	-	-
		DC	0702..	11T3..	..	-	-
		SC / SP	-	09T3..	1204..	-	-
		TC / TP	0902..	1102..	16T3.. 2204..	-	-
		VB / VC	-	1103..	1604.. 2205..	-	-
		WB	0601..	-	-	-	-

Chip Breaker Form	Corner Radius	a_p (mm)	f_n (mm/rev)	a_p (mm)	f_n (mm/rev)	a_p (mm)	f_n (mm/rev)	a_p (mm)	f_n (mm/rev)	a_p (mm)	f_n (mm/rev)
AU	R02	0.05-2.5	0.01-0.12	0.05-3.0	0.02-0.2	0.05-3.5	0.02-0.3				
	R04	0.07-2.8	0.01-0.15	0.07-3.3	0.03-0.25	0.07-3.8	0.03-0.35				
	R08	0.1-3.0	0.03-0.2	0.1-3.5	0.05-0.3	0.1-4.5	0.05-0.4				
	R12										
	R16 / R24										
AU2C	R02										
	R04										
	R08										
	R12										
	R16 / R24							0.1-7.0	0.08-1.0		
AUP	R02										
	R04			0.05-3.0	0.02-0.2						
	R08			0.07-3.3	0.03-0.25						
	R12			0.1-3.5	0.05-0.3						
	R16 / R24							0.1-7.0	0.08-1.0		
GM	R02										
	R04					0.15-2.7	0.07-0.2				
	R08					0.18-3.5	0.1-0.23				
	R12					0.2-3.7	0.12-0.25				
	R16 / R24										
MF	R02	0.06-1.0	0.03-0.1	0.08-1.5	0.04-0.15	0.13-2.5	0.07-0.2				
	R04	0.08-1.3	0.05-0.15	0.1-2.0	0.07-0.2	0.15-3.0	0.1-0.23				
	R08	0.1-1.8	0.15-0.2	0.13-2.5	0.1-0.25	0.15-3.3	0.13-0.28				
	R12	0.12-2.3	0.18-0.25	0.15-3.0	0.12-0.3	0.17-3.5	0.15-0.35				
	R16 / R24										
MF1	R02	0.06-1.0	0.03-0.1	0.08-1.5	0.04-0.15	0.13-2.5	0.07-0.2				
	R04	0.08-1.3	0.05-0.15	0.1-2.0	0.07-0.2	0.15-3.0	0.1-0.23				
	R08	0.1-1.8	0.15-0.2	0.13-2.5	0.1-0.25	0.15-3.3	0.13-0.28				
	R12	0.12-2.3	0.18-0.25	0.15-3.0	0.12-0.3	0.17-3.5	0.15-0.35				
	R16 / R24										
MF2	R02	0.06-1.0	0.03-0.1	0.08-1.5	0.04-0.15	0.13-2.5	0.07-0.2				
	R04	0.08-1.3	0.05-0.15	0.1-2.0	0.07-0.2	0.15-3.0	0.1-0.23				
	R08	0.1-1.8	0.15-0.2	0.13-2.5	0.1-0.25	0.15-3.3	0.13-0.28				
	R12	0.12-2.3	0.18-0.25	0.15-3.0	0.12-0.3	0.17-3.5	0.15-0.35				
	R16 / R24										

positive / 포지티브



Cutting Parameters ap (mm) & fn (mm/rev) / 절삭 조건 (절입량 & 피드)

POSITIVE INSERT SIZE		CC / CP	0602..	09T3.. 0903..	1204..	-	-
		DC	0702..	11T3..	..	-	-
		SC / SP	-	09T3..	1204..	-	-
		TC / TP	0902..	1102..	16T3..	2204..	-
		VB / VC	-	1103..	1604..	2205..	-
		WB	0601..	-	-	-	-

Chip Breaker Form	Corner Radius	ap (mm)	fn (mm/rev)	ap (mm)	fn (mm/rev)	ap (mm)	fn (mm/rev)	ap (mm)	fn (mm/rev)	ap (mm)	fn (mm/rev)
MM1	R02	0.1-1.5	0.03-0.12	0.1-2.0	0.07-0.22	0.3-3.0	0.09-0.27				
	R04	0.2-2.0	0.06-0.2	0.15-2.5	0.1-0.28	0.5-3.3	0.1-0.3				
	R08	0.25-2.5	0.1-0.25	0.15-3.0	0.15-0.34	1.0-3.5	0.15-0.35				
	R12	0.25-2.8	0.1-0.3	0.2-3.5	0.2-0.35	1.0-3.5	0.15-0.4				
	R16 / R24										
MM3	R02			0.1-2.0	0.07-0.22						
	R04			0.15-2.5	0.1-0.28						
	R08			0.15-3.0	0.15-0.34						
	R12										
	R16 / R24										
MM4	R02					0.3-3.0	0.09-0.27				
	R04					0.5-3.3	0.1-0.3				
	R08					1.0-3.5	0.15-0.35				
	R12										
	R16 / R24										
MM5	R02	0.1-1.5	0.03-0.12	0.1-2.0	0.07-0.22	0.3-3.0	0.09-0.27				
	R04	0.2-2.0	0.06-0.2	0.15-2.5	0.1-0.28	0.5-3.3	0.1-0.3				
	R08	0.25-2.5	0.1-0.25	0.15-3.0	0.15-0.34	1.0-3.5	0.15-0.35				
	R12	0.25-2.8	0.1-0.3	0.2-3.5	0.2-0.35	1.0-3.5	0.15-0.4				
	R16 / R24										
SF	R02			0.06-1.0	0.03-0.13						
	R04			0.06-1.5	0.05-0.15						
	R08										
	R12										
	R16 / R24										
SF-OK	R02			0.06-1.0	0.03-0.13						
	R04			0.06-1.5	0.05-0.15						
	R08										
	R12										
	R16 / R24										
TQ	R02	0.06-1.0	0.03-0.1	0.08-1.5	0.04-0.15						
	R04	0.08-1.3	0.05-0.15	0.1-2.0	0.07-0.2						
	R08	0.1-1.8	0.15-0.2	0.13-2.5	0.1-0.25						
	R12	0.12-2.3	0.18-0.25	0.15-3.0	0.12-0.3						
	R16 / R24										

TURNING

GROOVING

THREADING

MILLING

DRILLING

ENDMILLS

DRILLS

SPARE PARTS

INDEX

positive / 포지티브



Cutting Parameters a_p (mm) & f_n (mm/rev) / 절삭 조건 (절입량 & 피드)

POSITIVE INSERT SIZE		CC / CP	0602..	09T3.. 0903..	1204..	-	-
		DC	0702..	11T3..	..	-	-
		SC / SP	-	09T3..	1204..	-	-
		TC / TP	0902..	1102..	16T3.. 2204..	-	-
		VB / VC	-	1103..	1604.. 2205..	-	-
		WB	0601..	-	-	-	-

Chip Breaker Form	Corner Radius	a_p (mm)	f_n (mm/rev)	a_p (mm)	f_n (mm/rev)	a_p (mm)	f_n (mm/rev)	a_p (mm)	f_n (mm/rev)	a_p (mm)	f_n (mm/rev)
UF	R02	0.06-1.0	0.03-0.1	0.08-1.5	0.04-0.15	0.13-2.5	0.07-0.2				
	R04	0.08-1.3	0.05-0.15	0.1-2.0	0.07-0.2	0.15-3.0	0.1-0.23				
	R08	0.1-1.8	0.15-0.2	0.13-2.5	0.1-0.25	0.15-3.3	0.13-0.28				
	R12	0.12-2.3	0.18-0.25	0.15-3.0	0.12-0.3	0.17-3.5	0.15-0.35				
	R16 / R24										
UM	R02	0.1-1.5	0.03-0.12	0.1-2.0	0.07-0.22	0.3-3.0	0.09-0.27				
	R04	0.2-2.0	0.06-0.2	0.15-2.5	0.1-0.28	0.5-3.3	0.1-0.3				
	R08	0.25-2.5	0.1-0.25	0.15-3.0	0.15-0.34	1.0-3.5	0.15-0.35				
	R12	0.25-2.8	0.1-0.3	0.2-3.5	0.2-0.35	1.0-3.5	0.15-0.4				
	R16 / R24										
UM2	R02	0.1-1.5	0.03-0.12	0.1-2.0	0.07-0.22	0.3-3.0	0.09-0.27				
	R04	0.2-2.0	0.06-0.2	0.15-2.5	0.1-0.28	0.5-3.3	0.1-0.3				
	R08	0.25-2.5	0.1-0.25	0.15-3.0	0.15-0.34	1.0-3.5	0.15-0.35				
	R12	0.25-2.8	0.1-0.3	0.2-3.5	0.2-0.35	1.0-3.5	0.15-0.4				
	R16 / R24										
UR	R02	0.1-1.5	0.03-0.12	0.1-2.0	0.07-0.22						
	R04	0.2-2.0	0.06-0.2	0.15-2.5	0.1-0.28						
	R08	0.25-2.5	0.1-0.25	0.15-3.0	0.15-0.34						
	R12	0.25-2.8	0.1-0.3	0.2-3.5	0.2-0.35						
	R16 / R24										
UR2	R02	0.1-1.5	0.03-0.12	0.1-2.0	0.07-0.22						
	R04	0.2-2.0	0.06-0.2	0.15-2.5	0.1-0.28						
	R08	0.25-2.5	0.1-0.25	0.15-3.0	0.15-0.34						
	R12	0.25-2.8	0.1-0.3	0.2-3.5	0.2-0.35						
	R16 / R24										

TURNING 터닝

TURNING CVD Comparison table (터닝 CVD 재종 비교표)

MATERIAL 피삭재	K-CERA	ISCAR	SECO	TEAGUTEC	KYOCERA	SANDVIK	KENAMETAL	MITSUBISHI	WALTER	KORLOY
P	TC5210		TP0500	TT8105	CA5505	GC4305	KCP05(B)	UE6105	WPP10S	NC3010
	TC5110	IC8150	TP0501	TT8110	CA510	GC4205		UE6110	WKP13S	
			TP1500	TT8115	CA515	GC4315	KCP10(B)	MY5015		NC3215
	TC5220		TP2500	TT8120	CA525	GC4215		MC6025	WPP20S	NC3220
	TC5120	IC8250	TP2501	LC025P	CA5525	GC4325	KCP25(B)	UE6020	WKP23S	NC3225
			T350M	TT8125		GC4225				
	TC5230	IC8350	TP3500	TT5100	CA530	GC4235	KCP30(B)	UE6035	WPP30S	NC3030
				TT8135	CA5535				WKP33S	NC500H
TC5240		TGP45	TT7100				KCP40(B)		NC5330	
M	TC6125	IC6015	TM2000	TT9215	CA6515	GC2015	KCM15(M)	MC7015	WAM10	NC9020
			TM4000	TT9225	CA6525	GC2025	KCM25(B)	US7020	WAM20	NC9025
								US735	WAM30	
K	TC4105	IC5005	TK1001	TT7005	CA4505	GC3205	KCK05(B)	MC5005	WKK10S	NC6205
					CA4010	GC3210		UC5105		
	TC4215			TT7310						NC6210
	TC4115D	IC5015	TK2001	TT7015	CA4515	GC3215	KCK15(B)	MC5015	WKK20S	NC6215
	TC4315		TGK1500		CA4115	GC3225		UC5115		

TURNING Cermet Coated(터닝 코팅 써메트 재종 비교표)

MATERIAL 피삭재	K-CERA	ISCAR	SECO	TEAGUTEC	KYOCERA	SANDVIK	KENAMETAL	MITSUBISHI	WALTER	KORLOY
UNI										
	TT5115	IC20N	C15M	CT3000	TN60	CT525	KT125	NX2525		CC1500
		IC520N					HT5	NX3035		CN1500

TURNING Cermet Coated(터닝 코팅 써메트 재종 비교표)

MATERIAL 피삭재	K-CERA	ISCAR	SECO	TEAGUTEC	KYOCERA	SANDVIK	KENAMETAL	MITSUBISHI	WALTER	KORLOY
UNI										
	TTP5115			PV3010	PV7020	GC1525		UP35N	WTA43	CC115

- TURNING
- GROOVING
- THREADING
- MILLING
- DRILLING
- ENDMILLS
- DRILLS
- SPARE PARTS
- INDEX

TURNING PVD Comparison table(터닝 PVD 재종 비교표)

MATERIAL 피삭재	K-CERA	ISCAR	SECO	TEAGUTEC	KYOCERA	SANDVIK	KENAMETAL	MITSUBISHI	WALTER	KORLOY
P	TP0005(H)P	IC507	CP200		PR1005					
	TP0105P	IC808			PR915		KU10T			PC8110
	TP0010P		CP250		PR1115		KU25T			PC230
					PR930					
	TP0015P	IC3028		TT5030		GC1025		VP15TF	WTA43	PC5300
	TP0115P	IC908			PR1025			VP20MF	WTA41	PC8115
		IC830			PR630	GC4125				
TP0025		CP500		PR660					PC3545	
M	TP0005(H)P	IC808	CP200			GC1005		MP9005		
	TP0105P	IC907			PR915	GC1105	KC5010	VP10RT	WSM10S	PC8110
	TP0010P		CP250				KC5510		WSM20S	PC8115
					PR930	GC1020				
	TP0015P	IC3028					KC5025	VP15TF	WSM30S	PC5300
	TP0115P	IC830		TT5030	PR1125	GC1025	KC5525	VP20MF	WSM40S	
					PR630	GC4125				PC9030
TP0025		CP500	TT8020	PR660	GC2035				PC5400	
K	TP4505	IC810	CP200							
		IC908	CP250	TT5030						
	TP0025	IC228	CP500							PC5300
S										
	TP0005(H)P	IC808	TS2000					VP05RT	WSM10	PC8105
	TP0105P	IC907			PR915	GC1105				
	TP6505P		CP500				KC5010	VP10RT	WSM20	PC8110
										PC8115
	TP6015	IC328	TS2500	TT5030	PR660	GC1025		VP15TF	WSM30	
	TP6025				PR1325	GC2035	KC5025			PC5300
TP6035									PC5400	

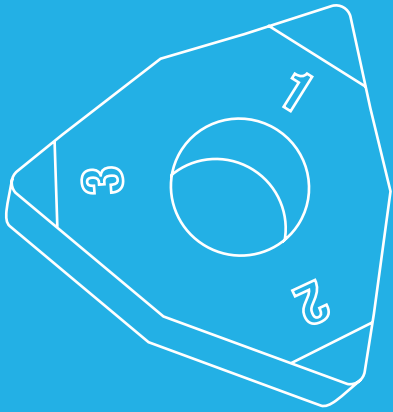

TURNING / PCBN
터닝 / PCBN 인서트

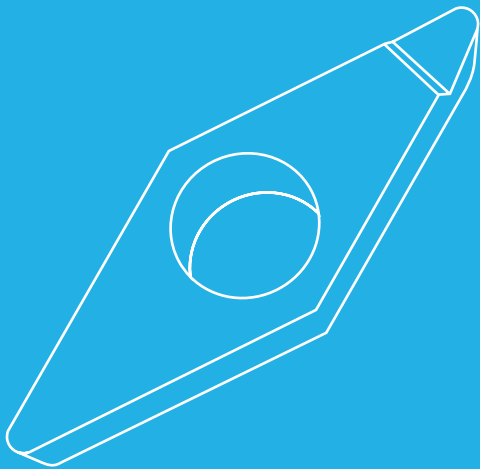
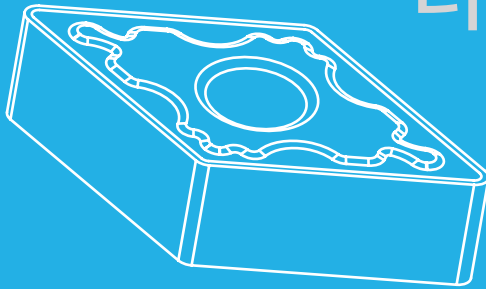

C

1

C

2

G

3

W

4

12

5

04

6

08

7

1 Geometry/인서트 형상

C		80
D		55
R		360
S		90
T		60
V		35
W		80

2 Clearance Angle 주절인 여유각

B		5°
C		7°
P		11°
N		0°

3 Tolerance/공차

G	±0.025	±0.13
M	±0.05 ±0.15	±0.13
U	±0.08 ±0.25	±0.13

4 Shape/단면형상

A	
G	
M	
W	
X	Special

5 Shape/인선길이(mm)

C	06 09 12 16 19 25	
D	07 11 15	
R	06 09 12 15 19 25	
S	09 12 15 19 25	
T	09 11 16 22	
V	11 16 22	
W	06 08	

6 Thickness (mm) 인선높이(메트릭)

02	2.38
03	3.18
T3	3.97
04	4.76
06	6.35
07	7.94
09	9.52
10	10.00

7 Corner Radius 노즈(nose) "r" 크기(메트릭)

02	0.20 mm
04	0.40 mm
08	0.80 mm
12	1.20 mm
16	1.60 mm
24	2.40 mm

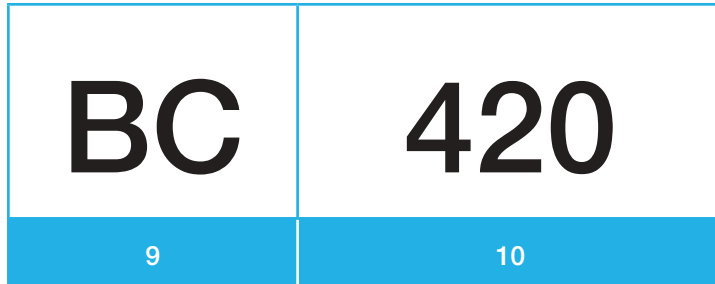

8	Number of Edges 코너수
1C	1 Corner
2C	2 Corners
3C	3 Corners
4C	4 Corners
6C	6 Corners
8C	8 Corners
FF	Full Face
SO	Solid PcBN

9	Coating / Non-Coating 코팅 / 비코팅
BC	비코팅(non-coating)
SC	코팅(coating)

10	Application 적용영역
1	Hardened Steel/ 열처리강
2	Cast Iron/ 주철
3	Super Alloy/ 고합금강
4	Universal/ 범용

TURNING

GROOVING

THREADING

MILLING

DRILLING

ENDMILLS

DRILLS

SPARE PARTS

INDEX

Grades/ 재종

ISO DIN 513	K					H					S				
	K01	K10	K20	K30	K40	P01	P10	P20	P30	P40	S01	S10	S20	S30	S40
PCBN	BC250					BC150					BC350				
	SC250					BC170									
						SC150									
	BC420					BC420									

COATED

TURNING 터닝

POSITIVE 7°
with hole

CC□□

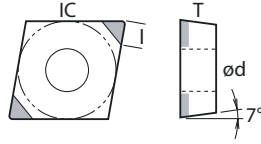

CC	0602	09T3	1204
IC	6,35	9,525	12,7
T	2,38	3,97	4,76
ød	2,80	4,40	5,50
Holder	120	120	120

DESCRIPTION 형번		EDGE 코너수	PCBN						
			BC150	BC170	SC150	BC250	SC250	BC350	BC420
	CCGW060202	1C	•			•	•		•
	CCGW060204	1C	•	•	•	•	•	•	•
	CCGW060208	1C		•		•	•		•
	CCGW09T302	1C	•			•	•		•
	CCGW09T304	1C	•	•	•	•	•	•	•
	CCGW09T308	1C		•		•	•		•
	CCGW120404	1C	•	•	•	•	•		•
	CCGW120408	1C		•		•	•	•	•
	CCGW060202	2C	•			•	•		•
	CCGW060204	2C	•	•	•	•	•	•	•
	CCGW060208	2C		•		•	•		•
	CCGW09T302	2C	•			•	•		•
	CCGW09T304	2C	•	•	•	•	•	•	•
	CCGW09T308	2C		•		•	•		•
	CCGW120404	2C	•	•	•	•	•		•
	CCGW120408	2C		•		•	•	•	•



터닝
그루브
나사
민공
인테셔널 드릴
엔드밀
솔리드 드릴
부품
색인표

NEGATIVE with hole

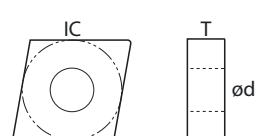
CN □□

CN	1204
IC	12,7
T	4,76
Ød	5,16
Holder	125

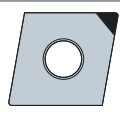
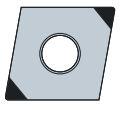
DESCRIPTION 형번	EDGE 코너수	PCBN								
		BC150	BC170	SC150	BC250	SC250	BC350	BC420		
	CNGA120404	1C	●							●
	CNGA120408	1C	●	●	●	●	●	●	●	●
	CNGA120412	1C				●	●			●
	CNGA120404	2C	●							●
	CNGA120408	2C	●	●	●	●	●	●	●	●
	CNGA120412	2C				●	●			●
	CNGA120404	4C	●							●
	CNGA120408	4C	●	●	●	●	●	●	●	●
	CNGA120412	4C				●	●	●		●

TURNING 터닝

**POSITIVE 7°
with hole**

DC □□

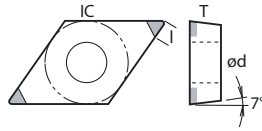

DC	0702	11T3
IC	6,35	9,525
T	2,38	3,97
ød	2,80	4,40
Holder	133	133

DESCRIPTION 형번		EDGE 코너수	PCBN						
			BC150	BC170	SC150	BC250	SC250	BC350	BC420
	DCGW070202	1C	●						●
	DCGW070204	1C	●	●	●	●	●	●	●
	DCGW070208	1C				●	●		●
	DCGW11T302	1C	●						●
	DCGW11T304	1C	●	●	●	●	●	●	●
	DCGW11T308	1C				●	●		●
	DCGW070202	2C	●						●
	DCGW070204	2C	●	●	●	●	●	●	●
	DCGW070208	2C				●	●		●
	DCGW11T302	2C	●						●
	DCGW11T304	2C	●	●	●	●	●	●	●
	DCGW11T308	2C				●	●		●

- TURNING
- GROOVING
- THREADING
- MILLING
- DRILLING
- ENDMILLS
- DRILLS
- SPARE PARTS
- INDEX

터닝

그루비

나사

면밀

인테셔널 드릴

엔드밀

솔리드 드릴

부품

색인표

**NEGATIVE
with hole**

DN □ □

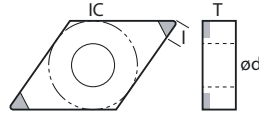

DN	1504	1506
IC	12,7	12,7
T	4,76	6,35
ød	5,16	5,16
Holder	142	142

DESCRIPTION 형번	EDGE 코너수	PCBN								
		BC150	BC170	SC150	BC250	SC250	BC350	BC420		
	DNGA150404	1C	●							●
	DNGA150408	1C	●	●	●	●	●	●	●	●
	DNGA150604	1C	●							●
	DNGA150608	1C	●	●	●	●	●	●	●	●
	DNGA150612	1C		●	●	●	●			●
	DNGA150404	2C	●							●
	DNGA150408	2C	●	●	●	●	●	●	●	●
	DNGA150604	2C	●							●
	DNGA150608	2C	●	●	●	●	●	●	●	●
	DNGA150612	2C		●	●	●	●			●
	DNGA150404	4C	●							●
	DNGA150408	4C	●	●	●	●	●	●	●	●
	DNGA150604	4C	●							●
	DNGA150608	4C	●	●	●	●	●	●	●	●
	DNGA150612	4C		●	●	●	●			●

POSITIVE 7°
without hole

RC□□

 360

RC	0603	0903	1204
IC	6,35	9,525	12,7
T	3,18	3,18	4,76
Ød	-	-	-
Holder			

DESCRIPTION 형번	EDGE 코너수	PCBN							
		BC150	BC170	SC150	BC250	SC250	BC350	BC420	
	RCGX060300	FF	●	●					●
	RCGX090300	FF	●	●					●
	RCGX120400	FF	●	●					●

- TURNING
- GROOVING
- THREADING
- MILLING
- DRILLING
- ENDMILLS
- DRILLS
- SPARE PARTS
- INDEX

터닝
 그루브
 나사
 밀링
 인터서블 드릴
 엔드밀
 슬리드 드릴
 부품
 색인표

**POSITIVE 7°
without hole**

RC□□

360

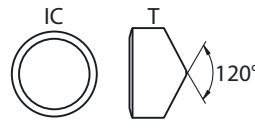

RC	0603	0903	1204
IC	6,35	9,525	12,7
T	3,18	3,18	4,76
Ød	-	-	-

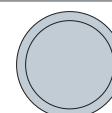

DESCRIPTION 형번		EDGE 코너수	PCBN							
			BC150	BC170	SC150	BC250	SC250	BC350	BC420	
	RCGX060300	SO								●
	RCGX090300	SO								●
	RCGX120400	SO								●



TURNING 터닝

NEGATIVE
without hole

RN□□

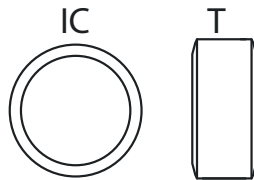

RN	0603	0903	1204
IC	6,35	9,525	12,70
T	3,18	3,18	4,76
∅d	-	-	-

DESCRIPTION 형번	EDGE 코너수	PCBN							
		BC150	BC170	SC150	BC250	SC250	BC350	BC420	
	RNGN060300	SO							●
	RNGN090300	SO							●
	RNGN120400	SO							●

Vc ● fn ● ap ▶ 94

- TURNING
- GROOVING
- THREADING
- MILLING
- DRILLING
- ENDMILLS
- DRILLS
- SPARE PARTS
- INDEX

터닝

그루브

나사

민원

인테셔널 드릴

엔드밀

슬리드 드릴

부품

색인표

**NEGATIVE
with hole**

SN □□

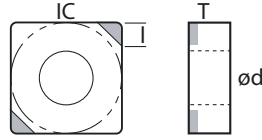

SN	1204
IC	12,7
T	4,76
ød	5,16
Holder	156

DESCRIPTION 형번	EDGE 코너수	PCBN							
		BC150	BC170	SC150	BC250	SC250	BC350	BC420	
	SNGA120404	1C	●						●
	SNGA120408	1C	●	●					●
	SNGA120412	1C		●					●
	SNGA120404	2C	●						●
	SNGA120408	2C	●	●					●
	SNGA120412	2C		●					●
	SNGA120404	4C	●						●
	SNGA120408	4C	●	●					●
	SNGA120412	4C		●					●
	SNGA120404	8C	●						●
	SNGA120408	8C	●	●					●
	SNGA120412	8C		●					●

POSITIVE 7°
with hole

TC □□

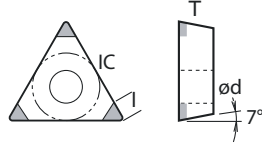

TC	0902	1102	16T3
IC	5,56	6,35	9,525
T	2,38	2,38	3,97
ød	2,50	2,80	4,40
Holder	163	163	163

DESCRIPTION 형번		EDGE 코너수	PCBN							
			BC150	BC170	SC150	BC250	SC250	BC350	BC420	
	TCGW090202	1C	●							●
	TCGW090204	1C	●	●	●	●	●			●
	TCGW110202	1C	●					●		●
	TCGW110204	1C	●	●	●	●	●			●
	TCGW110208	1C		●						●
	TCGW16T304	1C	●							●
	TCGW16T308	1C	●	●					●	●
	TCGW090202	3C	●							●
	TCGW090204	3C	●	●	●	●	●			●
	TCGW110202	3C	●					●		●
	TCGW110204	3C	●	●	●	●	●			●
	TCGW110208	3C		●						●
	TCGW16T304	3C	●							●
	TCGW16T308	3C	●	●					●	●

- 터닝
- 그루빙
- 나사
- 밀링
- 인테셔널 드릴
- 엔드밀
- 솔리드 드릴
- 부품
- 색인표

**NEGATIVE
with hole**

TN □□

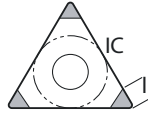

TN	1604
IC	9,525
T	4,76
$\varnothing d$	3,81
Holder	▶ 170

DESCRIPTION 형번	EDGE 코너수	PCBN								
		BC150	BC170	SC150	BC250	SC250	BC350	BC420		
	TNGA160404	1C	•							•
	TNGA160408	1C	•	•	•	•	•	•		•
	TNGA160412	1C				•	•			•
	TNGA160404	3C	•							•
	TNGA160408	3C	•	•	•	•	•	•		•
	TNGA160412	3C				•	•			•

POSITIVE 11°
with hole

TP

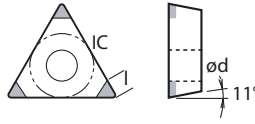

TP	0802	0902	1103
IC	4,76	5,56	6,35
T	2,38	2,38	3,18
ød	2,30	3,00	3,40
Holder	169	169	169

DESCRIPTION 형번		EDGE 코너수	PCBN						
			BC150	BC170	SC150	BC250	SC250	BC350	BC420
	TPGW080202	1C	•						•
	TPGW080204	1C	•	•	•				•
	TPGW090202	1C	•						•
	TPGW090204	1C	•	•	•				•
	TPGW110302	1C	•						•
	TPGW110304	1C	•	•	•	•			•
	TPGW110308	1C		•	•	•			•
	TPGW080202	3C	•						•
	TPGW080204	3C	•	•	•				•
	TPGW090202	3C	•						•
	TPGW090204	3C	•	•	•				•
	TPGW110302	3C	•						•
	TPGW110304	3C	•	•	•	•			•
	TPGW110308	3C		•	•	•			•

터닝

그루비

나사

면밀

인테서블 드릴

엔드밀

솔리드 드릴

부품

색인표

**POSITIVE 5°
with hole**

VB □□

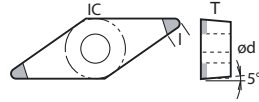

VB	1103	1604
IC	6,35	9,525
T	3,18	4,76
Ød	2,80	4,40
Holder	175	175

DESCRIPTION 형번	EDGE 코너수	PCBN								
		BC150	BC170	SC150	BC250	SC250	BC350	BC420		
	VBGW110302	1C	•							•
	VBGW110304	1C	•	•	•	•				•
	VBGW160402	1C	•			•		•		•
	VBGW160404	1C	•	•	•					•
	VBGW160408	1C	•							•
	VBGW110302	2C	•							•
	VBGW110304	2C	•	•	•	•				•
	VBGW160402	2C	•			•		•		•
	VBGW160404	2C	•	•	•					•
	VBGW160408	2C	•							•

Vc • fn • ap ▶ 94

POSITIVE 7°
with hole

VC □□

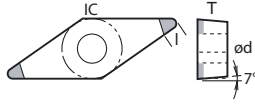

VC	1103	1604
IC	6,35	9,525
T	3,18	4,76
ød	2,80	4,40
Holder	181	181

DESCRIPTION 형번	EDGE 코너수	PCBN							
		BC150	BC170	SC150	BC250	SC250	BC350	BC420	
	VCGW110302	1C	●						●
	VCGW110304	1C	●	●	●	●			●
	VCGW160404	1C	●			●		●	●
	VCGW160408	1C	●	●	●				●
	VCGW110302	2C	●						●
	VCGW110304	2C	●	●	●	●			●
	VCGW160404	2C	●			●		●	●
	VCGW160408	2C	●	●	●				●

- TURNING
- GROOVING
- THREADING
- MILLING
- DRILLING
- ENDMILLS
- DRILLS
- SPARE PARTS
- INDEX

터닝

**NEGATIVE
with hole**

VN □ □

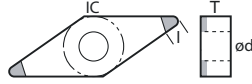

VN	1604
IC	9,525
T	4,76
ød	3,81
Holder	183

그루비

나사

민공

인테셔널 드릴

엔드밀

슬리드 드릴

부품

색인표

DESCRIPTION 형번		EDGE 코너수	PCBN						
			BC150	BC170	SC150	BC250	SC250	BC350	BC420
	VNGA160404	1C	●			●	●	●	●
	VNGA160408	1C	●	●	●	●	●	●	●
	VNGA160404	2C	●			●	●		●
	VNGA160408	2C	●	●	●	●	●	●	●
	VNGA160404	4C	●			●	●		●
	VNGA160408	4C	●	●	●	●	●	●	●

TURNING 터닝

NEGATIVE
with hole

WN□□

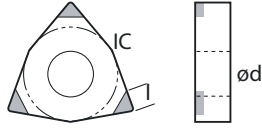

WN	0604	0804
IC	9,525	12,7
T	4,76	4,76
ød	3,81	5,16
Holder	186	186

DESCRIPTION 형번		EDGE 코너수	PCBN						
			BC150	BC170	SC150	BC250	SC250	BC350	BC420
	WNGA060404	1C	●						●
	WNGA060408	1C	●						●
	WNGA080404	1C	●						●
	WNGA080408	1C	●	●		●		●	●
	WNGA080412	1C		●				●	●
	WNGA060404	3C	●						●
	WNGA060408	3C	●						●
	WNGA080404	3C	●						●
	WNGA080408	3C	●	●		●		●	●
	WNGA080412	3C		●				●	●
	WNGA080404	6C	●						●
	WNGA080408	6C	●	●		●		●	●
	WNGA080412	6C		●				●	●

- TURNING
- GROOVING
- THREADING
- MILLING
- DRILLING
- ENDMILLS
- DRILLS
- SPARE PARTS
- INDEX

Cutting Parameters / 절삭 조건

FC	회주철 GREY CAST IRON
FCD	덕타일 NODULAR CAST IRON
WMC	백심가단주철 WHITE CAST IRON
KS	소결품 SINTERED MATERIAL

STR	내열강 HARDENED STEEL
CS	표면경화강 CASE HARDENED STEEL
KM	베어링강 BEARING STEEL
HRSA	난삭재 SUPER ALLOYS (Ni Based)

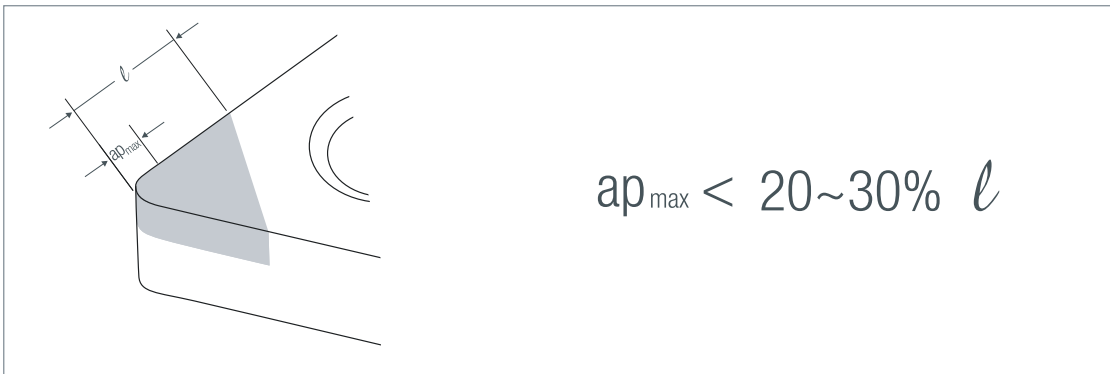

MATERIAL 피삭재	ap (mm)	fn (mm/ rev)	CUTTING CONDITION	PCBN							
				BC150	BC170	SC150	BC250	SC250	BC350	BC420	
H	STR	0,05~0,25	0,05~0,20	○ ◊ ◊	120-250	100-230	100-200				100-220
				⊕ ◊			80-180			80-180	
	CS	0,05~0,25	0,08~0,25	○ ◊ ◊			100-180				100-200
⊕ ◊						80-160			80-160		
KM	0,05~0,25	0,05~0,20	○ ◊ ◊	120-220	100-200	100-180				100-200	
			⊕ ◊			80-150			90-150		
K	FC	0,10~0,50	0,10~0,30	○ ◊ ◊					400-1000		400-1200
				⊕ ◊					400-800		400-1000
	FCD	0,10~0,30	0,05~0,20	○ ◊				250-400			250-500
				⊕ ◊				150-300			200-400
	WMC	0,10~0,30	0,10~0,30	○ ◊					60-100		60-120
⊕ ◊								50-80		50-100	
KS	0,05~0,20	0,05~0,25	○ ◊				160-250	160-250			160-280
			⊕ ◊								120-220
S	HRSA	0,05~0,20	0,10~0,20	○ ◊						120-300	

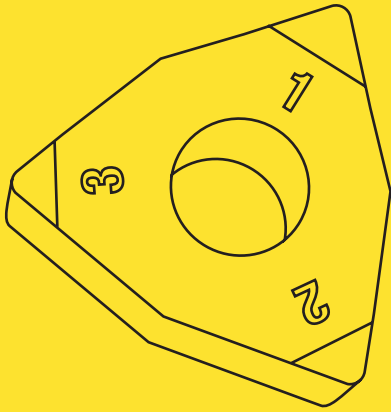

TURNING / diamond

터닝 / 다이아몬드
PCD

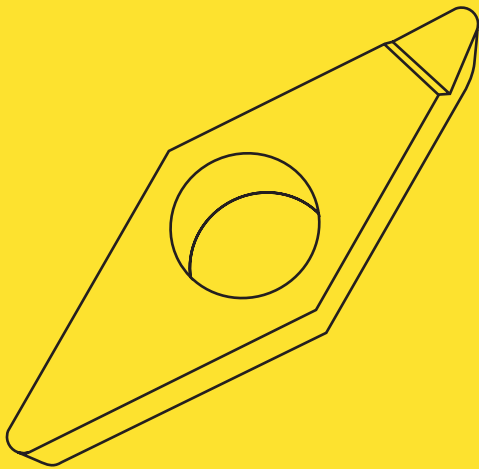
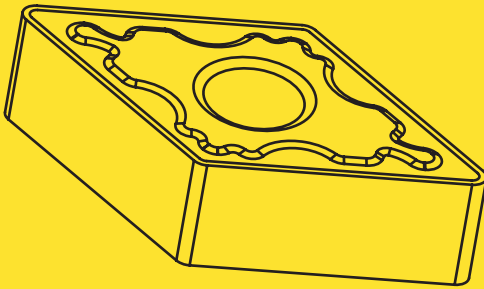

D C G W 11 T3 04

1

2

3

4

5

6

7

1 Geometry/ 인서트 형상

C		80
D		55
R		360
S		90
T		60
V		35
W		80

2 Clearance Angle 주절인 여유각

B		5°
C		7°
P		11°
N		0°

3 Tolerance/공차

G	±0.025	±0.13
M	±0.05 ±0.15	±0.13
U	±0.08 ±0.25	±0.13

4 Shape/단면형상

A	
G	
M	
W	
X	Special

5 Shape인선길이(mm)

C	06 09 12 16 19 25	
D	07 11 15	
R	06 09 12 15 19 25	
S	09 12 15 19 25	
T	09 11 16 22	
V	11 16 22	
W	06 08	

6 Thickness (mm) 인선높이(메트릭)

02	2.38
03	3.18
T3	3.97
04	4.76
06	6.35
07	7.94
09	9.52
10	10.00

7 Corner Radius 노즈(nose) "r" 크기(메트릭)

02	0.20 mm
04	0.40 mm
08	0.80 mm
12	1.20 mm
16	1.60 mm
24	2.40 mm

1C

8

PC

9

150

10

8	Number of Edges 코너수
1C	1 Corner
2C	2 Corners
3C	3 Corners
FE	Full Edge

9	Grade 재종
PC	PCD

10	Application 적용영역
1 3	Non - Ferrous Metal 비철금속

- TURNING
- GROOVING
- THREADING
- MILLING
- DRILLING
- ENDMILLS
- DRILLS
- SPARE PARTS
- INDEX

Grades / 재종

ISO DIN 513	N				
	N01	N10	N20	N30	N40
PCD			PC100		
		PC150			
		PC200			
	PC300				

CUTTING EDGE STYLE

인선 형상

POSITIVE INSERTS

포지티브 인서트

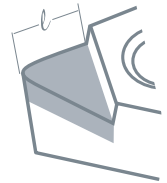
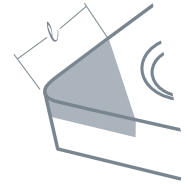

NEGATIVE INSERTS

네가티브 인서트

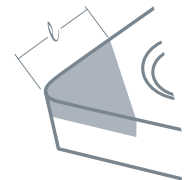







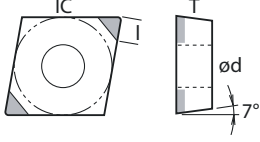

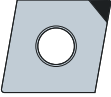

**POSITIVE 7°
with hole**

CC □ □

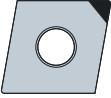

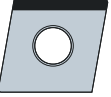

CC	0602	09T3	1204
IC	6,35	9,525	12,7
T	2,38	3,97	4,76
ød	2,80	4,40	5,50
Holder	120	120	120

DESCRIPTION 형번		EDGE 코너수		PCD					
				PC100	PC150	PC200	PC300		
	CCGT060202	1C		●	●	●	●		
	CCGT060204	1C		●	●	●	●		
	CCGT060208	1C		●	●	●	●		
	CCGT09T302	1C		●	●	●	●		
	CCGT09T304	1C		●	●	●	●		
	CCGT09T308	1C		●	●	●	●		
	CCGT120404	1C		●	●	●	●		
	CCGT120408	1C		●	●	●	●		
	CCGT09T302	2C		●	●	●	●		
	CCGT09T304	2C		●	●	●	●		
	CCGT09T308	2C		●	●	●	●		
	CCGT120404	2C		●	●	●	●		
	CCGT120408	2C		●	●	●	●		
	CCGW060202	1C		●	●	●	●		
	CCGW060204	1C		●	●	●	●		
	CCGW060208	1C		●	●	●	●		
	CCGW09T302	1C		●	●	●	●		
	CCGW09T304	1C		●	●	●	●		
	CCGW09T308	1C		●	●	●	●		
	CCGW120404	1C		●	●	●	●		
	CCGW120408	1C		●	●	●	●		
	CCGW09T302	2C		●	●	●	●		
	CCGW09T304	2C		●	●	●	●		
	CCGW09T308	2C		●	●	●	●		
	CCGW120404	2C		●	●	●	●		
	CCGW120408	2C		●	●	●	●		
	CCGX060204R/L	FE		●	●	●	●		
	CCGX09T304R/L	FE		●	●	●	●		

Vc ● fn ● ap 109

- TURNING
- GROOVING
- THREADING
- MILLING
- DRILLING
- ENDMILLS
- DRILLS
- SPARE PARTS
- INDEX



- 터닝
- 그루브
- 나사
- 미링
- 인테셔널 드릴
- 엔드밀
- 솔리드 드릴
- 부품
- 색인표

NEGATIVE
with hole

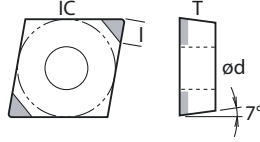
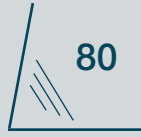
CN□□

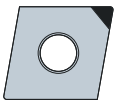

CN	1204
IC	12,7
T	4,76
Ød	5,16
Holder	125

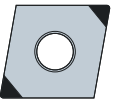
DESCRIPTION 형번	EDGE 코너수	Image	PCD					
			PC100	PC150	PC200	PC300		
 CNGA120404	1C			●	●	●		
	CNGA120408		1C	●	●	●		
 CNGA120404	2C			●	●	●		
	CNGA120408		2C	●	●	●		



POSITIVE 7°
with hole

DC □□

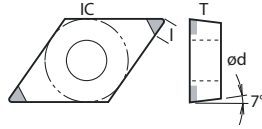

DC	0702	11T3
IC	6,35	9,525
T	2,38	3,97
Ød	2,80	4,40
Holder	133	133

DESCRIPTION 형번	EDGE 코너수		PCD					
			PC100	PC150	PC200	PC300		
	DCGT070202	1C		●	●	●		
	DCGT070204	1C	●	●	●	●		
	DCGT070208	1C	●	●		●		
	DCGT11T302	1C		●	●	●		
	DCGT11T304	1C	●	●	●	●		
	DCGT11T308	1C	●	●		●		
	DCGT11T302	2C		●	●	●		
	DCGT11T304	2C	●	●	●	●		
	DCGT11T308	2C	●	●		●		
	DCGW070202	1C		●	●	●		
	DCGW070204	1C	●	●	●	●		
	DCGW070208	1C	●	●		●		
	DCGW11T302	1C		●	●	●		
	DCGW11T304	1C	●	●	●	●		
	DCGW11T308	1C	●	●		●		
	DCGW11T302	2C		●	●	●		
	DCGW11T304	2C	●	●	●	●		
	DCGW11T308	2C	●	●		●		
	DCGX070204R/L	FE		●		●		
	DCGX11T304R/L	FE		●		●		

터닝

그루브

나사

밀링

인테셔널 드릴

엔드밀

슬리드 드릴

부품

색인표

NEGATIVE
with hole

DN

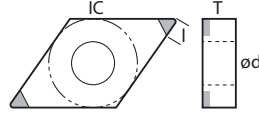

DN	1504	1506
IC	12,7	12,7
T	4,76	6,35
Ød	5,16	5,16
Holder	142	142

DESCRIPTION 형번		EDGE 코너수	Image	PCD					
				PC100	PC150	PC200	PC300		
	DNGA150604	1C			●	●	●		
	DNGA150608	1C		●	●		●		
	DNGA150604	2C			●	●	●		
	DNGA150608	2C		●	●		●		

POSITIVE 7°
with hole

TC □□

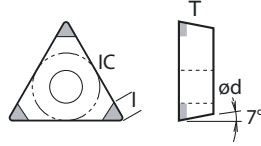

TC	0902	1102	16T3
IC	5,56	6,35	9,525
T	2,38	2,38	3,97
Ød	2,50	2,80	4,40
Holder	163	163	163

DESCRIPTION 형번	EDGE 코너수		PCD					
			PC100	PC150	PC200	PC300		
	TCGT090202	1C		•	•	•		
	TCGT090204	1C	•	•	•	•		
	TCGT110202	1C		•	•	•		
	TCGT110204	1C	•	•	•	•		
	TCGT110208	1C	•	•		•		
	TCGT16T304	1C	•	•	•	•		
	TCGT16T308	1C	•	•		•		
	TCGT16T304	3C	•	•	•	•		
	TCGT16T308	3C	•	•		•		
	TCGW090202	1C		•	•	•		
	TCGW090204	1C	•	•	•	•		
	TCGW110202	1C		•	•	•		
	TCGW110204	1C	•	•	•	•		
	TCGW110208	1C	•	•		•		
	TCGW16T304	1C	•	•	•	•		
	TCGW16T308	1C	•	•		•		
	TCGW16T304	3C	•	•	•	•		
	TCGW16T308	3C	•	•		•		
	TCGX090204R/L	FE		•		•		
	TCGX110204R/L	FE		•		•		
	TCGX16T304R/L	FE		•		•		

Vc • fn • ap 109

터닝

그루브

나사

미림

인테셔널 드릴

엔드밀

솔리드 드릴

부품

색인표

NEGATIVE with hole

TN □□

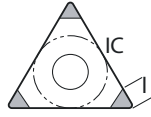

TN	1604
IC	9,525
T	4,76
ød	3,81
Holder	170

DESCRIPTION 형번		EDGE 코너수		PCD					
				PC100	PC150	PC200	PC300		
	TNGA160404	1C			•	•	•		
	TNGA160408	1C		•	•		•		
	TNGA160404	3C			•	•	•		
	TNGA160408	3C		•	•		•		
	TNGA160404	6C			•	•	•		
	TNGA160408	6C		•	•		•		

**POSITIVE 11°
with hole**

TP □ □



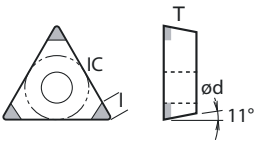

TP	0802	0902	1103
IC	4,76	5,56	6,35
T	2,38	2,38	3,18
Ød	2,30	3,00	3,40
Holder	169	169	169

DESCRIPTION 형번		EDGE 코너수	Image	PCD						
				PC100	PC150	PC200	PC300			
	TPGT080202	1C			●	●	●			
	TPGT080204	1C			●	●	●			
	TPGT090202	1C			●	●	●			
	TPGT090204	1C			●	●	●			
	TPGT110302	1C				●	●	●		
	TPGT110304	1C			●	●	●	●		
	TPGW080202	1C			●	●	●			
	TPGW080204	1C			●	●	●			
	TPGW090202	1C			●	●	●			
	TPGW090204	1C			●	●	●			
	TPGW110302	1C				●	●	●		
	TPGW110304	1C			●	●	●	●		

터닝
그루브
나사
밀링
인테셔널 드릴
엔드밀
솔리드 드릴
부품
색인표

POSITIVE 5°
with hole

VB □□

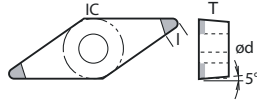

VB	1103	1604
IC	6,35	9,525
T	3,18	4,76
Ød	2,80	4,40
Holder	175	175

DESCRIPTION 형번	EDGE 코너수		PCD					
			PC100	PC150	PC200	PC300		
VBGT110302	1C			●	●	●		
	VBGT110304		1C	●	●	●	●	
	VBGT160402		1C	●	●	●	●	
	VBGT160404		1C	●	●	●	●	
	VBGT160408		1C	●	●		●	
VBGT110302	2C			●	●	●		
	VBGT110304		2C	●	●	●	●	
	VBGT160402		2C	●	●	●	●	
	VBGT160404		2C	●	●	●	●	
	VBGT160408		2C	●	●		●	
VBGW110302	1C			●	●	●		
	VBGW110304		1C	●	●	●	●	
	VBGW160402		1C	●	●	●	●	
	VBGW160404		1C	●	●	●	●	
	VBGW160408		1C	●	●		●	
VBGW110302	2C			●	●	●		
	VBGW110304		2C	●	●	●	●	
	VBGW160402		2C	●	●	●	●	
	VBGW160404		2C	●	●	●	●	
	VBGW160408		2C	●	●		●	

POSITIVE 7°
with hole

VC □□

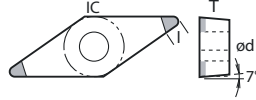

VC	1103	1604
IC	6,35	9,525
T	3,18	4,76
Ød	2,80	4,40
Holder	181	181



DESCRIPTION 형번	EDGE 코너수		PCD					
			PC100	PC150	PC200	PC300		
	VCGT110302	1C		●	●	●		
	VCGT110304	1C	●	●	●	●		
	VCGT160402	1C		●	●	●		
	VCGT160404	1C	●	●	●	●		
	VCGT160408	1C	●	●		●		
	VCGT110302	2C		●	●	●		
	VCGT110304	2C	●	●	●	●		
	VCGT160402	2C		●	●	●		
	VCGT160404	2C	●	●	●	●		
	VCGT160408	2C	●	●		●		
	VCGW110302	1C		●	●	●		
	VCGW110304	1C	●	●	●	●		
	VCGW160402	1C		●	●	●		
	VCGW160404	1C	●	●	●	●		
	VCGW160408	1C	●	●		●		
	VCGW110302	2C		●	●	●		
	VCGW110304	2C	●	●	●	●		
	VCGW160402	2C		●	●	●		
	VCGW160404	2C	●	●	●	●		
	VCGW160408	2C	●	●		●		
	VCGX110304R/L	FE		●		●		
	VCGX160404R/L	FE		●		●		
				●		●		

터닝
그루브
나사
밀링
인테셔널 드릴
엔드밀
솔리드 드릴
부품
색인표



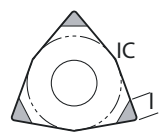

NEGATIVE with hole

WN□□

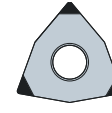

WN	0604	0804
IC	9,525	12,7
T	4,76	4,76
Ød	3,81	5,16
Holder	186	186

DESCRIPTION 형번		EDGE 코너수		PCD						
				PC100	PC150	PC200	PC300			
	WNGA060404	1C			•	•	•			
	WNGA080404	1C		•	•		•			
	WNGA080408	1C		•	•		•			
	WNGA080404	3C		•	•	•	•			
	WNGA080408	3C		•	•		•			
	WNGA080404	6C		•	•	•	•			
	WNGA080408	6C		•	•		•			

Cutting Parameters / 절삭 조건

AL	알루미늄합금 ALUMINIUM ALLOYS
NS	알루미늄합금 ALUMINIUM ALLOYS (Si≤15%)
HAL	강화알루미늄합금 AL ALLOYS AGED AND HARDENED
NB	황동 BRASS

CU	청동, 구리 BRONZE AND ELECTROLYTIC COPPER
C	흑연 GRAPHITE
STR	내열강 HARD METAL (Co≤16%)
HRSA	탄삭재 TITANIUM ALLOYS

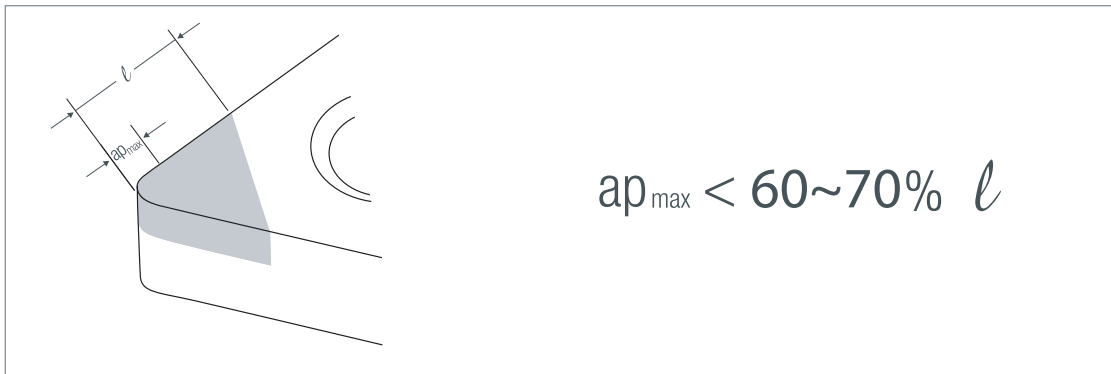

MATERIAL 피삭재	ap (mm)	fn (mm/ rev)	CUTTING CONDITION	PCD						
				PC100	PC150	PC200	PC300			
N	AL	0,10~1,00	0,08~0,25	○ ⊕ ♪		600~2500		600~2500		
		1,00~2,50	0,15~0,50	○ ⊕ ♪		600~1600		600~1600		
	NS	0,10~1,00	0,05~0,20	○ ⊕ ♪			500~1800			
		1,00~2,50	0,08~0,35	○ ⊕ ♪			500~1200			
	HAL	0,10~1,00	0,05~0,35	○ ⊕ ♪			400~1000			
		1,00~2,50	0,08~0,35	○ ⊕ ♪			400~800			
	NB	0,10~1,00	0,10~0,30	○ ⊕ ♪	400~1200	400~1200		400~1200		
		1,00~2,50	0,15~0,25	○ ⊕ ♪	400~1000	400~1000		400~1000		
	CU	0,10~1,00	0,10~0,30	○ ⊕ ♪	300~800	300~800		300~800		
		1,00~2,50	0,15~0,25	○ ⊕ ♪	300~500	300~500		300~500		
C	0,10~1,00	0,08~0,25	○ ⊕ ♪		300~800	300~800	300~800			
	1,00~2,50	0,15~0,50	○ ⊕ ♪		300~600	300~600	300~600			
H	STR	0,10~0,50	0,08~0,25	○ ♪			10~40			
S	HRSA	0,10~1,00	0,05~0,20	○ ⊕ ♪	100~200	100~200	100~220	100~200		
		1,00~2,50	0,08~0,20	○ ⊕ ♪	100~150	100~150	100~220	100~150		

- TURNING
- GROOVING
- THREADING
- MILLING
- DRILLING
- ENDMILLS
- DRILLS
- SPARE PARTS
- INDEX

터닝
그루빙
나사
밀링
인테르볼 드릴
엔드밀
슬리드 드릴
부품
색인표



P C L N R 25 25 M 12

1 2 3 4 5 6 7 8 9

1	Clamping System 클램핑 방식	2	Geometry 인서트 형상	3	Lead Angle 홀더 형상	4	Clearance Angle 인서트 여유각	
C		C	80°	A	90°	B	5°	
M		D	55°	B	75°	C	7°	
P		K	55°	D	45°	P	11°	
S		S	90°	F	90°	N	0°	
T		T	60°	G	90°			
		V	35°	J	93°			
		W	80°	K	75°			
				L	95°			
				N	63°			
5	Direction 승수	6	Shank 샹크 높이 / 폭	7	Total Length 홀더 길이	9	Edge Length 인선 길이	
L		(H)		(B)		C	06 09 12 16 19 25	
N					H	100	D	07 11 15
R					K	125	K	16
					M	150	S	09 12 15 19 25
					P	170	T	09 11 16 22
					S	250	V	11 16 22
							W	06 08

터닝
그루브
나사
임핀
인테셔널 드릴
엔드밀
슬리드 드릴
부품
색인표



S 16 K - S C L C R - 06

1	2	3	4	5	6	7	8	9																																																																																																							
1 Type of Bar 샤크 재종 <table border="1"> <tr><td>A</td><td>Steel + Coolant</td></tr> <tr><td>C</td><td>Carbide</td></tr> <tr><td>S</td><td>Steel</td></tr> <tr><td>A</td><td>스틸 + 오일홀</td></tr> <tr><td>C</td><td>초경샤크</td></tr> <tr><td>S</td><td>스틸샤크</td></tr> </table>	A	Steel + Coolant	C	Carbide	S	Steel	A	스틸 + 오일홀	C	초경샤크	S	스틸샤크	2 Shank Diameter 샤크 직경 <div style="text-align: center;"> </div>	3 Total Length 공구 길이 <table border="1"> <tr><td>E</td><td>70</td></tr> <tr><td>F</td><td>80</td></tr> <tr><td>H</td><td>100</td></tr> <tr><td>K</td><td>125</td></tr> <tr><td>M</td><td>150</td></tr> <tr><td>Q</td><td>170</td></tr> <tr><td>R</td><td>200</td></tr> <tr><td>S</td><td>250</td></tr> <tr><td>T</td><td>300</td></tr> <tr><td>U</td><td>350</td></tr> <tr><td>V</td><td>400</td></tr> </table>	E	70	F	80	H	100	K	125	M	150	Q	170	R	200	S	250	T	300	U	350	V	400	4 Clamping System 클램핑 방식 <table border="1"> <tr><td>M</td><td></td></tr> <tr><td>P</td><td></td></tr> <tr><td>S</td><td></td></tr> <tr><td>T</td><td></td></tr> </table>	M		P		S		T		5 Insert shape & size 인서트 형상 & 사이즈 <table border="1"> <tr><td>C</td><td></td><td>06 09 12 16 19 25</td></tr> <tr><td>D</td><td></td><td>07 11 15</td></tr> <tr><td>K</td><td></td><td>16</td></tr> <tr><td>S</td><td></td><td>09 12 15 19 25</td></tr> <tr><td>T</td><td></td><td>09 11 16 22</td></tr> <tr><td>V</td><td></td><td>11 16 22</td></tr> <tr><td>W</td><td></td><td>06 08</td></tr> </table>	C		06 09 12 16 19 25	D		07 11 15	K		16	S		09 12 15 19 25	T		09 11 16 22	V		11 16 22	W		06 08	6 Lead Angle 공구 형상 <table border="1"> <tr><td>A</td><td></td><td>90°</td></tr> <tr><td>F</td><td></td><td>90°</td></tr> <tr><td>J</td><td></td><td>93°</td></tr> <tr><td>K</td><td></td><td>75°</td></tr> <tr><td>L</td><td></td><td>95° 95°</td></tr> <tr><td>Q</td><td></td><td>107.5°</td></tr> <tr><td>U</td><td></td><td>93°</td></tr> <tr><td>Z</td><td></td><td>93°</td></tr> </table>	A		90°	F		90°	J		93°	K		75°	L		95° 95°	Q		107.5°	U		93°	Z		93°	7 Clearance Angle 인서트 여유각 <table border="1"> <tr><td>B</td><td></td><td>5°</td></tr> <tr><td>C</td><td></td><td>7°</td></tr> <tr><td>P</td><td></td><td>11°</td></tr> <tr><td>N</td><td></td><td>0°</td></tr> </table>	B		5°	C		7°	P		11°	N		0°	8 Direction 승수 <table border="1"> <tr><td>L</td><td></td></tr> <tr><td>R</td><td></td></tr> </table>	L		R		9
A	Steel + Coolant																																																																																																														
C	Carbide																																																																																																														
S	Steel																																																																																																														
A	스틸 + 오일홀																																																																																																														
C	초경샤크																																																																																																														
S	스틸샤크																																																																																																														
E	70																																																																																																														
F	80																																																																																																														
H	100																																																																																																														
K	125																																																																																																														
M	150																																																																																																														
Q	170																																																																																																														
R	200																																																																																																														
S	250																																																																																																														
T	300																																																																																																														
U	350																																																																																																														
V	400																																																																																																														
M																																																																																																															
P																																																																																																															
S																																																																																																															
T																																																																																																															
C		06 09 12 16 19 25																																																																																																													
D		07 11 15																																																																																																													
K		16																																																																																																													
S		09 12 15 19 25																																																																																																													
T		09 11 16 22																																																																																																													
V		11 16 22																																																																																																													
W		06 08																																																																																																													
A		90°																																																																																																													
F		90°																																																																																																													
J		93°																																																																																																													
K		75°																																																																																																													
L		95° 95°																																																																																																													
Q		107.5°																																																																																																													
U		93°																																																																																																													
Z		93°																																																																																																													
B		5°																																																																																																													
C		7°																																																																																																													
P		11°																																																																																																													
N		0°																																																																																																													
L																																																																																																															
R																																																																																																															

- TURNING
- GROOVING
- THREADING
- MILLING
- DRILLING
- ENDMILLS
- DRILLS
- SPARE PARTS
- INDEX

터닝

그루비

나사

미립

인테셔널 드릴

엔드밀

솔리드 드릴

부품

색인표

LEVER LOCK CLAMPING SYSTEM (NEGATIVE) 레버 락 클램핑 시스템 (네가티브)

Easy to use - Excellent chip ejection

P

레버락 시스템

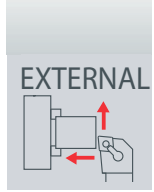

외경가공용

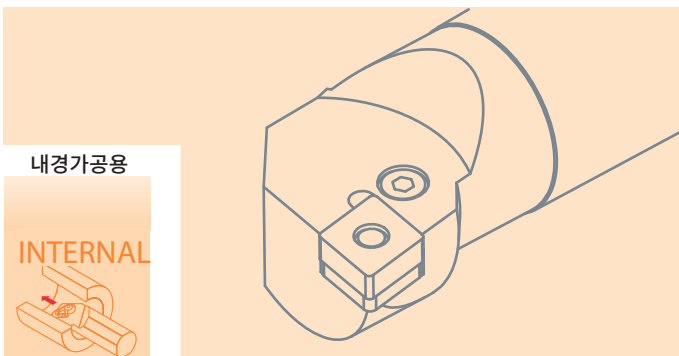
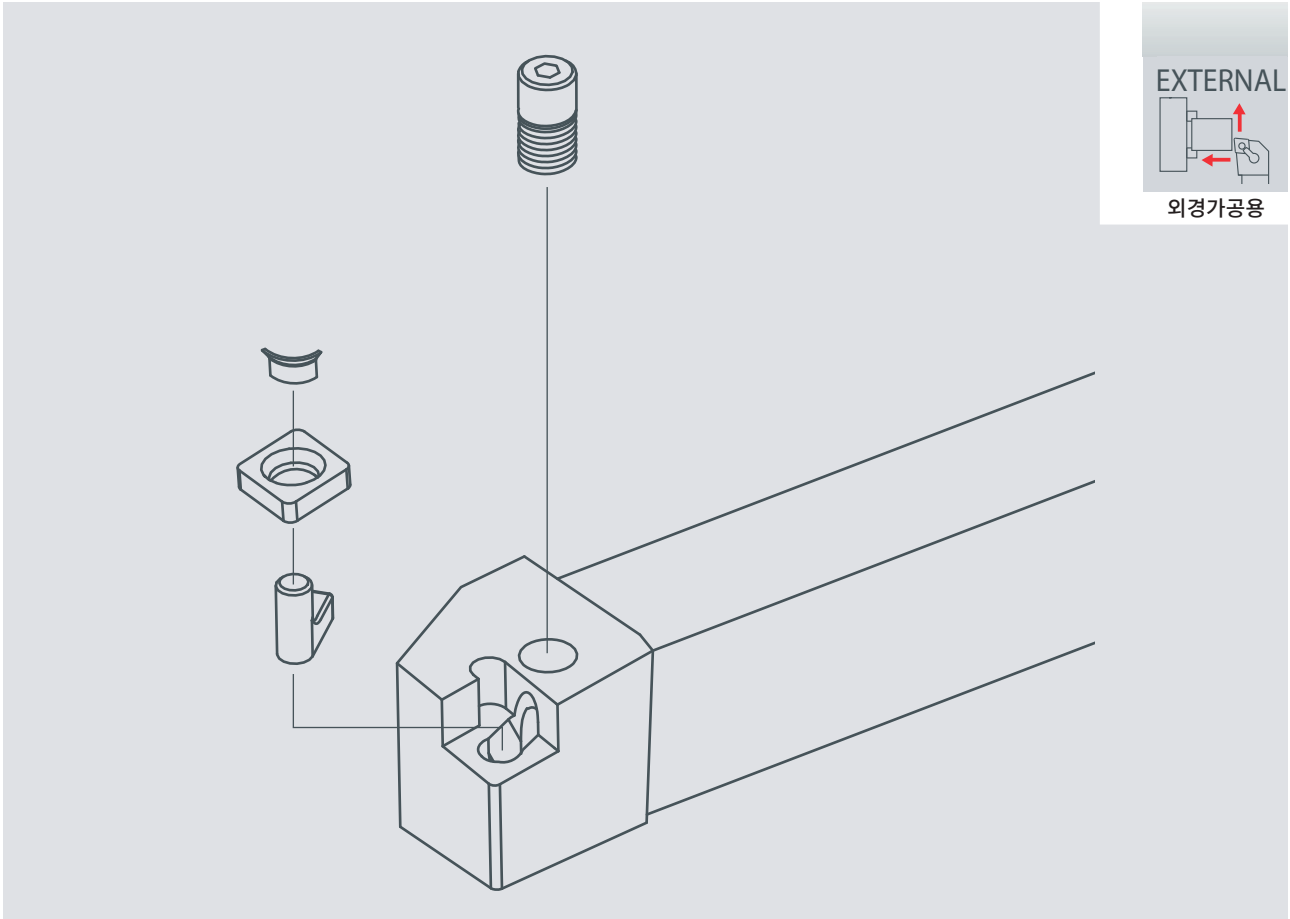

내경가공용

INTERNAL

TURNING 터닝

MULTI CLAMPING SYSTEM (NEGATIVE)

멀티 클램핑 시스템(네가티브)

High Clamping Strength - First choice for ceramic inserts

M

멀티 클램프 시스템

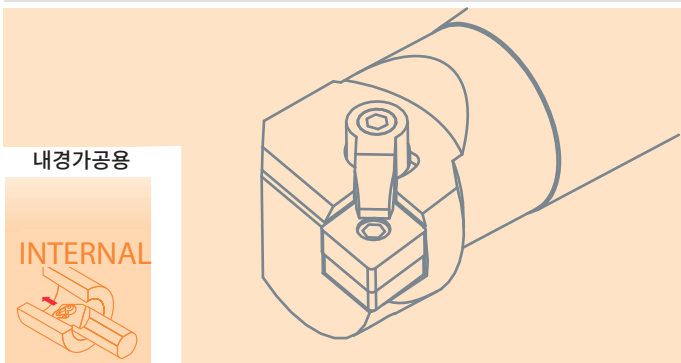
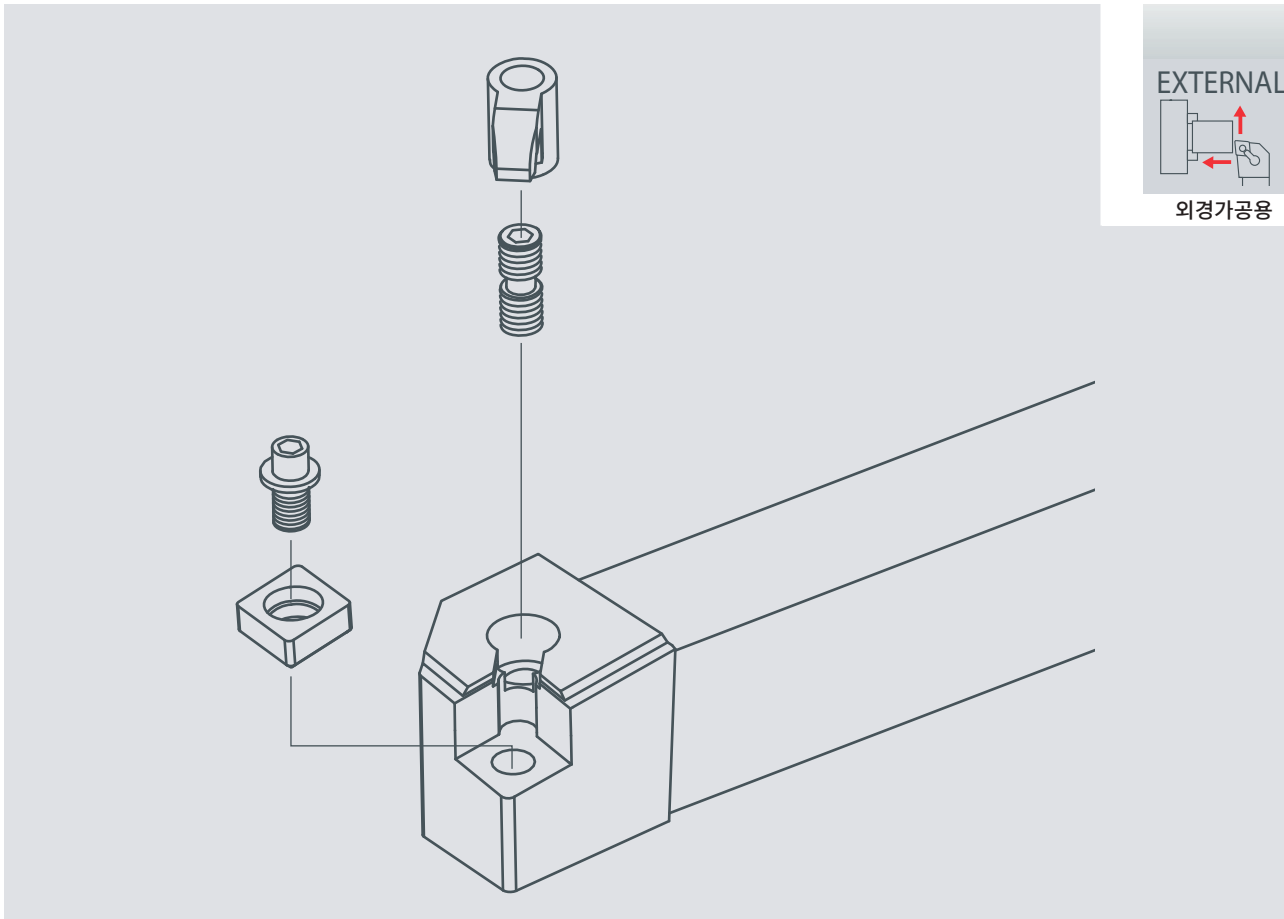
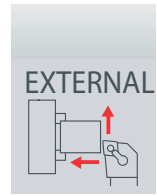

TURNING

GROOVING

THREADING

MILLING

DRILLING

ENDMILLS

DRILLS

SPARE PARTS

INDEX

DOUBLE CLAMPING SYSTEM (NEGATIVE) 더블 클램핑 시스템(네가티브)

Fast Clamping - Ideal for short chip materials



더블 클램프 시스템

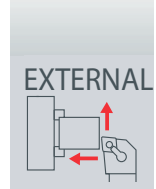

외경가공용

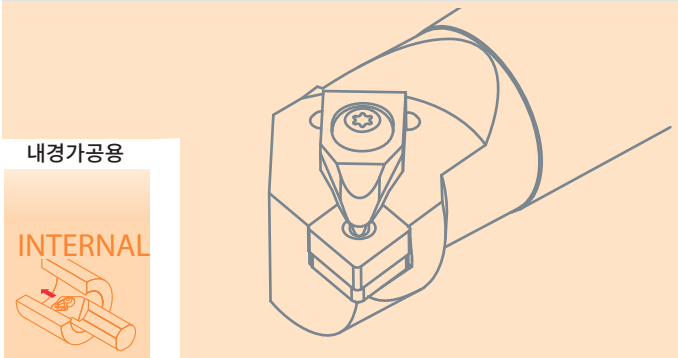
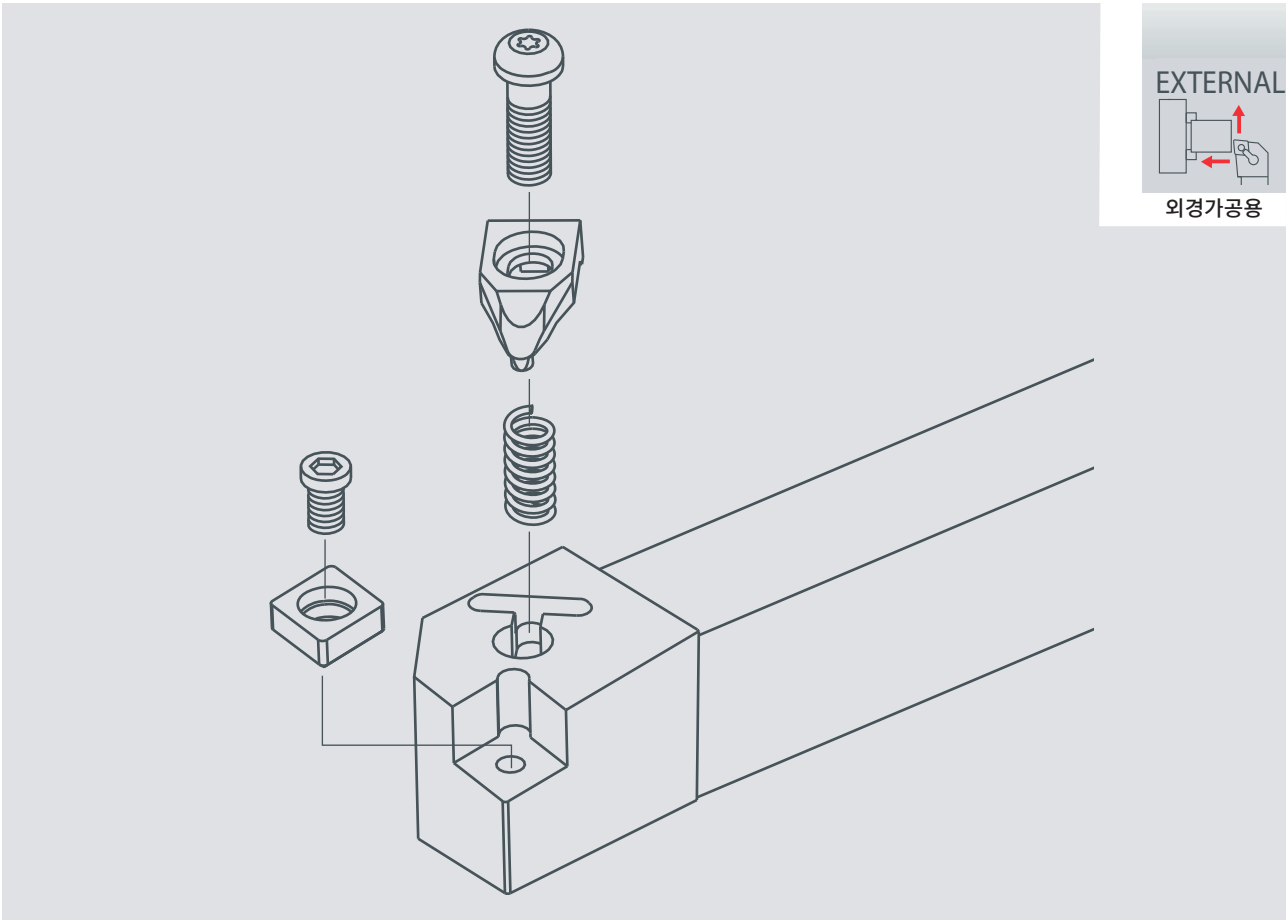

내경가공용

INTERNAL

터닝

그루브

나사

핀

인테셔널 드릴

엔드밀

슬리드 드릴

부품

색인표

TURNING

GROOVING

THREADING

MILLING

DRILLING

ENDMILLS

DRILLS

SPARE PARTS

INDEX



EXTERNAL HOLDER GUIDE / 외경홀더 가이드

- 터닝
- 그루브
- 나사
- 윤곽
- 인테서블 드릴
- 엔드밀
- 슬리드 드릴
- 부품
- 색인표

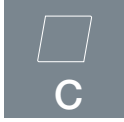

SCAC	SCLC	SCMC	PCBN	PCLN	PCMN	TCLN	TCMN	TCZN
CC□□ 120	CC□□ 121	CC□□ 122	CN□□ 125	CN□□ 126	CN□□ 127	CN□□ 128	CN□□ 129	CN□□ 130



SDHC	SDJC	SDNC	PDJN	PDNN	TDHN	TDJN	TDNN
DC□□ 133	DC□□ 134	DC□□ 135	DN□□ 142	DN□□ 143	DN□□ 143	DN□□ 144	DN□□ 145

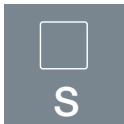

SSDC	SSSC	PSBN	PSDN	PSKN	PSSN	TSDN	TSKN	TSSN
SC□□ 154	SC□□ 155	SN□□ 157	SN□□ 158	SN□□ 159	SN□□ 160	SN□□ 160	SN□□ 161	SN□□ 161



STFC	STGC	STJC	MTEN	MTJN	TTEN	TTJN
TC□□ 163	TC□□ 164	TC□□ 165	TN□□ 170	TN□□ 171	TN□□ 171	TN□□ 172



SVHB	SVJB	SVVB	SVZB	SVHC	SVJC	TVHN	TVJN	TVVN
VB□□ 175	VB□□ 176	VB□□ 177	VB□□ 178	VC□□ 181	VC□□ 181	VN□□ 183	VN□□ 183	VN□□ 184



MWDN	MWLN	PWLN	TWLN	OTHERS	CKJN	SRDC	SRGC	SRHC
WN□□ 186	WN□□ 186	WN□□ 187	WN□□ 187		KN□□ 149	RC□□ 151	RC□□ 152	RC□□ 153



CDJN	CSDN	CSSN	CTJN	CRDC
DN□□ 142	SN□□ 156	SN□□ 157	TN□□ 170	RC□□ 150



INTERNAL HOLDER GUIDE / 내경홀더 가이드

	 CCCC 123	 CCCC 124	 CND 131	 CND 132							
	 DCCC 136	 DCCC 137	 DCCC 138	 DCCC 139	 DCCC 140	 DND 141	 DND 146	 DND 146	 DND 147	 DND 147	 DND 148
	 KND 149		 SCC 156	 SND 162	 SND 162						
	 TCC 166	 TCC 167	 TCC 168	 TCC 169	 TPC 169	 TND 172	 TND 173	 TND 173	 TND 174	 TND 174	
	 VBC 179	 VBC 179	 VBC 180	 VBC 180	 VCC 182	 VCC 182	 VND 184				
	 WCC 185	 WND 188	 WND 188	 WND 189							

TURNING

GROOVING

THREADING

MILLING

DRILLING

ENDMILLS

DRILLS

SPARE PARTS

INDEX

터닝

그라운드

나사

임베디드

인테그럴 드릴

엔드밀

솔리드 드릴

부품

색인표

SCAC

POSITIVE 7 (인서트 여유각 7도)
with Hole (스크류온 타입)

CC □ □

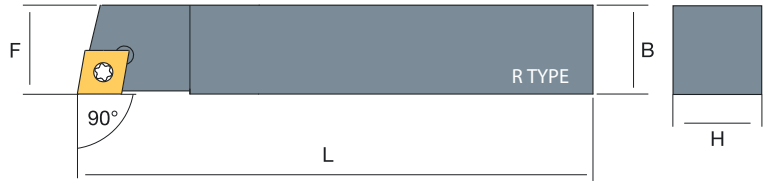

CC	DESCRIPTION 형번			STOCK 재고		DIMENSIONS 치수									
				R	L	H	B	L	F						
CC 0602	SCACR/L	0808	E06	●	●	08	08	60	10	ST-SC0257	ST-WRT08				
		1010	E06	●	●	10	10	70	16	ST-SC0257	ST-WRT08				
CC 09T3	SCACR/L	1212	F09	●	●	12	12	80	20	ST-SC3507	ST-WRT15				
		1616	K09	●	●	16	16	100	20	ST-SC3514	ST-WRT15	ST-SHCC09	ST-SC5011		
		2020	M09	●	●	20	20	125	25	ST-SC3514	ST-WRT15	ST-SHCC09	ST-SC5011		
		2525	H09	●	●	25	25	150	32	ST-SC3514	ST-WRT15	ST-SHCC09	ST-SC5011		
CC 1204	SCACR/L	2020	K12	●	●	20	20	125	25	ST-SC0416	ST-WRT15	ST-SHCC12	ST-SC6011		
		2525	M12	●	●	25	25	150	32	ST-SC0416	ST-WRT15	ST-SHCC12	ST-SC6011		

적용인서트

22

PCBN

79

다이아몬드



99

SCLC

POSITIVE 7(인서트 여유각 7도)
 with Hole (스크류온 타입)

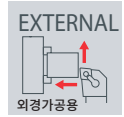
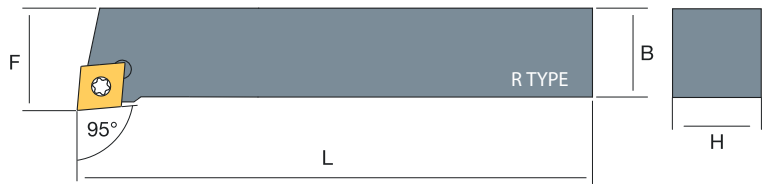
CC□□



CC	DESCRIPTION 형번			STOCK 재고		DIMENSIONS 치수												
				R	L	H	B	L	F									
CC 0602	SCLCR/L	0808	E06	●	●	8	8	70	10	ST-SC0257	ST-WRT08							
		1010	E06	●	●	10	10	70	12	ST-SC0257	ST-WRT08							
		1212	F06	●	●	12	12	80	16	ST-SC0257	ST-WRT08							
CC 09T3	SCLCR/L	1212	F09	●	●	12	12	80	16	ST-SC3511	ST-WRT15							
		1616	H09	●	●	16	16	100	20	ST-SC3514	ST-WRT15	ST-SHCC09	ST-SC5011					
		2020	K09	●	●	20	20	125	25	ST-SC3514	ST-WRT15	ST-SHCC09	ST-SC5011					
		2525	M09	●	●	25	25	150	32	ST-SC3514	ST-WRT15	ST-SHCC09	ST-SC5011					
CC 1204	SCLCR/L	2020	K12	●	●	20	20	125	25	ST-SC0416	ST-WRT15	ST-SHCC12	ST-SC6011					
		2525	M12	●	●	25	25	150	32	ST-SC0416	ST-WRT15	ST-SHCC12	ST-SC6011					

TURNING

GROOVING

THREADING

MILLING

DRILLING

ENDMILLS

DRILLS

SPARE PARTS

INDEX

carbide

22

PCBN

79

diamond

99

터닝

그라운드

나사

임베디드

인테그럴 드릴

엔드밀

솔리드 드릴

부품

색인표

SCMCN

POSITIVE 7 (인서트 여유각 7도)
with Hole (스크류온 타입)

CC

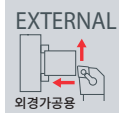
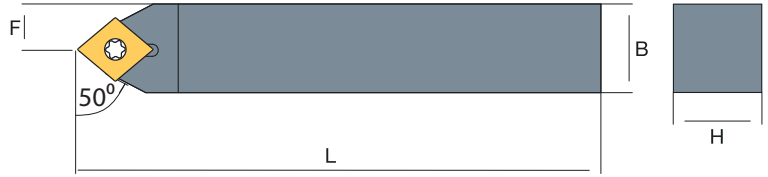

CC	DESCRIPTION 형번			STOCK 재고	DIMENSIONS 치수									
					H	B	L	F						
CC 0602	SCMCN	0808	E06	●	8	8	70	04	ST-SC0257	ST-WRT08				
		1010	E06	●	10	10	70	05	ST-SC0257	ST-WRT08				
CC 09T3	SCMCN	1212	F09	●	12	12	80	06	ST-SC3511	ST-WRT15				
		1616	H09	●	16	16	100	08	ST-SC3514	ST-WRT15	ST-SHCC09	ST-SC5011		
		2020	K09	●	20	20	125	10	ST-SC3514	ST-WRT15	ST-SHCC09	ST-SC5011		
		2525	M09	●	25	25	150	12.5	ST-SC3514	ST-WRT15	ST-SHCC09	ST-SC5011		
CC 1204	SCMCN	2020	K12	●	20	20	125	10	ST-SC0416	ST-WRT15	ST-SHCC12	ST-SC6011		
		2525	M12	●	25	25	150	12.5	ST-SC0416	ST-WRT15	ST-SHCC12	ST-SC6011		

적용인서트

22

PCBN

79

다이아몬드

99

^SSCLC

POSITIVE 7(인서트 여유각 7도)
with Hole (스크류온 타입)

CC □ □

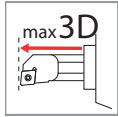
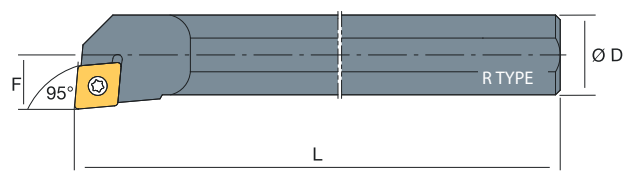
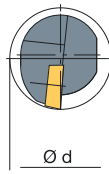

CC	DESCRIPTION 형번			STOCK 재고		DIMENSIONS 치수									
				R	L	ØD	Ød	L	F						
CC 0602	S06H	SCLCR/L	06	●	●	06	>08	100	4.5	ST-SC0257	ST-WRT08				
	S08H		06	●	●	08	>11	100	06	ST-SC0257	ST-WRT08				
	S10M		06	●	●	10	>13	125	07	ST-SC0257	ST-WRT08				
	S10M		06	●	●	10	>13	150	07	ST-SC0257	ST-WRT08				
	S12M		06	●	●	12	>16	125	09	ST-SC0257	ST-WRT08				
	S16M		06	●	●	16	>13	150	09	ST-SC0257	ST-WRT08				
CC 09T3	S12K	SCLCR/L	09	●	●	12	>16	125	09	ST-SC3511	ST-WRT15				
	S16P		09	●	●	16	>21	170	11	ST-SC3511	ST-WRT15				
	S20R		09	●	●	20	>25	200	13	ST-SC3511	ST-WRT15				
	S25S		09	●	●	25	>32	250	17	ST-SC3511	ST-WRT15				
	S32T		09	●	●	32	>40	300	22	ST-SC3514	ST-WRT15	ST-SHCC09	ST-SC5011		
	S32T	SCLCR/L	12	●	●	32	>40	300	22	ST-SC0416	ST-WRT15	ST-SHCC12	ST-SC6011		
	S40T		12	●	●	40	>50	350	27	ST-SC0416	ST-WRT15	ST-SHCC12	ST-SC6011		

TURNING

GROOVING

THREADING

MILLING

DRILLING

ENDMILLS

DRILLS

SPARE PARTS

INDEX

carbide

22

PCBN

79

diamond

99

터닝

그라운드

나사

밀링

인테셔널 드릴

엔드밀

슬리드 드릴

부품

색인표

C SCLC

POSITIVE 7 (인서트 여유각 7도)
with Hole (스크류온 타입)

CC□□

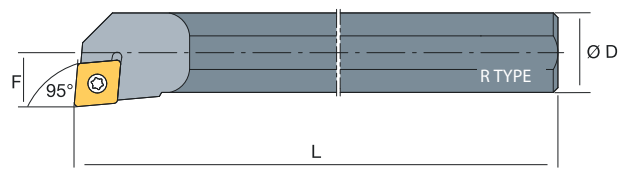
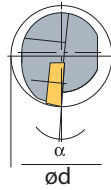
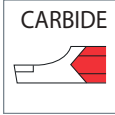
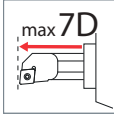

CC	DESCRIPTION 형번			STOCK 재고		DIMENSIONS 치수												
				R	L	ØD	Ød	L	F									
CC 0301	C04G	SCLCR/L	03	●	●	04	5	90	3.8		ST-SC01635	ST-WRT06						
	C05H		03	●	●	05	6	100	4.4		ST-SC01635	ST-WRT06						
CC 0401	C06J	SCLCR/L	04	●	●	06	7	110	5.4		ST-SC0235	ST-WRT06						
CC 0602	C08L	SCLCR/L	06	●	●	08	10	140	07		ST-SC02545	ST-WRT08						
	C10N		06	●	●	10	12	160	09		ST-SC02545	ST-WRT08						
	C12Q		06	●	●	12	14	180	11		ST-SC02545	ST-WRT08						
CC 09T3	C12Q	SCLCR/L	09	●	●	12	16	180	11		ST-SC0407	ST-WRT15						
	C16X		09	●	●	16	18	220	15		ST-SC0407	ST-WRT15						
	C20S		09	●	●	20	22	250	19		ST-SC0407	ST-WRT15						
	C25T		09	●	●	25	27	300	24		ST-SC0407	ST-WRT15						

적용인서트

22

PCBN

79

다이아몬드

99

PCBN

LEVER LOCK (레버락 타입) **CN** □□

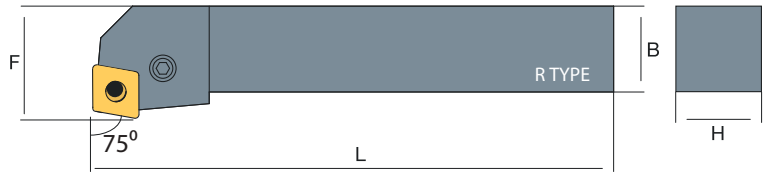

CN	DESCRIPTION 형번			STOCK 재고		DIMENSIONS 치수								
				R	L	H	B	L	F					
CN 1204	PCBNR/L	2020	K12	●	●	20	20	125	17.5	ST-SHCN12	ST-SPR001	ST-LV001	ST-SC820	ST-WR0030
		2525	M12	●	●	25	25	150	22.5	ST-SHCN12	ST-SPR001	ST-LV001	ST-SC820	ST-WR0030
		3232	P12	●	●	32	32	170	27.5	ST-SHCN12	ST-SPR001	ST-LV001	ST-SC820	ST-WR0030
CN 1606	PCBNR/L	2525	M16	●	●	25	25	150	22	ST-SHCN16	ST-SPR002	ST-LV002	ST-SC822	ST-WR0050
		3232	P16	●	●	32	32	170	27	ST-SHCN16	ST-SPR002	ST-LV002	ST-SC822	ST-WR0050
CN 1906	PCBNR/L	3232	P19	●	●	32	32	170	27	ST-SHCN19	ST-SPR003	ST-LV003	ST-SC1025	ST-WR0060
		4040	S19	●	●	40	40	250	37	ST-SHCN19	ST-SPR003	ST-LV003	ST-SC1025	ST-WR0060

TURNING

GROOVING

THREADING

MILLING

DRILLING

ENDMILLS

DRILLS

SPARE PARTS

INDEX

carbide

25

PCBN

80

diamond

100

터닝

그라운드

나사

임핀

인테셔널 드릴

엔드밀

솔리드 드릴

부품

색인표

PCLN

LEVER LOCK (레버락 타입) **CN** □□

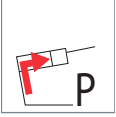

CN	DESCRIPTION 형번			STOCK 재고		DIMENSIONS 치수								
				R	L	H	B	L	F					
CN 1204	PCLNR/L	2020	K12	●	●	20	20	125	25	ST-SHCN12	ST-SPR001	ST-LV001	ST-SC820	ST-WR0030
		2525	M12	●	●	25	25	150	32	ST-SHCN12	ST-SPR001	ST-LV001	ST-SC820	ST-WR0030
		3232	P12	●	●	32	32	170	40	ST-SHCN12	ST-SPR001	ST-LV001	ST-SC820	ST-WR0030
CN 1606	PCLNR/L	2525	M16	●	●	25	25	150	32	ST-SHCN16	ST-SPR002	ST-LV002	ST-SC822	ST-WR0050
		3232	P16	●	●	32	32	170	40	ST-SHCN16	ST-SPR002	ST-LV002	ST-SC822	ST-WR0050
CN 1906	PCLNR/L	3232	P19	●	●	32	32	170	40	ST-SHCN19	ST-SPR003	ST-LV003	ST-SC1025	ST-WR0060
		4040	S19	●	●	40	40	250	50	ST-SHCN19	ST-SPR003	ST-LV003	ST-SC1025	ST-WR0060

적용인서트 ▶ 25





PCBN ▶ 80

다이아몬드 ▶ 100

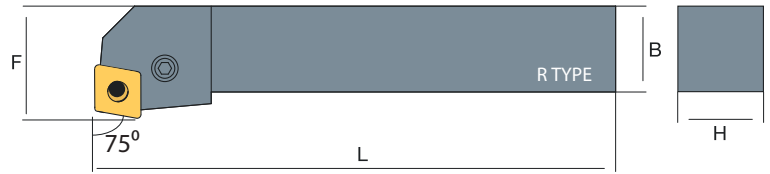
PCMNN

LEVER LOCK (레버락 타입) **CN** □ □



CN	DESCRIPTION			STOCK 재고	DIMENSIONS 치수								
	PCMNN	형번			H	B	L	F					
CN 1204	PCMNN	2020	K12	●	20	20	125	17.5	ST-SHCN12	ST-SPR001	ST-LV001	ST-SC820	ST-WR0030
		2525	M12	●	25	25	150	22.5	ST-SHCN12	ST-SPR001	ST-LV001	ST-SC820	ST-WR0030
		3232	P12	●	32	32	170	27.5	ST-SHCN12	ST-SPR001	ST-LV001	ST-SC820	ST-WR0030
CN 1606	PCMNN	2525	M16	●	25	25	150	22	ST-SHCN16	ST-SPR002	ST-LV002	ST-SC822	ST-WR0050
		3232	P16	●	32	32	170	27	ST-SHCN16	ST-SPR002	ST-LV002	ST-SC822	ST-WR0050
CN 1906	PCMNN	3232	P19	●	32	32	170	27	ST-SHCN19	ST-SPR003	ST-LV003	ST-SC1025	ST-WR0060
		4040	S19	●	40	40	250	37	ST-SHCN19	ST-SPR003	ST-LV003	ST-SC1025	ST-WR0060

TURNING

GROOVING

THREADING

MILLING

DRILLING

ENDMILLS

DRILLS

SPARE PARTS

INDEX

carbide ▶ 25

PCBN ▶ 80

diamond ▶ 100

터닝

그라운드

나사

임핀

인테셔널 드릴

엔드밀

솔리드 드릴

부품

색인표

TCLN

DOUBLE CLAMP
(더블클램프 타입)

CN □□

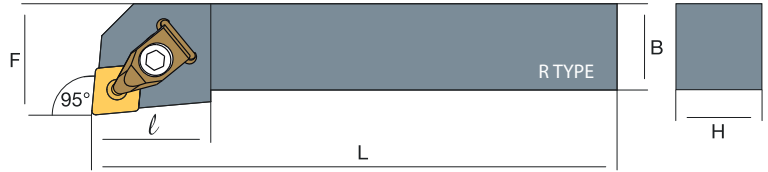
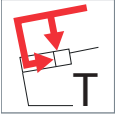

CN	DESCRIPTION 형번			STOCK 재고		DIMENSIONS 치수									
				R	L	H	B	L	F						
CN 1204	TCLNR/L	2020	K12	●	●	20	20	125	25	ST-SHCN12	ST-SC0410	ST-CS001	ST-SPR04	ST-SC630	ST-WR0030
		2525	M12	●	●	25	25	150	32	ST-SHCN12	ST-SC0410	ST-CS001	ST-SPR04	ST-SC630	ST-WR0030
		3232	P12	●	●	32	32	170	40	ST-SHCN12	ST-SC0410	ST-CS001	ST-SPR04	ST-SC630	ST-WR0030
		4040	S12	●	●	40	40	250	50	ST-SHCN12	ST-SC0410	ST-CS001	ST-SPR04	ST-SC630	ST-WR0030
CN 1606	TCLNR/L	2525	M16	●	●	25	25	150	32	ST-SHCN16	ST-SC6169	ST-CS003	-	ST-SC6307	ST-WR0040
		3232	P16	●	●	32	32	170	40	ST-SHCN16	ST-SC6169	ST-CS003	-	ST-SC6307	ST-WR0040
		4040	S16	●	●	40	40	250	50	ST-SHCN16	ST-SC6169	ST-CS003	-	ST-SC6307	ST-WR0040
CN 1906	TCLNR/L	3232	P19	●	●	32	32	170	40	ST-SHCN19	ST-SC6611	ST-CS004	-	ST-SC830	ST-WR0040
		4040	S19	●	●	40	40	250	50	ST-SHCN19	ST-SC6611	ST-CS004	-	ST-SC830	ST-WR0040

적용인서트

25

PCBN

80

다이아몬드

100

TCMNN

DOUBLE CLAMP
(더블클램프 타입)

CN □□

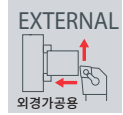
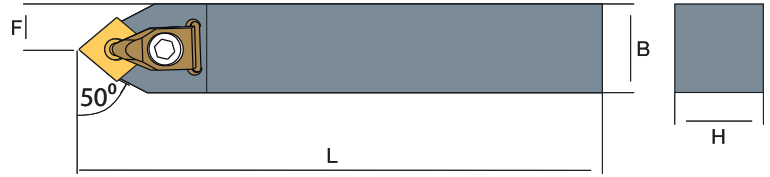
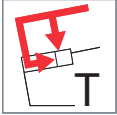

CN	DESCRIPTION 형번			STOCK 재고	DIMENSIONS 치수									
	TCMNN	형번	STOCK		H	B	L	F	ST-SHCN	ST-SC	ST-CS	ST-SPR	ST-SC	ST-WR
CN 1204	TCMNN	1616	H12	●	16	16	100	08	ST-SHCN12	ST-SC0410	ST-CS001	ST-SPR04	ST-SC630	ST-WR0030
		2020	K12	●	20	20	125	10	ST-SHCN12	ST-SC0410	ST-CS001	ST-SPR04	ST-SC630	ST-WR0030
		2525	M12	●	25	25	150	12.5	ST-SHCN12	ST-SC0410	ST-CS001	ST-SPR04	ST-SC630	ST-WR0030
		3232	P12	●	32	32	170	16	ST-SHCN12	ST-SC0410	ST-CS001	ST-SPR04	ST-SC630	ST-WR0030
CN 1606	TCMNN	2525	M16	●	25	25	150	12.5	ST-SHCN16	ST-SC6169	ST-CS003	-	ST-SC6307	ST-WR0040
		3232	P16	●	32	32	170	16	ST-SHCN16	ST-SC6169	ST-CS003	-	ST-SC6307	ST-WR0040
		4040	S16	●	40	40	250	20	ST-SHCN16	ST-SC6169	ST-CS003	-	ST-SC6307	ST-WR0040
CN 1906	TCMNN	3232	P19	●	32	32	170	16	ST-SHCN19	ST-SC6611	ST-CS004	-	ST-SC830	ST-WR0040
		4040	S19	●	40	40	250	20	ST-SHCN19	ST-SC6611	ST-CS004	-	ST-SC830	ST-WR0040

carbide ▶ 25

PCBN ▶ 80

diamond ▶ 100

- TURNING
- GROOVING
- THREADING
- MILLING
- DRILLING
- ENDMILLS
- DRILLS
- SPARE PARTS
- INDEX

터닝

그라운드

나사

임핀

인테셔널 드릴

엔드밀

솔리드 드릴

부품

색인표

TCZNN

DOUBLE CLAMP
(더블클램프 타입)

CN □□

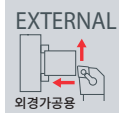
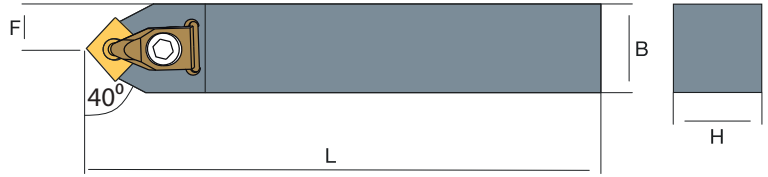
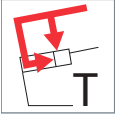

CN	DESCRIPTION 형번			STOCK 재고	DIMENSIONS 치수									
	TCZNN	형번	형번		H	B	L	F	SHCN	SC	CS	SPR	S	WR
CN 1204	TCZNN	1616	H12	●	16	16	100	08	ST-SHCN12	ST-SC0410	ST-CS001	ST-SPR04	ST-SC630	ST-WR0030
		2020	K12	●	20	20	125	10	ST-SHCN12	ST-SC0410	ST-CS001	ST-SPR04	ST-SC630	ST-WR0030
		2525	M12	●	25	25	150	12.5	ST-SHCN12	ST-SC0410	ST-CS001	ST-SPR04	ST-SC630	ST-WR0030
		3232	P12	●	32	32	170	16	ST-SHCN12	ST-SC0410	ST-CS001	ST-SPR04	ST-SC630	ST-WR0030
CN 1606	TCZNN	2525	M16	●	25	25	150	12.5	ST-SHCN16	ST-SC6169	ST-CS003	-	ST-SC6307	ST-WR0040
		3232	P16	●	32	32	170	16	ST-SHCN16	ST-SC6169	ST-CS003	-	ST-SC6307	ST-WR0040
		4040	S16	●	40	40	250	20	ST-SHCN16	ST-SC6169	ST-CS003	-	ST-SC6307	ST-WR0040
CN 1906	TCZNN	3232	P19	●	32	32	170	16	ST-SHCN19	ST-SC6611	ST-CS004	-	ST-SC830	ST-WR0040
		4040	S19	●	40	40	250	20	ST-SHCN19	ST-SC6611	ST-CS004	-	ST-SC830	ST-WR0040

적용인서트

25

PCBN

80

다이아몬드

100

S PCLN

LEVER LOCK (레버락 타입) **CN** □□

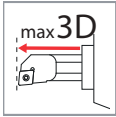
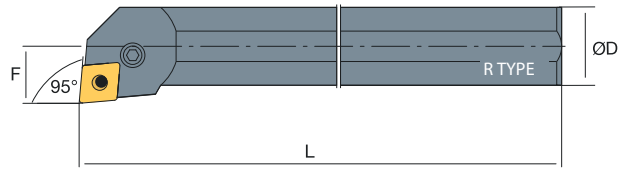
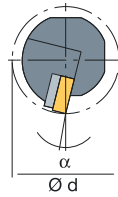

CN	DESCRIPTION 형번		STOCK 재고		DIMENSIONS 치수				ST-SHCN	ST-SPR	ST-LV	ST-SC	ST-WR
			R	L	ØD	Ød	L	F					
CN 1204	S25S	PCLNR/L	12	● ●	25	32	250	17	ST-SHCN12	ST-SPR001	ST-LV001	ST-SC820	ST-WR0030
	S32T		12	● ●	32	40	300	22	ST-SHCN12	ST-SPR001	ST-LV001	ST-SC820	ST-WR0030
	S40U		12	● ●	40	50	350	27	ST-SHCN12	ST-SPR001	ST-LV001	ST-SC820	ST-WR0030
CN 1606	S32T	PCLNR/L	16	● ●	32	40	300	22	ST-SHCN16	ST-SPR002	ST-LV002	ST-SC822	ST-WR0050
	S40U		16	● ●	40	50	350	27	ST-SHCN16	ST-SPR002	ST-LV002	ST-SC822	ST-WR0050
	S50V		16	● ●	50	63	400	35	ST-SHCN16	ST-SPR002	ST-LV002	ST-SC822	ST-WR0050
CN 1906	S40U	PCLNR/L	19	● ●	40	50	350	27	ST-SHCN19	ST-SPR003	ST-LV003	ST-SC1025	ST-WR0060
	S50V		19	● ●	50	63	400	35	ST-SHCN19	ST-SPR003	ST-LV003	ST-SC1025	ST-WR0060

- TURNING
- GROOVING
- THREADING
- MILLING
- DRILLING
- ENDMILLS
- DRILLS
- SPARE PARTS
- INDEX

carbide ▶ 25

PCBN ▶ 80

diamond ▶ 100

터닝

그라운드

나사

임핀

인테셔널 드릴

엔드밀

솔리드 드릴

부품

색인표

STCLN

DOUBLE CLAMP
(더블클램프 타입)

CN □□

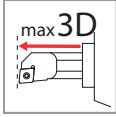
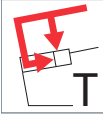
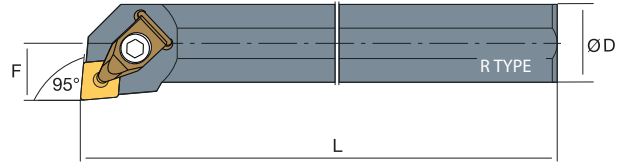
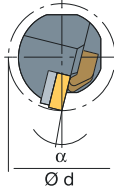

CN	DESCRIPTION 형번		STOCK 재고		DIMENSIONS 치수				←		← ← ←				
			R	L	ØD	Ød	L	F							
CN 1204	S20R	TCLNR/L	12	●	●	20	25	170	13			ST-CS001	-	ST-SC630	ST-WR0030
	S25S		12	●	●	25	32	250	17	ST-SHCN12	ST-SC0410	ST-CS001	ST-SPR04	ST-SC630	ST-WR0030
	S32T		12	●	●	32	40	300	22	ST-SHCN12	ST-SC0410	ST-CS001	ST-SPR04	ST-SC630	ST-WR0030
	S40U		12	●	●	40	50	350	27	ST-SHCN12	ST-SC0410	ST-CS001	ST-SPR04	ST-SC630	ST-WR0030
	S50V		12	●	●	50	63	400	35	ST-SHCN12	ST-SC0410	ST-CS001	ST-SPR04	ST-SC630	ST-WR0030
CN 1606	S32T	TCLNR/L	16	●	●	32	40	300	22	ST-SHCN16	ST-SC6169	ST-CS003	-	ST-SC6307	ST-WR0030
	S40U		16	●	●	40	50	350	27	ST-SHCN16	ST-SC6169	ST-CS003	-	ST-SC6307	ST-WR0030
	S50V		16	●	●	50	63	400	35	ST-SHCN16	ST-SC6169	ST-CS003	-	ST-SC6307	ST-WR0030
CN 1906	S50V	TCLNR/L	19	●	●	50	63	400	35	ST-SHCN19	ST-SC6611	ST-CS004	-	ST-SC830	ST-WR0040

적용인서트

25

PCBN

80

다이아몬드

100

SDHC

POSITIVE 7(인서트 여유각 7도) DC□□
 with Hole (스크류온 타입)

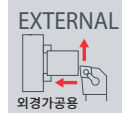
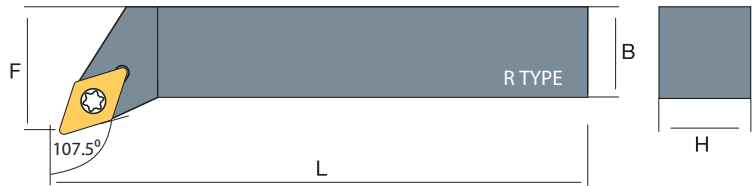

DC	DESCRIPTION 형번			STOCK 재고		DIMENSIONS 치수									
				R	L	H	B	L	F						
DC 0702	SDHCR/L	0808	E07	●	●	08	08	70	10	ST-SC0257	ST-WRT08	-	-		
		1010	E07	●	●	10	10	70	12	ST-SC0257	ST-WRT08	-	-		
		1212	F07	●	●	12	12	80	16	ST-SC0257	ST-WRT08	-	-		
		1616	H07	●	●	16	16	100	20	ST-SC0257	ST-WRT15	-	-		
DC 11T3	SDHCR/L	1616	H11	●	●	16	16	100	20	ST-SC3514	ST-WRT15	ST-SHDC11	ST-SC5011		
		2020	K11	●	●	20	20	125	25	ST-SC3514	ST-WRT15	ST-SHDC11	ST-SC5011		
		2525	M11	●	●	25	25	150	32	ST-SC3514	ST-WRT15	ST-SHDC11	ST-SC5011		
		3232	P11	●	●	32	32	170	40	ST-SC0416	ST-WRT15	ST-SHDC11	ST-SC5011		

carbide ▶ 30

PCBN ▶ 81

diamond ▶ 101

- TURNING
- GROOVING
- THREADING
- MILLING
- DRILLING
- ENDMILLS
- DRILLS
- SPARE PARTS
- INDEX

터닝

그라운드

나사

원형

인테그럴 드릴

엔드밀

슬리드 드릴

부품

색인표

SDJC

POSITIVE 7(인서트 여유각 7도) with Hole (스크류온 타입) **DC**□□

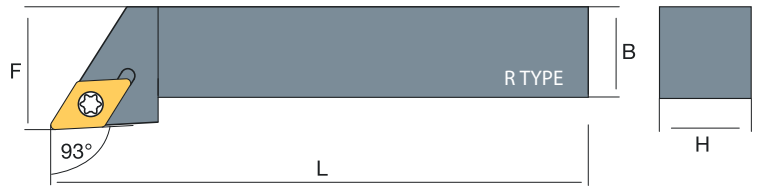

DC	DESCRIPTION 형번			STOCK 재고		DIMENSIONS 치수				ST-SC0257	ST-WRT08	-	-			
				R	L	H	B	L	F							α
DC 07	SDJCR/L	0808	E07	●	●	08	08	70	10							
		1010	E07	●	●	10	10	70	12							
		1212	F07	●	●	12	12	80	16							
		1616	H07	●	●	16	16	100	20							
DC 11	SDJCR/L	1212	F11	●	●	12	12	80	16			ST-SHDC11	ST-SC5011			
		1616	H11	●	●	16	16	100	20			ST-SHDC11	ST-SC5011			
		2020	K11	●	●	20	20	125	25			ST-SHDC11	ST-SC5011			
		2525	M11	●	●	25	25	150	32			ST-SHDC11	ST-SC5011			
		3232	P11	●	●	32	32	170	40			ST-SHDC11	ST-SC5011			

적용인서트 ▶ 30



PCBN ▶ 81

다이아몬드 ▶ 101

SDNCN

POSITIVE 7(인서트 여유각 7도) **DC**□□□
 with Hole (스크류온 타입)



DC	DESCRIPTION			STOCK 재고	DIMENSIONS 치수									
	형번				H	B	L	F						
DC 07	SDNCN	0808	E07	●	8	8	70	4	ST-SC0257	ST-WRT08	-	-		
		1010	E07	●	10	10	70	5	ST-SC0257	ST-WRT08	-	-		
		1212	F07	●	12	12	80	6	ST-SC0257	ST-WRT08	-	-		
		1616	H07	●	16	16	100	8	ST-SC0257	ST-WRT08	-	-		
DC 11	SDNCN	1212	F11	●	12	12	80	6	ST-SC3514	ST-WRT15	ST-SHDC11	ST-SC5011		
		1616	H11	●	16	16	100	8	ST-SC3514	ST-WRT15	ST-SHDC11	ST-SC5011		
		2020	K11	●	20	20	125	10	ST-SC3514	ST-WRT15	ST-SHDC11	ST-SC5011		
		2525	M11	●	25	25	150	12.5	ST-SC3514	ST-WRT15	ST-SHDC11	ST-SC5011		
		3232	P11	●	32	32	170	16	ST-SC3514	ST-WRT15	ST-SHDC11	ST-SC5011		

carbide ▶ 30

PCBN ▶ 81

diamond ▶ 101



TURNING

GROOVING

THREADING

MILLING

DRILLING

ENDMILLS

DRILLS

SPARE PARTS

INDEX

^sSDPC

POSITIVE 7(인서트 여유각 7도)
with Hole (스크류온 타입)

DC□□

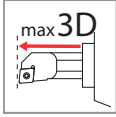
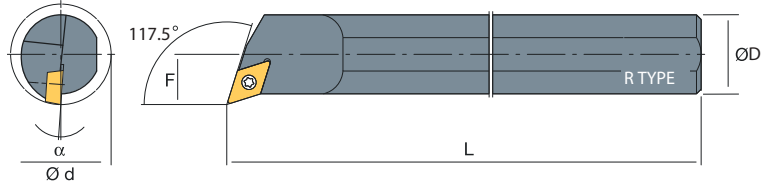

DC	DESCRIPTION 형번		STOCK 재고		DIMENSIONS 치수				←		←				
			R	L	ØD	Ød	L	F							
DC 0702	S10K	SDPCR/L	07	●	●	10	>13	125	07						
	S12K		07	●	●	12	>16	125	09	ST-SC0257	ST-WRT08	-	-		
DC 11T3	S16P	SDPCR/L	11	●	●	16	>21	170	11						
	S20R		11	●	●	20	>25	200	13	ST-SC3511	ST-WRT15	-	-		
	S25S		11	●	●	25	>32	250	17	ST-SC3511	ST-WRT15	-	-		
	S32T		11	●	●	32	>40	300	22	ST-SC3514	ST-WRT15	ST-SHDC11	ST-SC5011		
	S40T		11	●	●	40	>50	350	27	ST-SC3514	ST-WRT15	ST-SHDC11	ST-SC5011		

적용인서트 ▶ 30

PCBN ▶ 81

다이아몬드 ▶ 101

SDQC

POSITIVE 7(인서트 여유각 7도)
with Hole (스크류온 타입)

DC

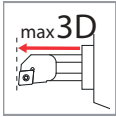
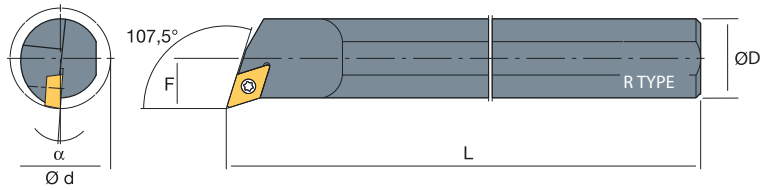

DC	DESCRIPTION 형번			STOCK 재고		DIMENSIONS 치수				←		←					
				R	L	ØD	Ød	L	F								
DC 0702	S10K	SDQCR/L	07	●	●	10	>13	125	07	ST-SC0257	ST-WRT08						
	S10M		07	●	●	16	>13	150	07	ST-SC0257	ST-WRT08						
	S12K		07	●	●	12	>16	125	09	ST-SC0257	ST-WRT08						
	S12M		07	●	●	16	>16	150	09	ST-SC0257	ST-WRT08						
	S16P		07	●	●	16	>21	170	11	ST-SC0257	ST-WRT08						
DC 11T3	S16P	SDQCR/L	11	●	●	16	>21	170	11	ST-SC3511	ST-WRT15						
	S20R		11	●	●	20	>25	200	13	ST-SC3511	ST-WRT15						
	S25S		11	●	●	25	>32	250	17	ST-SC3511	ST-WRT15						
	S32T		11	●	●	32	>40	300	22	ST-SC3514	ST-WRT15	ST-SHDC11	ST-SC5011				
	S40T		11	●	●	40	>50	350	27	ST-SC3514	ST-WRT15	ST-SHDC11	ST-SC5011				

TURNING

GROOVING

THREADING

MILLING

DRILLING

ENDMILLS

DRILLS

SPARE PARTS

INDEX

carbide

30

PCBN

81

diamond

101

^sSDUC

POSITIVE 7(인서트 여유각 7도)
with Hole (스크류온 타입)

DC□□

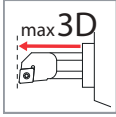
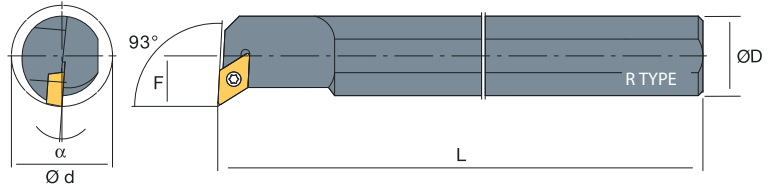

DC	DESCRIPTION 형번		STOCK 재고	DIMENSIONS 치수											
				R	L	ØD	Ød	L	F						
DC 0702	S10K	SDUCR/L	07	●	●	10	>13	125	07			ST-SC0257	ST-WRT08		
	S10M		07	●	●	16	>13	150	07			ST-SC0257	ST-WRT08		
	S12K		07	●	●	12	>16	125	09			ST-SC0257	ST-WRT08		
	S12M		07	●	●	16	>16	150	09			ST-SC0257	ST-WRT08		
	S16P		07	●	●	16	>21	170	11			ST-SC0257	ST-WRT08		
DC 11T3	S16P	SDUCR/L	11	●	●	16	>21	170	11			ST-SC3511	ST-WRT15		
	S20R		11	●	●	20	>25	200	13			ST-SC3511	ST-WRT15		
	S25S		11	●	●	25	>32	250	17			ST-SC3511	ST-WRT15		
	S32T		11	●	●	32	>40	300	22			ST-SC3514	ST-WRT15	ST-SHDC11	ST-SC5011
	S40T		11	●	●	40	>50	350	27			ST-SC3514	ST-WRT15	ST-SHDC11	ST-SC5011

적용인서트 ▶ 30

PCBN ▶ 81

다이아몬드 ▶ 101

^sSD-C

POSITIVE 7(인서트 여유각 7도)
with Hole (스크류온 타입)

DC □ □

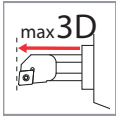
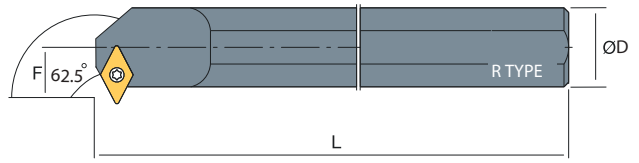
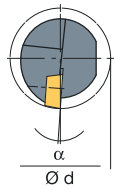

DC	DESCRIPTION 형번			STOCK 재고		DIMENSIONS 치수				←		←			
				R	L	ØD	Ød	L	F						
DC 0702	S10K	SD-CR/L	07	●	●	10	>17	125	09	ST-SC0257	ST-WRT08	-	-		
	S16M		07	●	●	16	>17	150	09	ST-SC0257	ST-WRT08	-	-		
DC 11T3	S16P	SD-CR/L	11	●	●	16	>21	170	11	ST-SC3511	ST-WRT15	-	-		
	S20R		11	●	●	20	>25	200	13	ST-SC3511	ST-WRT15	-	-		
	S25S		11	●	●	25	>32	250	17	ST-SC3511	ST-WRT15	-	-		
	S32T		11	●	●	32	>40	300	22	ST-SC3514	ST-WRT15	ST-SHDC11	ST-SC5011		
	S40T		11	●	●	40	>50	350	27	ST-SC3514	ST-WRT15	ST-SHDC11	ST-SC5011		

TURNING

GROOVING

THREADING

MILLING

DRILLING

ENDMILLS

DRILLS

SPARE PARTS

INDEX

carbide ▶ 30

PCBN ▶ 81

diamond ▶ 101

터닝

그라운드

나사

임핀

인서트 볼 드릴

엔드밀

슬리드 드릴

부품

색인표

^SSDXC

POSITIVE 7(인서트 여유각 7도) with Hole (스크류온 타입)

DC □□

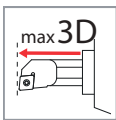
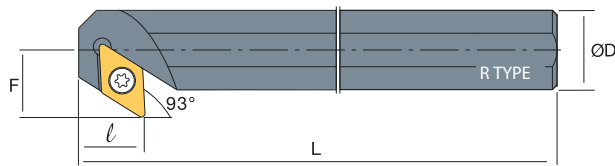
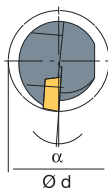

DC	DESCRIPTION 형번			STOCK 재고		DIMENSIONS 치수				ST-SC0257	ST-WRT08	-	-			
				R	L	ØD	Ød	L	F							
DC 0702	S12K	SDXCR/L	07	●	●	12	>17	125	09							
DC 11T3	S16P	SDXCR/L	11	●	●	16	>21	170	11							
	S20R		11	●	●	20	>25	200	13							
	S25S		11	●	●	25	>32	250	17							
	S32T		11	●	●	32	>40	300	22			ST-SHDC11	ST-SC5011			
	S40T		11	●	●	40	>50	350	27			ST-SHDC11	ST-SC5011			

적용인서트 ▶ 30

PCBN ▶ 81

다이아몬드 ▶ 101

TURNING 터닝

CSDQC

POSITIVE 7(인서트 여유각 7도)
with Hole (스크류온 타입)

DC □ □

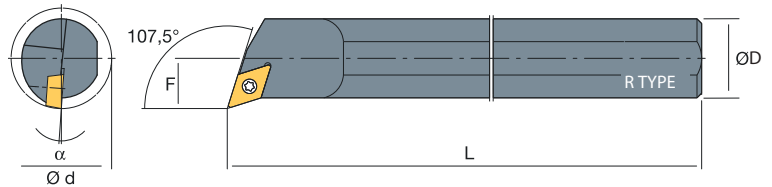
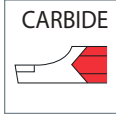
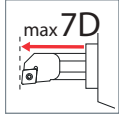

DC	DESCRIPTION 형번		STOCK 재고		DIMENSIONS 치수				←		←			
	R	L	ØD	Ød	L	F								
DC 0702	C10N	SDQCR/L	07	● ●	10	>14	160	09	ST-SC02555	ST-WRT08	-	-		
	C12Q		07	● ●	12	>18	180	11	ST-SC02555	ST-WRT08	-	-		
DC 11T3	C16X	SDQCR/L	11	● ●	16	>20	220	15	ST-SC3508	ST-WRT15	-	-		
	C20S		11	● ●	20	>25	250	19	ST-SC3508	ST-WRT15	-	-		
	C25T		11	● ●	25	>32	300	24	ST-SC3508	ST-WRT15	-	-		

carbide ▶ 30

PCBN ▶ 81

diamond ▶ 101



터닝

그라운드

나사

임핀

인테서블 드릴

엔드밀

슬리드 드릴

부품

색인표

CDJN

CLAMP ON
(클램프 온 타입)

DN □□

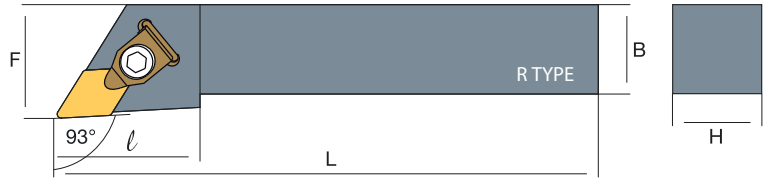

DN	DESCRIPTION 형번			STOCK 재고		DIMENSIONS 치수									
				R	L	H	B	L	F						
DN N1507	CDJNR/L	2525	M15	●	●	25	25	150	32	ST-SHDN15	ST-SC0410	ST-CS001	ST-SPR01	ST-SC630	ST-WR0030
		3232	P15	●	●	32	32	170	40	ST-SHDN15	ST-SC0410	ST-CS001	ST-SPR01	ST-SC630	ST-WR0030

PDJN

LEVER LOCK (레버락 타입)

DN □□

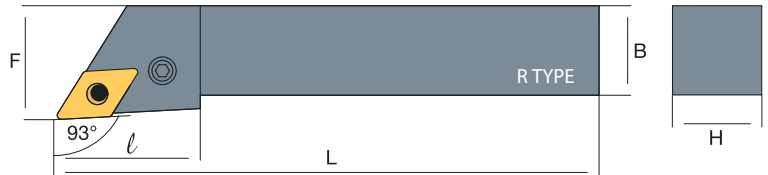

DN	DESCRIPTION 형번			STOCK 재고		DIMENSIONS 치수								
				R	L	H	B	L	F					
DN 1506	PDJNR/L	2020	K15	●	●	20	20	125	25	ST-SHDN15	ST-SPR001	ST-LV001	ST-SC820	ST-WR0030
		2525	M15	●	●	25	25	150	32	ST-SHDN15	ST-SPR001	ST-LV001	ST-SC820	ST-WR0030
		3232	P15	●	●	32	32	170	40	ST-SHDN15	ST-SPR001	ST-LV001	ST-SC820	ST-WR0030
		4040	S15	●	●	40	40	250	50	ST-SHDN15	ST-SPR001	ST-LV001	ST-SC820	ST-WR0030

적용인서트

33

PCBN

82

다이아몬드

102

PDNNN

LEVER LOCK (레버락 타입) **DN** □□

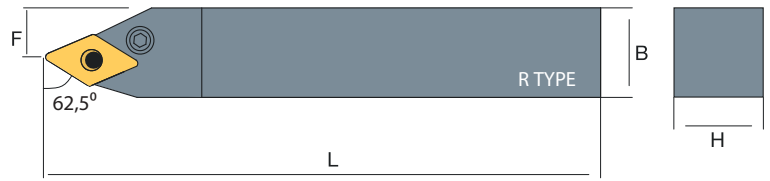

DN	DESCRIPTION 형번			STOCK 재고	DIMENSIONS 치수								
	PDNNN	형번	재고		H	B	L	F					
DN 1506	PDNNN	2020	K15	●	20	20	125	25	ST-SHDN15	ST-SPR001	ST-LV001	ST-SC820	ST-WR0030
		2525	M15	●	25	25	150	32	ST-SHDN15	ST-SPR001	ST-LV001	ST-SC820	ST-WR0030
		3232	P15	●	32	32	170	40	ST-SHDN15	ST-SPR001	ST-LV001	ST-SC820	ST-WR0030
		4040	S15	●	40	40	250	50	ST-SHDN15	ST-SPR001	ST-LV001	ST-SC820	ST-WR0030

TDHN

DOUBLE CLAMP (더블클램프 타입) **DN** □□

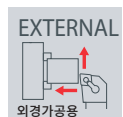
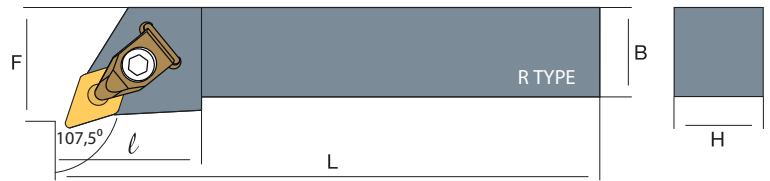
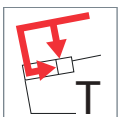

DN	DESCRIPTION 형번			STOCK 재고		DIMENSIONS 치수									
	TDHNR/L	형번	재고	R	L	H	B	L	F						
DN 1504	TDHNR/L	2525	M1504	●	●	25	25	150	32	ST-SHDN15	ST-SC0410	ST-CS001	ST-SPR04	ST-SC630	ST-WR0030
		3232	P1504	●	●	32	32	170	40	ST-SHDN15	ST-SC0410	ST-CS001	ST-SPR04	ST-SC630	ST-WR0030
DN 1506	TDHNR/L	2020	K15	●	●	20	20	125	25	ST-SHDN15	ST-SC0410	ST-CS001	ST-SPR04	ST-SC630	ST-WR0030
		2525	M15	●	●	25	25	150	32	ST-SHDN15	ST-SC0410	ST-CS001	ST-SPR04	ST-SC630	ST-WR0030
		3232	P15	●	●	32	32	170	40	ST-SHDN15	ST-SC0410	ST-CS001	ST-SPR04	ST-SC630	ST-WR0030

carbide

33

PCBN

82

diamond

102

터닝

그라운드

나사

임핀

인테서블 드릴

엔드밀

솔리드 드릴

부품

색인표

TDJN

DOUBLE CLAMP
(더블클램프 타입)

DN □□

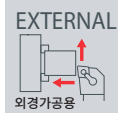
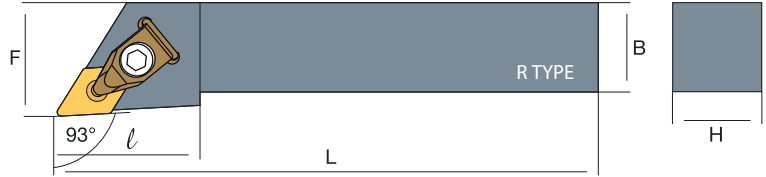
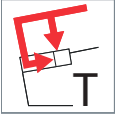

DN	DESCRIPTION 형번			STOCK 재고		DIMENSIONS 치수									
				R	L	H	B	L	F						
DN 1104	TDJNR/L	1616	H11	●	●	16	16	100	20	ST-SHDN11	ST-SC0410	ST-CS001	ST-SPR04	ST-SC523	ST-WR0030
		2020	K11	●	●	20	20	125	25	ST-SHDN11	ST-SC0410	ST-CS001	ST-SPR04	ST-SC523	ST-WR0030
		2525	M11	●	●	25	25	150	32	ST-SHDN11	ST-SC0410	ST-CS001	ST-SPR04	ST-SC523	ST-WR0030
DN 1504	TDJNR/L	2020	K1504	●	●	20	20	125	25	ST-SHDN15	ST-SC0410	ST-CS002	ST-SPR04	ST-SC630	ST-WR0030
		2525	M1504	●	●	25	25	150	32	ST-SHDN15	ST-SC0410	ST-CS002	ST-SPR04	ST-SC630	ST-WR0030
		3232	P1504	●	●	32	32	170	40	ST-SHDN15	ST-SC0410	ST-CS002	ST-SPR04	ST-SC630	ST-WR0030
DN 1506	TDJNR/L	2020	K15	●	●	20	20	125	25	ST-SHDN15	ST-SC0410	ST-CS002	ST-SPR04	ST-SC630	ST-WR0030
		2525	M15	●	●	25	25	150	32	ST-SHDN15	ST-SC0410	ST-CS002	ST-SPR04	ST-SC630	ST-WR0030
		3232	P15	●	●	32	32	170	40	ST-SHDN15	ST-SC0410	ST-CS002	ST-SPR04	ST-SC630	ST-WR0030
		4040	S15	●	●	40	40	250	50	ST-SHDN15	ST-SC0410	ST-CS002	ST-SPR04	ST-SC630	ST-WR0030

적용인서트

33

PCBN

82

다이아몬드

102

TDNNN

DOUBLE CLAMP
 (더블클램프 타입)

DN



CN	TDNNN	DESCRIPTION 형번			STOCK 재고	DIMENSIONS 치수								
		1616	H11	●		H	B	L	F	ST-SHDN	ST-SC	ST-CS	ST-SPR	ST-SC
DN 1104		1616	H11	●	16	16	100	20	ST-SHDN11	ST-SC0410	ST-CS001	ST-SPR04	ST-SC523	ST-WR0030
		2020	K11	●	20	20	125	25	ST-SHDN11	ST-SC0410	ST-CS001	ST-SPR04	ST-SC523	ST-WR0030
		2525	M11	●	25	25	150	32	ST-SHDN11	ST-SC0410	ST-CS001	ST-SPR04	ST-SC523	ST-WR0030
DN 1504		2020	K1504	●	20	20	125	25	ST-SHDN15	ST-SC0410	ST-CS002	ST-SPR04	ST-SC630	ST-WR0030
		2525	M1504	●	25	25	150	32	ST-SHDN15	ST-SC0410	ST-CS002	ST-SPR04	ST-SC630	ST-WR0030
		3232	P1504	●	32	32	170	40	ST-SHDN15	ST-SC0410	ST-CS002	ST-SPR04	ST-SC630	ST-WR0030
DN 1506		2020	K15	●	20	20	125	25	ST-SHDN15	ST-SC0410	ST-CS002	ST-SPR04	ST-SC630	ST-WR0030
		2525	M15	●	25	25	150	32	ST-SHDN15	ST-SC0410	ST-CS002	ST-SPR04	ST-SC630	ST-WR0030
		3232	P15	●	32	32	170	40	ST-SHDN15	ST-SC0410	ST-CS002	ST-SPR04	ST-SC630	ST-WR0030
		4040	S15	●	40	40	250	50	ST-SHDN15	ST-SC0410	ST-CS002	ST-SPR04	ST-SC630	ST-WR0030

- TURNING
- GROOVING
- THREADING
- MILLING
- DRILLING
- ENDMILLS
- DRILLS
- SPARE PARTS
- INDEX

carbide 33

PCBN 82

diamond 102



터닝

그라운드

나사

임핀

인테서블 드릴

엔드밀

슬리드 드릴

부품

색인표

^SPDQN

LEVER LOCK (레버락 타입) DN □□

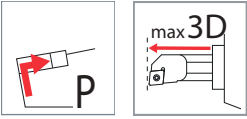
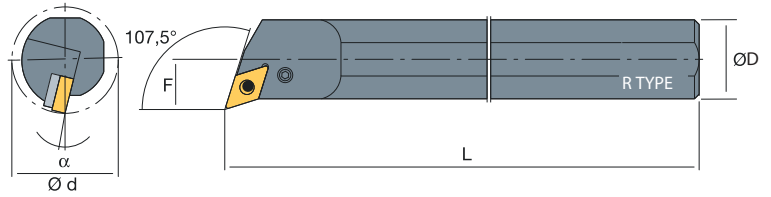

DN	DESCRIPTION 형번		STOCK 재고	DIMENSIONS 치수				ST-SHDN15	ST-SPR001	ST-LV001	ST-SC820	ST-WR0030	
				R	L	ØD	Ød						L
DN 1506	S25S	PDQNR/L	15	●	●	25	40	250	17				
	S32T		15	●	●	32	40	300	22				
	S40U		15	●	●	40	50	350	27				
	S50V		15	●	●	50	63	400	35				

^SPDUN

LEVER LOCK (레버락 타입) DN □□

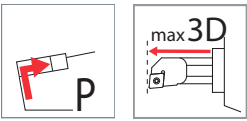
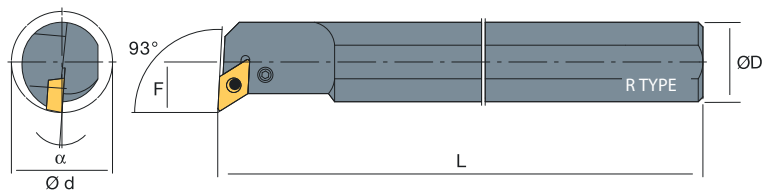

DN	DESCRIPTION 형번		STOCK 재고	DIMENSIONS 치수				ST-SHDN15	ST-SPR001	ST-LV001	ST-SC820	ST-WR0030
				R	L	ØD	Ød					
DN 1506	S32T	PDUNR/L	15	●	●	32	40	300	22			
	S40U		15	●	●	40	50	350	27			
	S50V		15	●	●	50	63	400	35			

적용인서트 ▶ 33

PCBN ▶ 82

다이아몬드 ▶ 102

STDQN

DOUBLE CLAMP
(더블클램프 타입)

DN □□

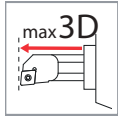
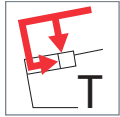
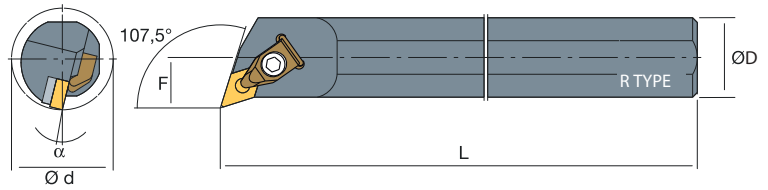

DN	DESCRIPTION 형번		STOCK 재고		DIMENSIONS 치수									
			R	L	ØD	Ød	L	F						
DN 1104	S25S	TDQNR/L	11	● ●	25	32	250	17	ST-SHDN11	ST-SC0410	ST-CS002	ST-SPR04	ST-SC523	ST-WR0030
	S32T		11	● ●	32	40	300	22	ST-SHDN11	ST-SC0410	ST-CS002	ST-SPR04	ST-SC523	ST-WR0030
DN 1506	S25S	TDQNR/L	15	● ●	25	32	250	17	ST-SHDN15	ST-SC0410	ST-CS001	ST-SPR04	ST-SC630	ST-WR0030
	S32T		15	● ●	32	40	300	22	ST-SHDN15	ST-SC0410	ST-CS001	ST-SPR04	ST-SC630	ST-WR0030
	S40U		15	● ●	40	50	350	27	ST-SHDN15	ST-SC0410	ST-CS001	ST-SPR04	ST-SC630	ST-WR0030
	S50V		15	● ●	50	63	400	35	ST-SHDN15	ST-SC0410	ST-CS001	ST-SPR04	ST-SC630	ST-WR0030

STDUN

DOUBLE CLAMP
(더블클램프 타입)

DN □□

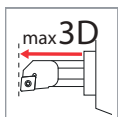
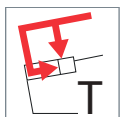
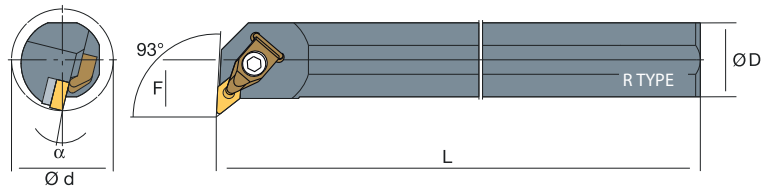

DN	DESCRIPTION 형번		STOCK 재고		DIMENSIONS 치수									
			R	L	ØD	Ød	L	F						
DN 1104	S25S	TDUNR/L	11	● ●	25	32	250	17	ST-SHDN11	ST-SC0410	ST-CS002	ST-SPR04	ST-SC523	ST-WR0030
	S32T		11	● ●	32	40	300	22	ST-SHDN11	ST-SC0410	ST-CS002	ST-SPR04	ST-SC523	ST-WR0030
DN 1506	S25S	TDUNR/L	15	● ●	25	32	250	17	ST-SHDN15	ST-SC0410	ST-CS001	ST-SPR04	ST-SC630	ST-WR0030
	S32T		15	● ●	32	40	300	22	ST-SHDN15	ST-SC0410	ST-CS001	ST-SPR04	ST-SC630	ST-WR0030
	S40U		15	● ●	40	50	350	27	ST-SHDN15	ST-SC0410	ST-CS001	ST-SPR04	ST-SC630	ST-WR0030
	S50V		15	● ●	50	63	400	35	ST-SHDN15	ST-SC0410	ST-CS001	ST-SPR04	ST-SC630	ST-WR0030

carbide

33

PCBN

82

diamond

102

터닝

그루브

나사

임핀

인테셔널 드릴

엔드밀

솔리드 드릴

부품

색인표

STD-N

DOUBLE CLAMP
(더블클램프 타입)

DN □□

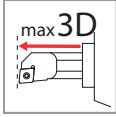
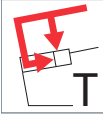
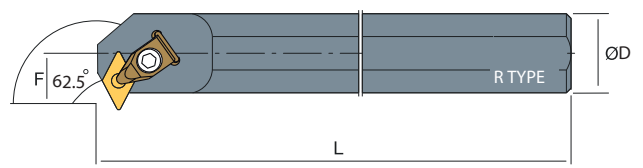
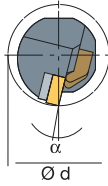

DN	DESCRIPTION 형번			STOCK 재고		DIMENSIONS 치수									
				R	L	ØD	Ød	L	F						
DN 1104	S25S	TD-NR/L	11	●	●	25	32	250	17	ST-SHDN11	ST-SC0410	ST-CS002	ST-SPR04	ST-SC523	ST-WR0030
DN 1506	S32T	TD-NR/L	15	●	●	32	44	300	26	ST-SHDN15	ST-SC0410	ST-CS001	ST-SPR04	ST-SC630	ST-WR0030
	S40U		15	●	●	40	52	350	29	ST-SHDN15	ST-SC0410	ST-CS001	ST-SPR04	ST-SC630	ST-WR0030
	S50V		15	●	●	50	67	400	35	ST-SHDN15	ST-SC0410	ST-CS001	ST-SPR04	ST-SC630	ST-WR0030

적용인서트

33

PCBN

82

다이아몬드

102

CKJN

CLAMP ON (클램프 온 타입)

KN □□

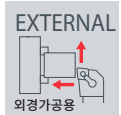
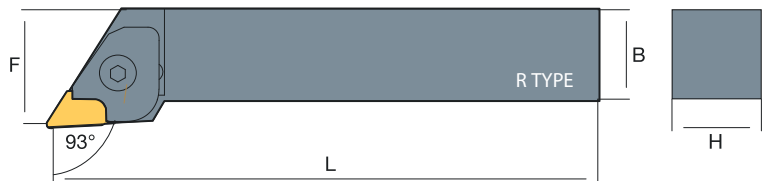

KN	DESCRIPTION 형번			STOCK 재고		DIMENSIONS 치수									
				R	L	H	B	L	F						
KN N1604	CKJNR/L	2020	K16	●	●	25	25	125		ST-SHKN16	ST-SC0310	ST-CS011	-	ST-SC630	ST-WR0050
		2525	M16	●	●	25	25	150		ST-SHKN16	ST-SC0310	ST-CS011	-	ST-SC630	ST-WR0050
		3232	P16	●	●	32	32	170		ST-SHKN16	ST-SC0310	ST-CS011	-	ST-SC630	ST-WR0050
		4040	S16	●	●	40	40	250		ST-SHKN16	ST-SC0310	ST-CS011	-	ST-SC630	ST-WR0050

S^{CKUN}

CLAMP ON (클램프 온 타입)

KN □□

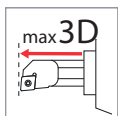
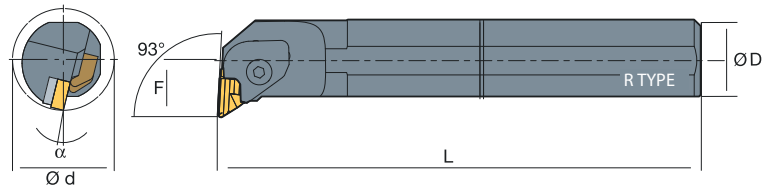

KN	DESCRIPTION 형번			STOCK 재고		DIMENSIONS 치수									
				R	L	ØD	Ød	L	F						
KN 1604	S25S	CKUNR/L	16	●	●	25	34	250	17	ST-SHKN16	ST-SC0310	ST-CS011	-	ST-SC630	ST-WR0050
	S28S		16	●	●	28	38	250	17	ST-SHKN16	ST-SC0310	ST-CS011	-	ST-SC630	ST-WR0050
	S32T		16	●	●	32	40	300	22	ST-SHKN16	ST-SC0310	ST-CS011	-	ST-SC630	ST-WR0050
	S40U		16	●	●	40	50	350	27	ST-SHKN16	ST-SC0310	ST-CS011	-	ST-SC630	ST-WR0050
	S50V		16	●	●	50	63	400	35	ST-SHKN16	ST-SC0310	ST-CS001	ST-SPR04	ST-SC630	ST-WR0030

carbide

37

터너

그라운드

나사

미립

인테그럴 드릴

엔드밀

슬리드 드릴

부품

색인표

CRDCN

CLAMP ON (클램프 온 타입)

RC □□

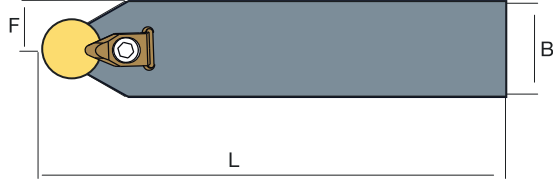

RC	DESCRIPTION 형번			STOCK 재고		DIMENSIONS 치수									
				R	L	H	B	L	F						
RCGX0606	CRDCN	2020	K06	●	●	20	20	125	10	ST-SHRC06	ST-SCRC6	ST-CSRC6	-	ST-SCRC6	ST-WR0040
		2525	M06	●	●	25	25	150	12.5	ST-SHRC06	ST-SCRC6	ST-CSRC6	-	ST-SCRC6	ST-WR0040
		3232	P06	●	●	32	32	170	16	ST-SHRC06	ST-SCRC6	ST-CSRC6	-	ST-SCRC6	ST-WR0040
		4040	S06	●	●	40	40	250	20	ST-SHRC06	ST-SCRC6	ST-CSRC6	-	ST-SCRC6	ST-WR0040
RCGX0907	CRDCN	2020	K09	●	●	20	20	125	10	ST-SHRC06	ST-SCRC9	ST-CSRC9	-	ST-SCRC9	ST-WR0040
		2525	M09	●	●	25	25	150	12.5	ST-SHRC06	ST-SCRC9	ST-CSRC9	-	ST-SCRC9	ST-WR0040
		3232	P09	●	●	32	32	170	16	ST-SHRC06	ST-SCRC9	ST-CSRC9	-	ST-SCRC9	ST-WR0040
		4040	S09	●	●	40	40	250	20	ST-SHRC06	ST-SCRC9	ST-CSRC9	-	ST-SCRC9	ST-WR0040
RCGX1207	CRDCN	2020	K12	●	●	20	20	125	10	ST-SHRC06	ST-SCR12	ST-CSR12	-	ST-SCR12	ST-WR0040
		2525	M12	●	●	25	25	150	12.5	ST-SHRC06	ST-SCR12	ST-CSR12	-	ST-SCR12	ST-WR0040
		3232	P12	●	●	32	32	170	16	ST-SHRC06	ST-SCR12	ST-CSR12	-	ST-SCR12	ST-WR0040
		4040	S12	●	●	40	40	250	20	ST-SHRC06	ST-SCR12	ST-CSR12	-	ST-SCR12	ST-WR0040
RCGX1510	CRDCN	2020	K15	●	●	20	20	125	10	ST-SHRC06	ST-SCR15	ST-CSR15	-	ST-SCR15	ST-WR0040
		2525	M15	●	●	25	25	150	12.5	ST-SHRC06	ST-SCR15	ST-CSR15	-	ST-SCR15	ST-WR0040
		3232	P15	●	●	32	32	170	16	ST-SHRC06	ST-SCR15	ST-CSR15	-	ST-SCR15	ST-WR0040
		4040	S15	●	●	40	40	250	20	ST-SHRC06	ST-SCR15	ST-CSR15	-	ST-SCR15	ST-WR0040
RCGX1910	CRDCN	2020	K19	●	●	20	20	125	10	ST-SHRC06	ST-SCR19	ST-CSR19	-	ST-SCR19	ST-WR0040
		2525	M19	●	●	25	25	150	12.5	ST-SHRC06	ST-SCR19	ST-CSR19	-	ST-SCR19	ST-WR0040
		3232	P19	●	●	32	32	170	16	ST-SHRC06	ST-SCR19	ST-CSR19	-	ST-SCR19	ST-WR0040
		4040	S19	●	●	40	40	250	20	ST-SHRC06	ST-SCR19	ST-CSR19	-	ST-SCR19	ST-WR0040
RCGX2512	CRDCN	2020	K25	●	●	20	20	125	10	ST-SHRC06	ST-SCR25	ST-CSR25	-	ST-SCR25	ST-WR0040
		2525	M25	●	●	25	25	150	12.5	ST-SHRC06	ST-SCR25	ST-CSR25	-	ST-SCR25	ST-WR0040
		3232	P25	●	●	32	32	170	16	ST-SHRC06	ST-SCR25	ST-CSR25	-	ST-SCR25	ST-WR0040
		4040	S25	●	●	40	40	250	20	ST-SHRC06	ST-SCR25	ST-CSR25	-	ST-SCR25	ST-WR0040

적용인서트

38

PCBN

83

SRDCN

POSITIVE 7(인서트 여유각 7도)
with Hole (스크류온 타입)

RC□□

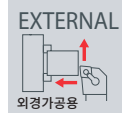
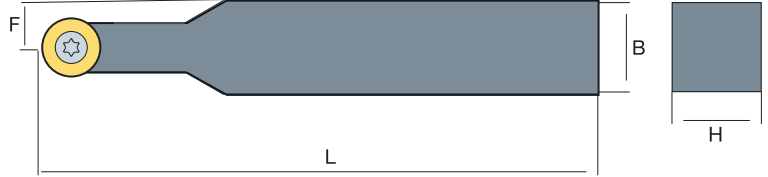

RC	DESCRIPTION			STOCK 재고	DIMENSIONS 치수										
	형번				H	B	L	F							
RC 0602	SRDCN	1616	H06	●	16	16	100	8	ST-SC2507	ST-WRT08	-	-			
		2020	K06	●	20	20	125	10	ST-SC2507	ST-WRT08	-	-			
		2525	M06	●	25	25	150	12.5	ST-SC2507	ST-WRT08	-	-			
RC 0803	SRDCN	1616	H08	●	16	16	100	8	ST-SC3009	ST-WRT08	-	-			
		2020	K08	●	20	20	125	10	ST-SC3009	ST-WRT08	-	-			
		2525	M08	●	25	25	150	12.5	ST-SC3009	ST-WRT08	-	-			
		3232	P08	●	32	32	170	16	ST-SC3009	ST-WRT08	-	-			
RC 1003	SRDCN	1616	H10	●	16	16	100	8	ST-SC3511	ST-WRT15	-	-			
		2020	K10	●	20	20	125	10	ST-SC3511	ST-WRT15	-	-			
		2525	M10	●	25	25	150	12.5	ST-SC3511	ST-WRT15	-	-			
		3232	P10	●	32	32	170	16	ST-SC3511	ST-WRT15	-	-			
RC 1204	SRDCN	2020	K12	●	20	20	125	10	ST-SC3511	ST-WRT15	-	-			
		2525	M12	●	25	25	150	12.5	ST-SC3511	ST-WRT15	-	-			
		3232	P12	●	32	32	170	16	ST-SC3511	ST-WRT15	-	-			
RC 1605	SRDCN	2525	M16	●	25	25	150	12.5	ST-SC0512	ST-WRT20	-	-			
		3232	P16	●	32	32	170	16	ST-SC0512	ST-WRT20	-	-			
RC 2006	SRDCN	2525	M20	●	25	25	150	12.5	ST-SC0616	ST-WRT20	-	-			
		3232	P20	●	32	32	170	16	ST-SC0616	ST-WRT20	-	-			
		4040	S20	●	40	40	250	20	ST-SC3514	ST-WRT20	-	-			

- TURNING
- GROOVING
- THREADING
- MILLING
- DRILLING
- ENDMILLS
- DRILLS
- SPARE PARTS
- INDEX

carbide ▶ 38

PCBN ▶ 83

터닝

그라운드

나사

외경

인서트 볼 드릴

엔드밀

볼리드 드릴

부품

색인표

SRGC

POSITIVE 7(인서트 여유각 7도) with Hole (스크류온 타입) **RC□□**

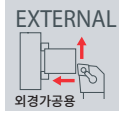
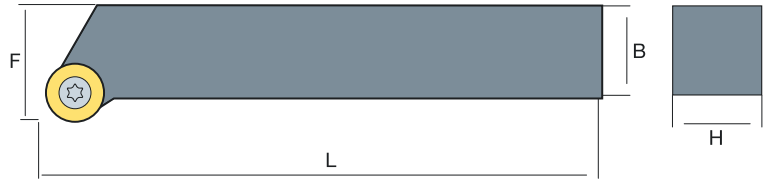

RC	DESCRIPTION 형번			STOCK 재고		DIMENSIONS 치수				←		←			
				R	L	H	B	L	F	←	←				
RC 0602	SRGCR/L	1616	H06	●	●	16	16	100	20	ST-SC2507	ST-WRT08	-	-		
		2020	K06	●	●	20	20	125	25	ST-SC2507	ST-WRT08	-	-		
		2525	M06	●	●	25	25	150	32	ST-SC2507	ST-WRT08	-	-		
RC 0803	SRGCR/L	1616	H08	●	●	16	16	100	20	ST-SC3009	ST-WRT08	-	-		
		2020	K08	●	●	20	20	125	25	ST-SC3009	ST-WRT08	-	-		
		2525	M08	●	●	25	25	150	32	ST-SC3009	ST-WRT08	-	-		
		3232	P08	●	●	32	32	170	40	ST-SC3009	ST-WRT08	-	-		
RC 1003	SRGCR/L	1616	H10	●	●	16	16	100	20	ST-SC3511	ST-WRT15	-	-		
		2020	K10	●	●	20	20	125	25	ST-SC3511	ST-WRT15	-	-		
		2525	M10	●	●	25	25	150	32	ST-SC3511	ST-WRT15	-	-		
		3232	P10	●	●	32	32	170	40	ST-SC3511	ST-WRT15	-	-		
RC 1204	SRGCR/L	2020	K12	●	●	20	20	125	25	ST-SC3511	ST-WRT15	-	-		
		2525	M12	●	●	25	25	150	32	ST-SC3511	ST-WRT15	-	-		
		3232	P12	●	●	32	32	170	40	ST-SC3511	ST-WRT15	-	-		
RC 1605	SRGCR/L	2525	M16	●	●	25	25	150	32	ST-SC0512	ST-WRT20	-	-		
		3232	P16	●	●	32	32	170	40	ST-SC0512	ST-WRT20	-	-		
RC 2006	SRGCR/L	2525	M20	●	●	25	25	150	32	ST-SC0616	ST-WRT20	-	-		
		3232	P20	●	●	32	32	170	40	ST-SC0616	ST-WRT20	-	-		

적용인서트 ▶ 38



PCBN ▶ 83

SRHC

POSITIVE 7(인서트 여유각 7도)
 with Hole (스크류온 타입)

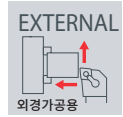
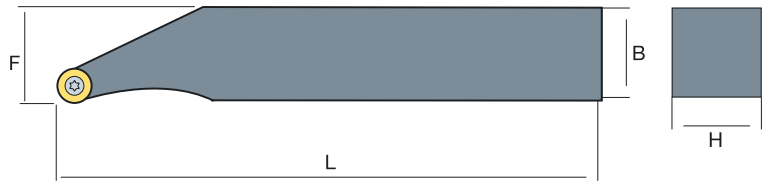
RC□□



RC	DESCRIPTION 형번				STOCK 재고	DIMENSIONS 치수									
						H	B	L	F						
RC 10T3	SRHCR/L	2020	K10	●	20	20	120	20	ST-SC3511	ST-WRT15	-	-			
		2525	K10	●	25	25	125	25	ST-SC3511	ST-WRT15	-	-			
RC 1204	SRHCR/L	2020	K12	●	20	20	120	20	ST-SC3514	ST-WRT15	-	-			
		2525	K12	●	25	25	125	25	ST-SC3514	ST-WRT15	-	-			
RC 1606	SRHCR/L	2020	K16	●	20	20	120	20	ST-SC0512	ST-WRT20	-	-			
		2525	K16	●	25	25	125	25	ST-SC0512	ST-WRT20	-	-			

TURNING

GROOVING

THREADING

MILLING

DRILLING

ENDMILLS

DRILLS

SPARE PARTS

INDEX

carbide

38

PCBN

83

터닝

그루브

나사

밀링

인테셔널 드릴

엔드밀

솔리드 드릴

부품

색인표

SSDCN

POSITIVE 7(인서트 여유각 7도)
with Hole (스크류온 타입)

SC□□

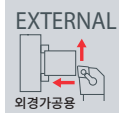
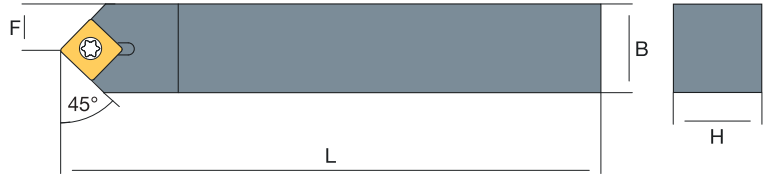

SC	DESCRIPTION 형번				STOCK 재고	DIMENSIONS 치수				←	←			
	H	B	L	F										
SC 09T3	SSDCN	1212	F09	●	12	12	80	6	ST-SC3511	ST-WRT15	-	-		
		1616	H09	●	16	16	100	8	ST-SC3514	ST-WRT15	ST-SHSC09	ST-SC5011		
		2020	K09	●	20	20	125	10	ST-SC3514	ST-WRT15	ST-SHSC09	ST-SC5011		
		2525	M09	●	25	25	150	12.5	ST-SC3514	ST-WRT15	ST-SHSC09	ST-SC5011		
SC 1204	SSDCN	1616	H12	●	16	16	100	8	ST-SC4016	ST-WRT15	ST-SHSC12	ST-SC6011		
		2020	K12	●	20	20	125	10	ST-SC4016	ST-WRT15	ST-SHSC12	ST-SC6011		
		2525	M12	●	25	25	150	12.5	ST-SC4016	ST-WRT15	ST-SHSC12	ST-SC6011		

적용인서트





39

SSSC

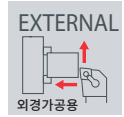
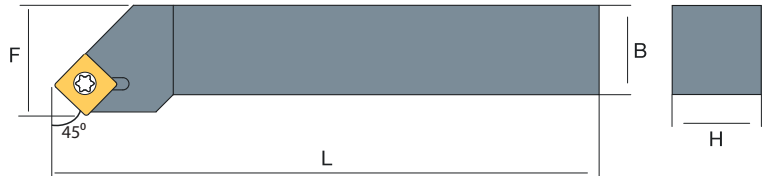
POSITIVE 7(인서트 여유각 7도)
 with Hole (스크류온 타입)

SC



SC	DESCRIPTION 형번			STOCK 재고		DIMENSIONS 치수				 ← 		 ← 			
				R	L	H	B	L	F						
SC 09T3	SSSCR/L 1212	F09	● ●	12	12	80	16	ST-SC3511	ST-WRT15	-	-				
	1616	H09	● ●	16	16	100	20	ST-SC3511	ST-WRT15	ST-SHSC09	ST-SC5011				
	2020	K09	● ●	20	20	125	25	ST-SC3511	ST-WRT15	ST-SHSC09	ST-SC5011				
	2525	M09	● ●	25	25	150	32	ST-SC3511	ST-WRT15	ST-SHSC09	ST-SC5011				
SC 1204	SSSCR/L 1616	H12	● ●	16	16	100	20	ST-SC4016	ST-WRT15	ST-SHSC12	ST-SC6011				
	2020	K12	● ●	20	20	125	25	ST-SC4016	ST-WRT15	ST-SHSC12	ST-SC6011				
	2525	M12	● ●	25	25	150	32	ST-SC4016	ST-WRT15	ST-SHSC12	ST-SC6011				

TURNING

GROOVING

THREADING

MILLING

DRILLING

ENDMILLS

DRILLS

SPARE PARTS

INDEX

carbide

39

터닝

그라운드

나사

밀링

인테셔널 드릴

엔드밀

슬리드 드릴

부품

색인표

^sSSSC

POSITIVE 7(인서트 여유각 7도) with Hole (스크류온 타입) **SC** □□

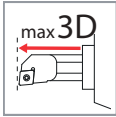
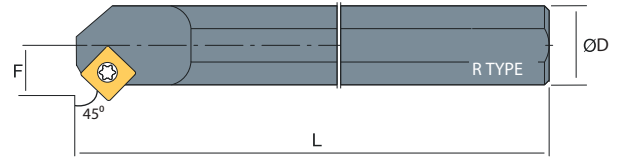

SC	DESCRIPTION 형번		STOCK 재고		DIMENSIONS 치수				←		←						
			R	L	ØD	Ød	L	F									
SC 09T3	S16P	SSSCR/L	09	●	●	16	>21	170	11	ST-SC3511	ST-WRT15	-	-				
	S20R		09	●	●	20	>25	200	13	ST-SC3511	ST-WRT15	-	-				
	S25S		09	●	●	25	>32	250	17	ST-SC3514	ST-WRT15	ST-SHSC09	ST-SC5011				
SC 1204	S32T	SSSCR/L	12	●	●	32	>40	300	22	ST-SC4016	ST-WRT20	ST-SHSC12	ST-SC6011				
	S40T		12	●	●	40	>50	350	27	ST-SC4016	ST-WRT20	ST-SHSC12	ST-SC6011				

CSDNN

CLAMP ON (클램프 온 타입) **SN** □□



SN	DESCRIPTION 형번		STOCK 재고		DIMENSIONS 치수				←		← ← ←			
					H	B	L	F						
SN N1207	CSDNN	2525	M12	●	25	25	150	32	ST-SHSN12	ST-SC0410	ST-CS010	ST-SR001	ST-SC630	ST-WR0030
		3232	P12	●	32	32	170	40	ST-SHSN12	ST-SC0410	ST-CS010	ST-SR001	ST-SC630	ST-WR0030

적용인서트 40

PCBN 86

CSSN

CLAMP ON (클램프 온 타입) **SN** □□

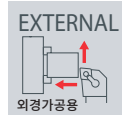
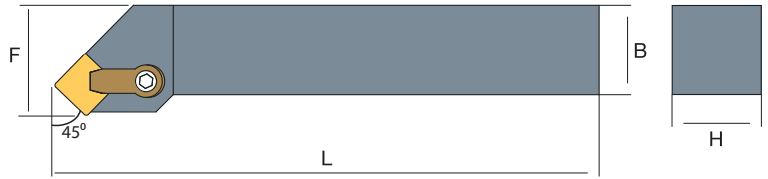

SN	DESCRIPTION 형번			STOCK 재고		DIMENSIONS 치수									
				R	L	H	B	L	F						
SN N1207	CSSNN	2525	M12	●	●	25	25	150	32	ST-SHSN12	ST-SC0410	ST-CS010	ST-SR001	ST-SC630	ST-WR0030
		3232	P12	●	●	32	32	170	40	ST-SHSN12	ST-SC0410	ST-CS010	ST-SR001	ST-SC630	ST-WR0030

PSBN

LEVER LOCK (레버락 타입) **SN** □□

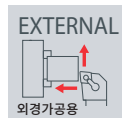

SN	DESCRIPTION 형번			STOCK 재고		DIMENSIONS 치수									
				R	L	H	B	L	F						
SN 1204	PSBNR/L	2020	K12	●	●	20	20	125	17	ST-SHSN12	ST-SPR001	ST-LV001	ST-SC820	ST-WR0030	
		2525	M12	●	●	25	25	150	22	ST-SHSN12	ST-SPR001	ST-LV001	ST-SC820	ST-WR0030	
		3232	P12	●	●	32	32	170	27	ST-SHSN12	ST-SPR001	ST-LV001	ST-SC820	ST-WR0030	
SN 1504	PSBNR/L	2525	M15	●	●	25	25	150	22	ST-SHSN15	ST-SPR002	ST-LV002	ST-SC822	ST-WR0050	
		3232	P15	●	●	32	32	170	27	ST-SHSN15	ST-SPR002	ST-LV002	ST-SC822	ST-WR0050	
SN 1906	PSBNR/L	3232	P19	●	●	32	32	170	27	ST-SHSN19	ST-SPR003	ST-LV003	ST-SC1025	ST-WR0060	
		4040	S19	●	●	40	40	250	35	ST-SHSN19	ST-SPR003	ST-LV003	ST-SC1025	ST-WR0060	

carbide

40

PCBN

86

터닝

그라운드

나사

임베디드

인테그럴 드릴

엔드밀

슬리드 드릴

부품

색인표

PSDNN

LEVER LOCK (레버락 타입)

SN □□

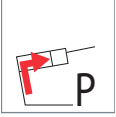



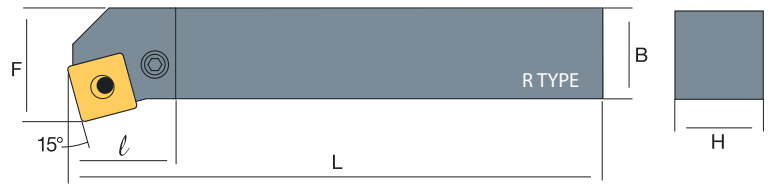

SN	DESCRIPTION 형번			STOCK 재고	DIMENSIONS 치수								
					H	B	L	F					
SN 1204	PSDNN	2020	K12	●	20	20	125	10	ST-SHSN12	ST-SPR001	ST-LV001	ST-SC820	ST-WR0030
		2525	M12	●	25	25	150	12.5	ST-SHSN12	ST-SPR001	ST-LV001	ST-SC820	ST-WR0030
		3232	P12	●	32	32	170	16	ST-SHSN12	ST-SPR001	ST-LV001	ST-SC820	ST-WR0030
SN 1504	PSDNN	2525	M15	●	25	25	150	12.5	ST-SHSN15	ST-SPR002	ST-LV002	ST-SC822	ST-WR0050
		3232	P15	●	32	32	170	16	ST-SHSN15	ST-SPR002	ST-LV002	ST-SC822	ST-WR0050
SN 1906	PSDNN	3232	P19	●	32	32	170	16	ST-SHSN19	ST-SPR003	ST-LV003	ST-SC1025	ST-WR0060
		4040	S19	●	40	40	250	20	ST-SHSN19	ST-SPR003	ST-LV003	ST-SC1025	ST-WR0060

PSKN

LEVER LOCK (레버락 타입) **SN** □ □



SN	DESCRIPTION 형번			STOCK 재고		DIMENSIONS 치수								
				R	L	H	B	L	F					
SN 1204	PSKNR/L	2020	K12	●	●	20	20	125	25	ST-SHSN12	ST-SPR001	ST-LV001	ST-SC820	ST-WR0030
		2525	M12	●	●	25	25	150	32	ST-SHSN12	ST-SPR001	ST-LV001	ST-SC820	ST-WR0030
		3232	P12	●	●	32	32	170	40	ST-SHSN12	ST-SPR001	ST-LV001	ST-SC820	ST-WR0030
SN 1504	PSKNR/L	2525	M15	●	●	25	25	150	32	ST-SHSN15	ST-SPR002	ST-LV002	ST-SC822	ST-WR0050
		3232	P15	●	●	32	32	170	40	ST-SHSN15	ST-SPR002	ST-LV002	ST-SC822	ST-WR0050
SN 1906	PSKNR/L	3232	P19	●	●	32	32	170	40	ST-SHSN19	ST-SPR003	ST-LV003	ST-SC1025	ST-WR0060
		4040	S19	●	●	40	40	250	50	ST-SHSN19	ST-SPR003	ST-LV003	ST-SC1025	ST-WR0060

carbide  40

PCBN  86



- TURNING
- GROOVING
- THREADING
- MILLING
- DRILLING
- ENDMILLS
- DRILLS
- SPARE PARTS
- INDEX

터닝

그라운드

나사

임핀

인테셔널 드릴

엔드밀

슬리드 드릴

부품

색인표

PSSN

LEVER LOCK (레버락 타입)

SN □□

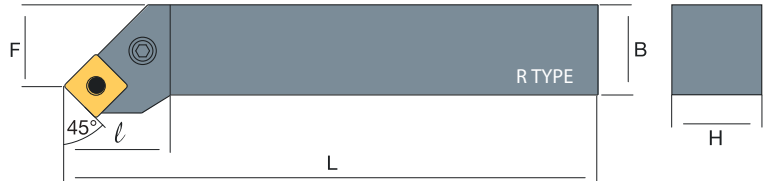

SN	DESCRIPTION 형번			STOCK 재고		DIMENSIONS 치수								
				R	L	H	B	L	F					
SN 1204	PSSNR/L	2020	K12	●	●	20	20	125	25	ST-SHSN12	ST-SPR001	ST-LV001	ST-SC820	ST-WR0030
		2525	M12	●	●	25	25	150	32	ST-SHSN12	ST-SPR001	ST-LV001	ST-SC820	ST-WR0030
		3232	P12	●	●	32	32	170	40	ST-SHSN12	ST-SPR001	ST-LV001	ST-SC820	ST-WR0030
SN 1504	PSSNR/L	3232	P15	●	●	32	32	170	40	ST-SHSN15	ST-SPR002	ST-LV002	ST-SC822	ST-WR0050
SN 1906	PSSNR/L	3232	P19	●	●	32	32	170	40	ST-SHSN19	ST-SPR003	ST-LV003	ST-SC1025	ST-WR0060
		4040	S19	●	●	40	40	250	50	ST-SHSN19	ST-SPR003	ST-LV003	ST-SC1025	ST-WR0060

TSDNN

DOUBLE CLAMP
(더블클램프 타입)

SN □□

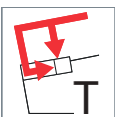

SN	DESCRIPTION 형번			STOCK 재고	DIMENSIONS 치수									
					H	B	L	F						
SN 1204	TSDNN	2020	K12	●	20	20	125	10	ST-SHSN12	ST-SC0410	ST-CS001	ST-SPR04	ST-SC630	ST-WR0030
		2525	M12	●	25	25	150	12.5	ST-SHSN12	ST-SC0410	ST-CS001	ST-SPR04	ST-SC630	ST-WR0030
		3232	P12	●	32	32	170	16	ST-SHSN12	ST-SC0410	ST-CS001	ST-SPR04	ST-SC630	ST-WR0030
SN 1504	TSDNN	2525	M15	●	25	25	150	12.5	ST-SHSN15	ST-SC6169	ST-CS003	-	ST-SC6307	ST-WR0040
		3232	P15	●	32	32	170	16	ST-SHSN15	ST-SC6169	ST-CS003	-	ST-SC6307	ST-WR0040
		4040	S15	●	40	40	250	20	ST-SHSN15	ST-SC6169	ST-CS003	-	ST-SC6307	ST-WR0040

적용인서트

40

PCBN

86

TSKN

DOUBLE CLAMP
 (더블클램프 타입)

SN □□

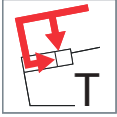

SN	DESCRIPTION 형번			STOCK 재고		DIMENSIONS 치수									
	R	L	H	B	L	F									
SN 1204	TSKNR/L	2020	K12	●	●	20	20	125	25	ST-SHSN12	ST-SC0410	ST-CS001	ST-SPR04	ST-SC630	ST-WR0030
		2525	M12	●	●	25	25	150	32	ST-SHSN12	ST-SC0410	ST-CS001	ST-SPR04	ST-SC630	ST-WR0030
		3232	P12	●	●	32	32	170	40	ST-SHSN12	ST-SC0410	ST-CS001	ST-SPR04	ST-SC630	ST-WR0030
SN 1504	TSKNR/L	2525	M15	●	●	25	25	150	32	ST-SHSN15	ST-SC0616	ST-CS003	-	ST-SC6307	ST-WR0040
		3232	P15	●	●	32	32	170	40	ST-SHSN15	ST-SC0616	ST-CS003	-	ST-SC6307	ST-WR0040

TSSN

DOUBLE CLAMP
 (더블클램프 타입)

SN □□

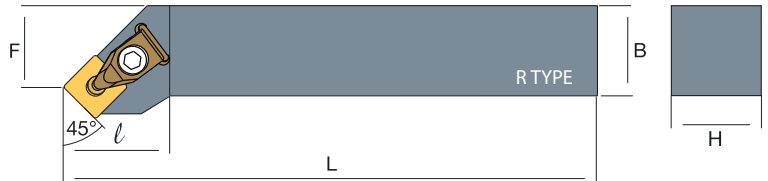
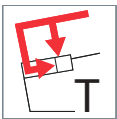

SN	DESCRIPTION 형번			STOCK 재고		DIMENSIONS 치수									
	R	L	H	B	L	F									
SN 1204	TSSNR/L	2020	K12	●	●	20	20	125	25	ST-SHSN12	ST-SC0410	ST-CS001	ST-SPR04	ST-SC630	ST-WR0030
		2525	M12	●	●	25	25	150	32	ST-SHSN12	ST-SC0410	ST-CS001	ST-SPR04	ST-SC630	ST-WR0030
		3232	P12	●	●	32	32	170	40	ST-SHSN12	ST-SC0410	ST-CS001	ST-SPR04	ST-SC630	ST-WR0030
SN 1504	TSSNR/L	2525	M15	●	●	25	25	150	32	ST-SHSN15	ST-SC6169	ST-CS003	-	ST-SC6307	ST-WR0040
		3232	P15	●	●	32	32	170	40	ST-SHSN15	ST-SC6169	ST-CS003	-	ST-SC6307	ST-WR0040
		4040	S15	●	●	40	40	250	50	ST-SHSN15	ST-SC6169	ST-CS003	-	ST-SC6307	ST-WR0040

carbide

40

PCBN

86

터닝

그라운드

나사

임핀

인테셔널 드릴

엔드밀

슬리드 드릴

부품

색인표

^SPSKN

LEVER LOCK (레버락 타입) SN □□

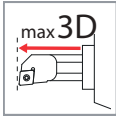
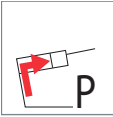
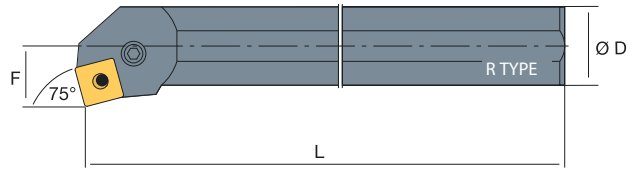

SN	DESCRIPTION 형번		STOCK 재고		DIMENSIONS 치수								
			R	L	ØD	Ød	L	F					
SN 1204	S25S	PSKNR/L	12	● ●	25	32	250	17	ST-SHSN12	ST-SPR001	ST-LV001	ST-SC820	ST-WR0030
	S32T		12	● ●	32	40	300	22	ST-SHSN12	ST-SPR001	ST-LV001	ST-SC820	ST-WR0030
	S40U		12	● ●	40	50	350	27	ST-SHSN12	ST-SPR001	ST-LV001	ST-SC820	ST-WR0030
SN 1506	S32T	PSKNR/L	15	● ●	32	40	300	22	ST-SHSN15	ST-SPR002	ST-LV002	ST-SC822	ST-WR0050
	S40U		15	● ●	40	50	350	27	ST-SHSN15	ST-SPR002	ST-LV002	ST-SC822	ST-WR0050
	S50V		15	● ●	50	63	400	35	ST-SHSN15	ST-SPR002	ST-LV002	ST-SC822	ST-WR0050

^STSKN

DOUBLE CLAMP (더블클램프 타입) SN □□

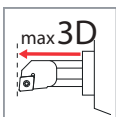
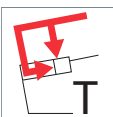
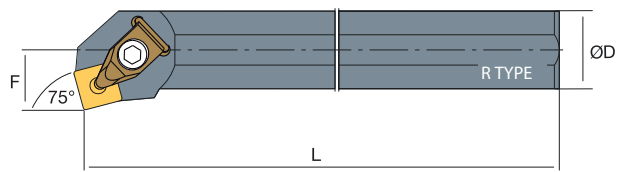
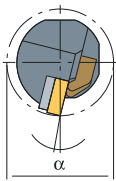

SN	DESCRIPTION 형번		STOCK 재고		DIMENSIONS 치수									
			R	L	ØD	Ød	L	F						
SN 1204	S25S	DSKNR/L	12	● ●	25	32	250	17	ST-SHSN12	ST-SC0410	ST-CS001	ST-SPR04	ST-SC523	ST-WR0030
	S32T		12	● ●	32	44	300	22	ST-SHSN12	ST-SC0410	ST-CS001	ST-SPR04	ST-SC630	ST-WR0030
	S40U		12	● ●	40	52	350	27	ST-SHSN12	ST-SC0410	ST-CS001	ST-SPR04	ST-SC630	ST-WR0030
	S50V		12	● ●	50	67	400	35	ST-SHSN12	ST-SC0410	ST-CS001	ST-SPR04	ST-SC630	ST-WR0030
SN 1506	S32T	DSKNR/L	15	● ●	32	44	300	22	ST-SHSN15	ST-SC0616	ST-CS003	-	ST-SC6307	ST-WR0040
	S40U		15	● ●	40	52	350	27	ST-SHSN15	ST-SC0616	ST-CS003	-	ST-SC6307	ST-WR0040
	S50V		15	● ●	50	67	400	35	ST-SHSN15	ST-SC0616	ST-CS003	-	ST-SC6307	ST-WR0040

적용인서트

40

PCBN

86

STFC

POSITIVE 7(인서트 여유각 7도) TC□□
 with Hole (스크류온 타입)

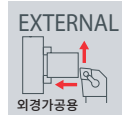
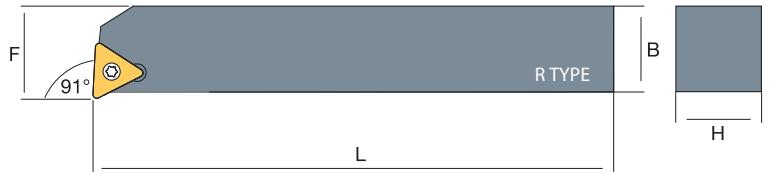

TC	DESCRIPTION 형번			STOCK 재고		DIMENSIONS 치수				←		←					
				R	L	H	B	L	F	α							
TC 0902	STFCR/L	0808	E09	●	●	08	08	70	10		ST-SC0226	ST-WRT07	-	-			
		1010	E09	●	●	10	10	70	12		ST-SC0257	ST-WRT07	-	-			
TC 1102	STFCR/L	1212	F11	●	●	12	12	80	16		ST-SC0257	ST-WRT08	-	-			
		1616	H11	●	●	16	16	100	20		ST-SC0257	ST-WRT08	-	-			
TC 16T3	STFCR/L	1616	H16	●	●	16	16	100	20		ST-SC3514	ST-WRT15	ST-SHTC16	ST-SC5011			
		2020	K16	●	●	20	20	125	25		ST-SC3514	ST-WRT15	ST-SHTC16	ST-SC5011			
		2525	M16	●	●	25	25	150	32		ST-SC3514	ST-WRT15	ST-SHTC16	ST-SC5011			
		3232	P16	●	●	32	32	170	40		ST-SC3514	ST-WRT15	ST-SHTC16	ST-SC5011			

- TURNING
- GROOVING
- THREADING
- MILLING
- DRILLING
- ENDMILLS
- DRILLS
- SPARE PARTS
- INDEX

carbide ▶ 45

PCBN ▶ 87

diamond ▶ 103

터닝

그라운드

나사

임베디드

인테그리드

엔드밀

슬리드 드릴

부품

색인표

STGC

POSITIVE 7(인서트 여유각 7도)
with Hole (스크류온 타입)

TC□□



TC	DESCRIPTION 형번			STOCK 재고		DIMENSIONS 치수				←		←					
				R	L	H	B	L	F	α	←	←					
TC 0902	STGCR/L	0808	E09	●	●	08	08	70	10			ST-SC0226	ST-WRT07	-	-		
		1010	E09	●	●	10	10	70	12			ST-SC0257	ST-WRT07	-	-		
TC 1102	STGCR/L	1212	F11	●	●	12	12	80	16			ST-SC0257	ST-WRT08	-	-		
		1616	H11	●	●	16	16	100	20			ST-SC0257	ST-WRT08	-	-		
TC 16T3	STGCR/L	1616	H16	●	●	16	16	100	20			ST-SC3514	ST-WRT15	ST-SHTC16	ST-SC5011		
		2020	K16	●	●	20	20	125	25			ST-SC3514	ST-WRT15	ST-SHTC16	ST-SC5011		
		2525	M16	●	●	25	25	150	32			ST-SC3514	ST-WRT15	ST-SHTC16	ST-SC5011		
		3232	P16	●	●	32	32	170	40			ST-SC3514	ST-WRT15	ST-SHTC16	ST-SC5011		

적용인서트 ▶ 45

PCBN ▶ 87

다이아몬드 ▶ 103

STJC

POSITIVE 7(인서트 여유각 7도) with Hole (스크류온 타입) **TC**□□

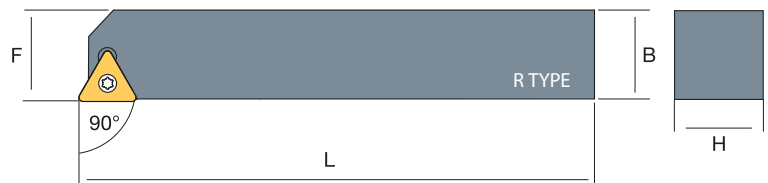

TC	DESCRIPTION 형번			STOCK 재고		DIMENSIONS 치수				←		←				
				R	L	H	B	L	F	α						
TC 0902	STJCR/L	0808	E09	●	●	08	08	70	10		ST-SC0226	ST-WRT07	-	-		
		1010	E09	●	●	10	10	70	12		ST-SC0257	ST-WRT07	-	-		
TC 1102	STJCR/L	1212	F11	●	●	12	12	80	16		ST-SC0257	ST-WRT08	-	-		
		1616	H11	●	●	16	16	100	20		ST-SC0257	ST-WRT08	-	-		
TC 16T3	STJCR/L	1616	H16	●	●	16	16	100	20		ST-SC3514	ST-WRT15	ST-SHTC16	ST-SC5011		
		2020	K16	●	●	20	20	125	25		ST-SC3514	ST-WRT15	ST-SHTC16	ST-SC5011		
		2525	M16	●	●	25	25	150	32		ST-SC3514	ST-WRT15	ST-SHTC16	ST-SC5011		
		3232	P16	●	●	32	32	170	40		ST-SC3514	ST-WRT15	ST-SHTC16	ST-SC5011		

TURNING

GROOVING

THREADING

MILLING

DRILLING

ENDMILLS

DRILLS

SPARE PARTS

INDEX

carbide

45

PCBN

87

diamond

103

^SSTFC

POSITIVE 7(인서트 여유각 7도) with Hole (스크류온 타입) **TC** □□

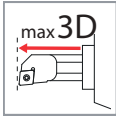
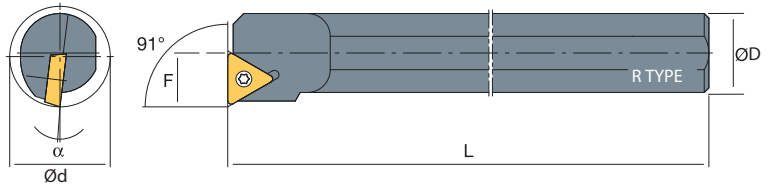

TC	DESCRIPTION 형번				STOCK 재고		DIMENSIONS 치수				←		←				
					R	L	ØD	Ød	L	F							
TC 06T1	S06K	STFCR/L	06	●	●	10	>08	125	04			ST-SC0204	ST-WRT06	-	-		
TC 0902	S10K	STFCR/L	09	●	●	10	>13	125	07			ST-SC0226	ST-WRT07	-	-		
	S12K		09	●	●	12	>17	125	09			ST-SC0226	ST-WRT07	-	-		
TC 1102	S10K	STFCR/L	11	●	●	10	>13	125	07			ST-SC0257	ST-WRT08	-	-		
	S12K		11	●	●	12	>17	125	09			ST-SC0257	ST-WRT08	-	-		
	S16P		11	●	●	16	>21	170	11			ST-SC0257	ST-WRT08	-	-		
	S20R		11	●	●	20	>25	200	13			ST-SC0257	ST-WRT08	-	-		
TC 16T3	S16P	STFCR/L	16	●	●	16	>21	170	11			ST-SC3511	ST-WRT15	-	-		
	S20R		16	●	●	20	>25	200	13			ST-SC3511	ST-WRT15	-	-		
	S25S		16	●	●	25	>32	250	17			ST-SC3514	ST-WRT15	ST-SHTC16	ST-SC5011		
	S32T		16	●	●	32	>40	300	22			ST-SC3514	ST-WRT15	ST-SHTC16	ST-SC5011		
	S40T		16	●	●	40	>50	350	27			ST-SC3514	ST-WRT15	ST-SHTC16	ST-SC5011		

적용인서트 ▶ 45

PCBN ▶ 87

다이아몬드 ▶ 103

STUC

POSITIVE 7(인서트 여유각 7도) with Hole (스크류온 타입) **TC** □ □

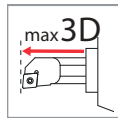
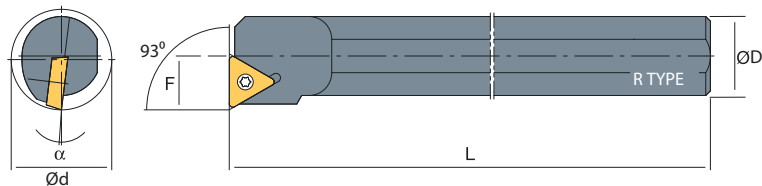

TC	DESCRIPTION 형번			STOCK 재고		DIMENSIONS 치수				←		←			
				R	L	ØD	Ød	L	F						
TC 0902	S10K	STUCR/L	09	●	●	10	>13	125	07	ST-SC0226	ST-WRT07	-	-		
	S12K		09	●	●	12	>17	125	09	ST-SC0226	ST-WRT07	-	-		
TC 1102	S10K	STUCR/L	11	●	●	10	>13	125	07	ST-SC0257	ST-WRT08	-	-		
	S12K		11	●	●	12	>17	125	09	ST-SC0257	ST-WRT08	-	-		
	S16P		11	●	●	16	>21	170	11	ST-SC0257	ST-WRT08	-	-		
	S20R		11	●	●	20	>25	200	13	ST-SC0257	ST-WRT08	-	-		
TC 16T3	S16P	STUCR/L	16	●	●	16	>21	170	11	ST-SC3511	ST-WRT15	-	-		
	S20R		16	●	●	20	>25	200	13	ST-SC3511	ST-WRT15	-	-		
	S25S		16	●	●	25	>32	250	17	ST-SC3514	ST-WRT15	ST-SHTC16	ST-SC5011		
	S32T		16	●	●	32	>40	300	22	ST-SC3514	ST-WRT15	ST-SHTC16	ST-SC5011		
	S40T		16	●	●	40	>50	350	27	ST-SC3514	ST-WRT15	ST-SHTC16	ST-SC5011		

carbide ▶ 45

PCBN ▶ 87

diamond ▶ 103



TURNING
GROOVING
THREADING
MILLING
DRILLING
ENDMILLS
DRILLS
SPARE PARTS
INDEX

^sST-C

POSITIVE 7(인서트 여유각 7도) with Hole (스크류온 타입) **TC** □□

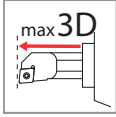
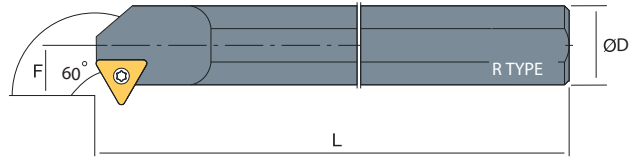
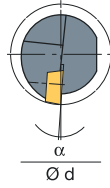

TC	DESCRIPTION 형번			STOCK 재고		DIMENSIONS 치수										
				R	L	ØD	Ød	L	F							
TC 0902	S12K	ST-CR/L	09	●	●	12	>17	125	09		ST-SC0226	ST-WRT07	-	-		
	S12K	ST-CR/L	11	●	●	12	>17	125	09		ST-SC0257	ST-WRT08	-	-		
TC 1102	S16P		11	●	●	16	>21	170	11		ST-SC0257	ST-WRT08	-	-		
	S20R		11	●	●	20	>25	200	13		ST-SC0257	ST-WRT08	-	-		
TC 16T3	S16P	ST-CR/L	16	●	●	16	>21	170	11		ST-SC3511	ST-WRT15	-	-		
	S20R		16	●	●	20	>25	200	13		ST-SC3514	ST-WRT15	ST-SHTC16	ST-SC5011		
	S25S		16	●	●	25	>32	250	17		ST-SC3514	ST-WRT15	ST-SHTC16	ST-SC5011		
	S32T		16	●	●	32	>40	300	22		ST-SC3514	ST-WRT15	ST-SHTC16	ST-SC5011		
	S40T		16	●	●	40	>50	350	27		ST-SC3514	ST-WRT15	ST-SHTC16	ST-SC5011		

적용인서트 ▶ 45

PCBN ▶ 87

다이아몬드 ▶ 103

C STFC

POSITIVE 7(인서트 여유각 7도) with Hole (스크류온 타입) **TC** □□

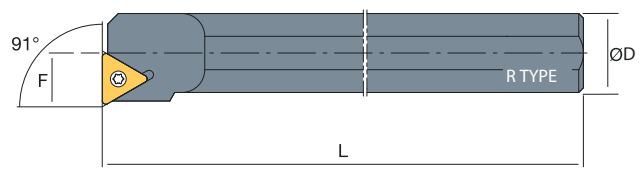
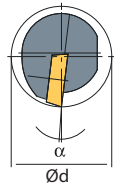
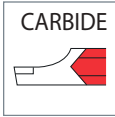
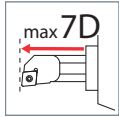

TC	DESCRIPTION 형번			STOCK 재고		DIMENSIONS 치수				ST-SC02555		ST-WRT08			
				R	L	ØD	Ød	L	F						
TC 1102	C10L	STFCR/L	11	●	●	10	>12	160	09			-	-		
	C12Q		11	●	●	12	>16	180	11	ST-SC02555	ST-WRT08	-	-		
	C16X		11	●	●	16	>20	220	15	ST-SC02555	ST-WRT08	-	-		
	C20S		11	●	●	20	>25	250	19	ST-SC02555	ST-WRT08	-	-		
	C25T		11	●	●	25	>32	300	24	ST-SC02555	ST-WRT08	-	-		

C STFP

POSITIVE 11(인서트 여유각 11도) with Hole (스크류온 타입) **TP** □□

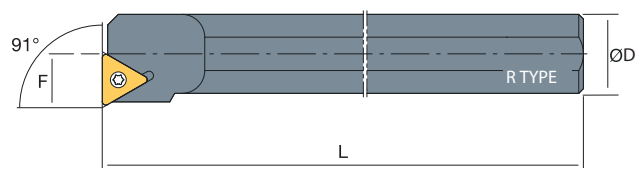
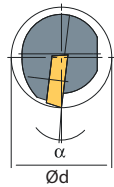
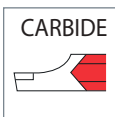
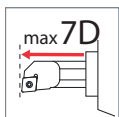

TP	DESCRIPTION 형번			STOCK 재고		DIMENSIONS 치수				ST-SC02245		ST-WRT06			
				R	L	ØD	Ød	L	F						
TP 0804	C08L	STFPR/L	08	●	●	08	>10	140	04			-	-		
TP 1103	C10N	STFPR/L	11	●	●	10	>12	160	09	ST-SC02555	ST-WRT08	-	-		
	C12Q		11	●	●	12	>16	180	11	ST-SC0352	ST-WRT08	-	-		
	C16X		11	●	●	16	>20	220	15	ST-SC0352	ST-WRT08	-	-		
	C20S		11	●	●	20	>25	250	19	ST-SC0352	ST-WRT08	-	-		
	C25T		11	●	●	25	>32	300	24	ST-SC0352	ST-WRT08	-	-		

carbide ▶ 53

PCBN ▶ 89

diamond ▶ 105

터닝

그라운드

나사

임핀

인테셔널 드릴

엔드밀

슬리드 드릴

부품

색인표

CTJN

CLAMP ON (클램프 온 타입) **TN** □□

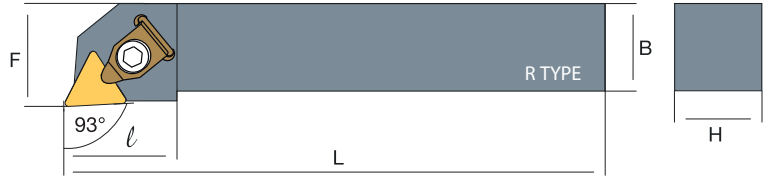

TN	DESCRIPTION 형번			STOCK 재고		DIMENSIONS 치수									
	R	L	H	B	L	F									
TN N1607	CTJNR/L	2525	M16	●	●	25	25	150	32	ST-SHTN16	ST-SC0410	ST-CS013	ST-SPR001	ST-SC630	ST-WR0030
		3232	P16	●	●	32	32	170	40	ST-SHTN16	ST-SC0410	ST-CS013	ST-SPR001	ST-SC630	ST-WR0030

MTENN

Multi Lock (멀티락 타입) **TN** □□

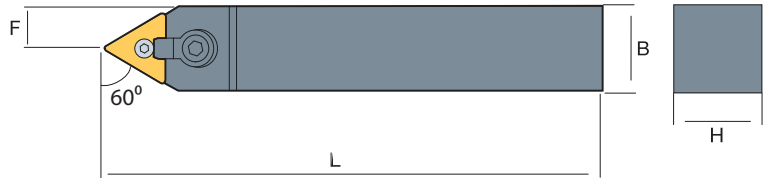

TN	DESCRIPTION 형번			STOCK 재고		DIMENSIONS 치수									
	H	B	L	F											
TN 1604	MTENN	2020	K16	●		20	20	125	10	ST-SHTN16	ST-SP001	ST-CS006	ST-SC630	ST-WR0030	
		2525	M16	●		25	25	150	12.5	ST-SHTN16	ST-SP001	ST-CS006	ST-SC630	ST-WR0030	
		3232	P16	●		32	32	170	16	ST-SHTN16	ST-SP001	ST-CS006	ST-SC630	ST-WR0030	
TN 2204	MTENN	2525	M22	●		25	25	150	12.5	ST-SHTN22	ST-SP001	ST-CS006	ST-SC630	ST-WR0030	
		3232	P22	●		32	32	170	16	ST-SHTN22	ST-SP001	ST-CS006	ST-SC630	ST-WR0030	
		4040	S22	●		40	40	250	20	ST-SHTN22	ST-SP001	ST-CS006	ST-SC630	ST-WR0030	

적용인서트 **48**

PCBN **88**

다이아몬드 **104**

MTJN

Multi Lock (멀티락 타입)

TN □□

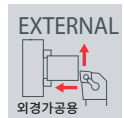
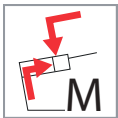





TN	DESCRIPTION 형번			STOCK 재고		DIMENSIONS 치수								
	R	L	H	B	L	F								
TN 1604	MTJNR/L	2020	K16	●	●	20	20	125	10	ST-SHTN16	ST-SP001	ST-CS006	ST-SC630	ST-WR0030
		2525	M16	●	●	25	25	150	12.5	ST-SHTN16	ST-SP001	ST-CS006	ST-SC630	ST-WR0030
		3232	P16	●	●	32	32	170	16	ST-SHTN16	ST-SP001	ST-CS006	ST-SC630	ST-WR0030
TN 2204	MTJNR/L	2525	M22	●	●	25	25	150	12.5	ST-SHTN22	ST-SP001	ST-CS006	ST-SC630	ST-WR0030
		3232	P22	●	●	32	32	170	16	ST-SHTN22	ST-SP001	ST-CS006	ST-SC630	ST-WR0030
		4040	S22	●	●	40	40	250	20	ST-SHTN22	ST-SP001	ST-CS006	ST-SC630	ST-WR0030

TTENN

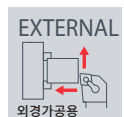
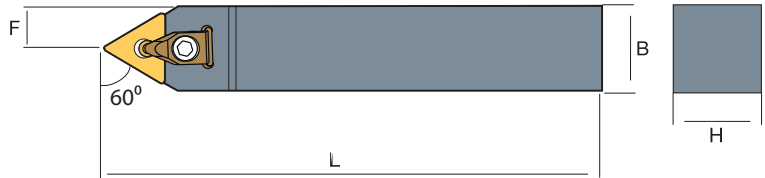
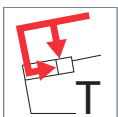
DOUBLE CLAMP
(더블클램프 타입)

TN □□



TN	DESCRIPTION 형번			STOCK 재고	DIMENSIONS 치수									
	H	B	L		F									
TN 1604	TTENN	2020	K16	●	20	20	125	10	ST-SHTN16	ST-SC0410	ST-CS002	ST-SPR04	ST-SC525	ST-WR0030
		2525	M16	●	25	25	150	12.5	ST-SHTN16	ST-SC0410	ST-CS002	ST-SPR04	ST-SC525	ST-WR0030
		3232	P16	●	32	32	170	16	ST-SHTN16	ST-SC0410	ST-CS002	ST-SPR04	ST-SC525	ST-WR0030
TN 2204	TTENN	2525	M22	●	25	25	150	12.5	ST-SHTN22	ST-SC0410	ST-CS001	ST-SPR04	ST-SC630	ST-WR0030
		3232	P22	●	32	32	170	16	ST-SHTN22	ST-SC0410	ST-CS001	ST-SPR04	ST-SC630	ST-WR0030
		4040	S22	●	40	40	250	20	ST-SHTN22	ST-SC0410	ST-CS001	ST-SPR04	ST-SC630	ST-WR0030

carbide

48

PCBN

88

diamond

104

터닝

그라운드

나사

임핀

인테셔널 드릴

엔드밀

슬리드 드릴

부품

색인표

TTJN

DOUBLE CLAMP
(더블클램프 타입)

TN □□

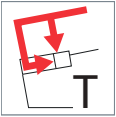

TN	DESCRIPTION 형번			STOCK 재고		DIMENSIONS 치수									
				R	L	H	B	L	F						
TN 1604	TTJNR/L	2020	K16	●	●	20	20	125	25	ST-SHTN16	ST-SC0410	ST-CS002	ST-SPR04	ST-SC525	ST-WR0030
		2525	M16	●	●	25	25	150	32	ST-SHTN16	ST-SC0410	ST-CS002	ST-SPR04	ST-SC525	ST-WR0030
		3232	P16	●	●	32	32	170	40	ST-SHTN16	ST-SC0410	ST-CS002	ST-SPR04	ST-SC525	ST-WR0030
TN 2204	TTJNR/L	2525	M22	●	●	25	25	150	32	ST-SHTN22	ST-SC0410	ST-CS001	ST-SPR04	ST-SC630	ST-WR0030
		3232	P22	●	●	32	32	170	40	ST-SHTN22	ST-SC0410	ST-CS001	ST-SPR04	ST-SC630	ST-WR0030
		4040	S22	●	●	40	40	250	50	ST-SHTN22	ST-SC0410	ST-CS001	ST-SPR04	ST-SC630	ST-WR0030

SMTUN

Multi Lock (멀티락 타입)

TN □□

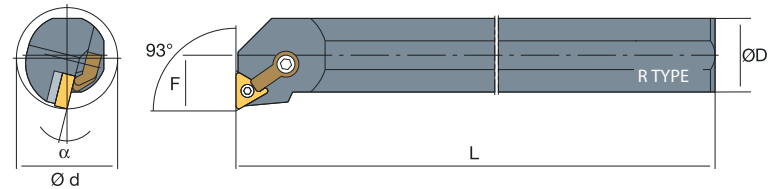
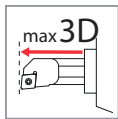
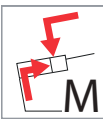

TN	DESCRIPTION 형번			STOCK 재고		DIMENSIONS 치수								
				R	L	ØD	Ød	L	F					
TN 1604	S20R	MTUNR/L	16	●	●	20	25	200	13	-	-	ST-LV002	ST-SC523	ST-WR0030
	S25S	MTUNR/L	16	●	●	25	32	250	17	ST-SHTN16	ST-SP001	ST-LV001	ST-SC630	ST-WR0030
	S32T		16	●	●	32	40	300	22	ST-SHTN16	ST-SP001	ST-LV001	ST-SC630	ST-WR0030
	S40U		16	●	●	40	50	350	27	ST-SHTN16	ST-SP001	ST-LV001	ST-SC630	ST-WR0030
TN 2204	S32T	MTUNR/L	22	●	●	32	40	300	22	ST-SHTN22	ST-SP001	ST-LV001	ST-SC630	ST-WR0030
	S40U		22	●	●	40	50	350	27	ST-SHTN22	ST-SP001	ST-LV001	ST-SC630	ST-WR0030
	S50V		22	●	●	50	63	400	35	ST-SHTN22	ST-SP001	ST-LV001	ST-SC630	ST-WR0030

적용인서트

48

PCBN

88

다이아몬드

104

S^MMTQN

Multi Lock (멀티락 타입)

TN □□

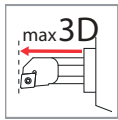
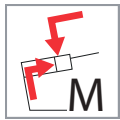
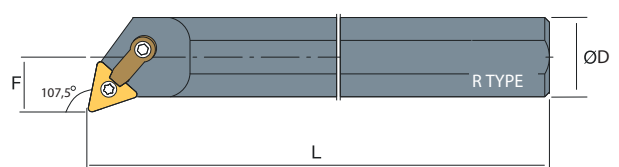
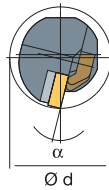

TN	DESCRIPTION 형번		STOCK 재고		DIMENSIONS 치수								
			R	L	ØD	Ød	L	F					
TN 1604	S20R	MTQNR/L	16	● ●	20	25	200	13	-	-	ST-LV002	ST-SC523	ST-WR0030
	S25S		16	● ●	25	32	250	17	ST-SHTN16	ST-SP001	ST-LV001	ST-SC630	ST-WR0030
	S32T		16	● ●	32	40	300	22	ST-SHTN16	ST-SP001	ST-LV001	ST-SC630	ST-WR0030
	S40U		16	● ●	40	50	350	27	ST-SHTN16	ST-SP001	ST-LV001	ST-SC630	ST-WR0030
TN 2204	S32T	MTQNR/L	22	● ●	32	40	300	22	ST-SHTN22	ST-SP001	ST-LV001	ST-SC630	ST-WR0030
	S40U		22	● ●	40	50	350	27	ST-SHTN22	ST-SP001	ST-LV001	ST-SC630	ST-WR0030
	S50V		22	● ●	50	63	400	35	ST-SHTN22	ST-SP001	ST-LV001	ST-SC630	ST-WR0030

S^MMT-N

Multi Lock (멀티락 타입)

TN □□

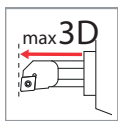
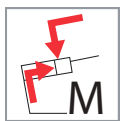
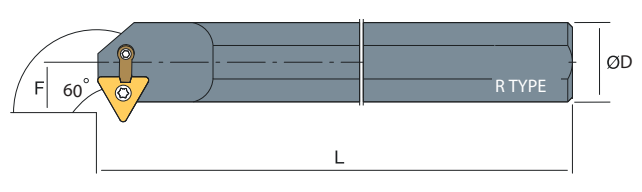
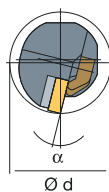

TN	DESCRIPTION 형번		STOCK 재고		DIMENSIONS 치수								
			R	L	ØD	Ød	L	F					
TN 1604	S25S	MT-NR/L	16	● ●	25	32	250	17	ST-SHTN16	ST-SP001	ST-LV001	ST-SC630	ST-WR0030
	S32T		16	● ●	32	40	300	22	ST-SHTN16	ST-SP001	ST-LV001	ST-SC630	ST-WR0030
	S40U		16	● ●	40	50	350	27	ST-SHTN16	ST-SP001	ST-LV001	ST-SC630	ST-WR0030
TN 2204	S32T	MT-NR/L	22	● ●	32	40	300	22	ST-SHTN22	ST-SP001	ST-LV001	ST-SC630	ST-WR0030
	S40U		22	● ●	40	50	350	27	ST-SHTN22	ST-SP001	ST-LV001	ST-SC630	ST-WR0030
	S50V		22	● ●	50	63	400	35	ST-SHTN22	ST-SP001	ST-LV001	ST-SC630	ST-WR0030

carbide

48

PCBN

88

diamond

104

터닝

그라운드

나사

임핀

인테서블 드릴

엔드밀

슬리드 드릴

부품

색인표

STTUN

DOUBLE CLAMP
(더블클램프 타입)

TN □□

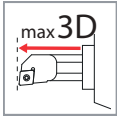
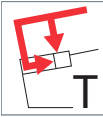
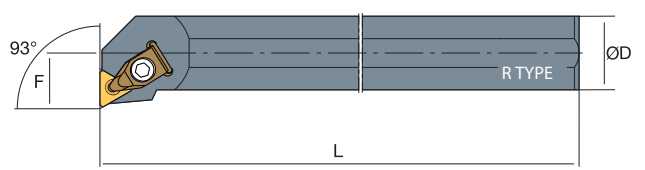
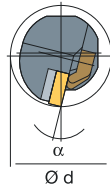

TN	DESCRIPTION 형번		STOCK 재고		DIMENSIONS 치수									
			R	L	ØD	Ød	L	F						
TN 1604	S25S	TTUNR/L	16	● ●	25	32	250	17	ST-SHTN16	ST-SC0410	ST-CS002	ST-SPR04	ST-SC523	ST-WR0030
	S32T		16	● ●	32	40	300	22	ST-SHTN16	ST-SC0410	ST-CS002	ST-SPR04	ST-SC523	ST-WR0030
TN 2204	S32T	TTUNR/L	22	● ●	32	40	300	22	ST-SHTN22	ST-SC0410	ST-CS001	ST-SPR04	ST-SC630	ST-WR0030
	S40U		22	● ●	40	50	350	27	ST-SHTN22	ST-SC0410	ST-CS001	ST-SPR04	ST-SC630	ST-WR0030
	S40V		22	● ●	50	53	400	35	ST-SHTN22	ST-SC0616	ST-CS001	ST-SPR04	ST-SC630	ST-WR0030

STT-N

DOUBLE CLAMP
(더블클램프 타입)

TN □□

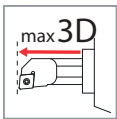
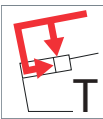
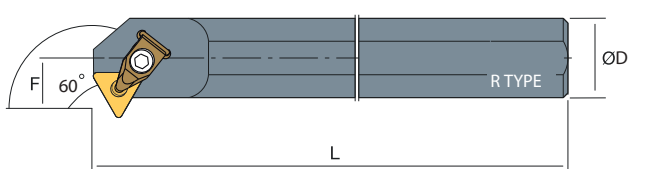
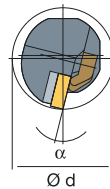

TN	DESCRIPTION 형번		STOCK 재고		DIMENSIONS 치수									
			R	L	ØD	Ød	L	F						
TN 1604	S25S	TT-NR/L	16	● ●	25	32	250	17	ST-SHTN16	ST-SC0410	ST-CS002	ST-SPR04	ST-SC523	ST-WR0030
	S32T		16	● ●	32	40	300	22	ST-SHTN16	ST-SC0410	ST-CS002	ST-SPR04	ST-SC523	ST-WR0030

적용인서트 ▶ 48





PCBN ▶ 88

다이아몬드 ▶ 104

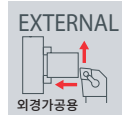
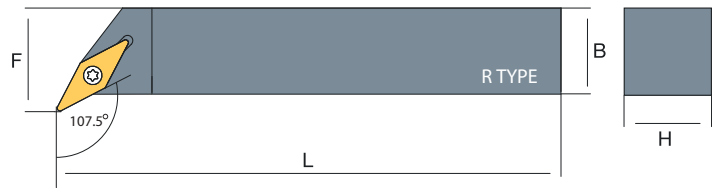
SVHB

POSITIVE 5(인서트 여유각 5도) with Hole (스크류온 타입) **VB□□**



VB	DESCRIPTION 형번			STOCK 재고		DIMENSIONS 치수				 ← 		 ← 			
				R	L	H	B	L	F						
VB 1103	SVHBR/L	1616	E11	●	●	16	16	100	20	ST-SC0257	ST-WRT08	-	-		
		2020	F11	●	●	20	20	125	25	ST-SC0257	ST-WRT08	-	-		
		2525	H11	●	●	25	25	150	32	ST-SC0257	ST-WRT15	-	-		
VB 1604	SVHBR/L	1616	H16	●	●	16	16	100	20	ST-SC3514	ST-WRT15	ST-SHVB	ST-SC5011		
		2020	K16	●	●	20	20	125	25	ST-SC3514	ST-WRT15	ST-SHVB	ST-SC5011		
		2525	M16	●	●	25	25	150	32	ST-SC3514	ST-WRT15	ST-SHVB	ST-SC5011		
		3232	P16	●	●	32	32	170	40	ST-SC0416	ST-WRT15	ST-SHVB	ST-SC5011		

TURNING

GROOVING

THREADING

MILLING

DRILLING

ENDMILLS

DRILLS

SPARE PARTS

INDEX

carbide

54

PCBN

90

diamond

106

터닝

그루브

나사

원림

인테셔널 드릴

엔드밀

슬리드 드릴

부품

색인표

SVJB

POSITIVE 5(인서트 여유각 5도) with Hole (스크류온 타입) **VB□□**

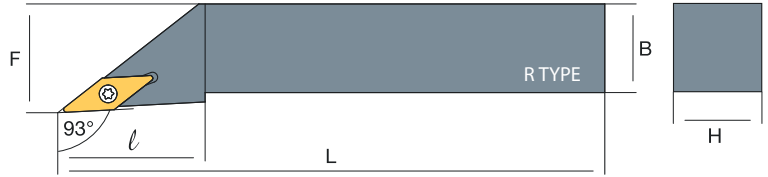

VB	DESCRIPTION 형번			STOCK 재고		DIMENSIONS 치수									
				R	L	H	B	L	F						
VB 1103	SVJBR/L	1212	F11	●	●	12	12	80	16	ST-SC0257	ST-WRT08	-	-		
		1616	H11	●	●	16	16	100	20	ST-SC0257	ST-WRT08	-	-		
		2020	K11	●	●	20	20	125	25	ST-SC0257	ST-WRT08	-	-		
		2525	M11	●	●	25	25	150	32	ST-SC0257	ST-WRT15	-	-		
VB 1604	SVJBR/L	1616	H16	●	●	16	16	100	20	ST-SC3514	ST-WRT15	ST-SHVB	ST-SC5011		
		2020	K16	●	●	20	20	125	25	ST-SC3514	ST-WRT15	ST-SHVB	ST-SC5011		
		2525	M16	●	●	25	25	150	32	ST-SC3514	ST-WRT15	ST-SHVB	ST-SC5011		
		3232	P16	●	●	32	32	170	40	ST-SC0416	ST-WRT15	ST-SHVB	ST-SC5011		

적용인서트 ▶ 54

PCBN ▶ 90





다이아몬드 ▶ 106

SVVBN

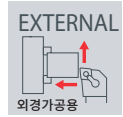
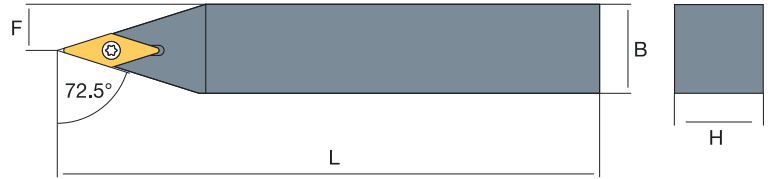
POSITIVE 5(인서트 여유각 5도) with Hole (스크류온 타입)

VB□□



VB	DESCRIPTION 형번			STOCK 재고	DIMENSIONS 치수				 ← 		 ← 			
	SVVBN	형번	형번		H	B	L	F						
VB 1103	SVVBN	1616	H11	●	16	16	100	08	ST-SC0257	ST-WRT08	-	-		
		2020	K11	●	20	20	125	10	ST-SC0257	ST-WRT08	-	-		
		2525	M11	●	25	25	150	12.5	ST-SC0257	ST-WRT08	-	-		
VB 1604	SVVBN	1616	H16	●	16	16	100	08	ST-SC0416	ST-WRT15	ST-SHVB	ST-SC5011		
		2020	K16	●	20	20	125	10	ST-SC3514	ST-WRT15	ST-SHVB	ST-SC5011		
		2525	M16	●	25	25	150	12.5	ST-SC3514	ST-WRT15	ST-SHVB	ST-SC5011		
		3232	P16	●	32	32	170	16	ST-SC3514	ST-WRT15	ST-SHVB	ST-SC5011		

TURNING

GROOVING

THREADING

MILLING

DRILLING

ENDMILLS

DRILLS

SPARE PARTS

INDEX

carbide

54

PCBN

90

diamond

106

터닝

그라운드

나사

임베디드

인테그럴 드릴

엔드밀

솔리드 드릴

부품

색인표

SVZB

POSITIVE 5(인서트 여유각 5도)
with Hole (스크류온 타입)

VB□□

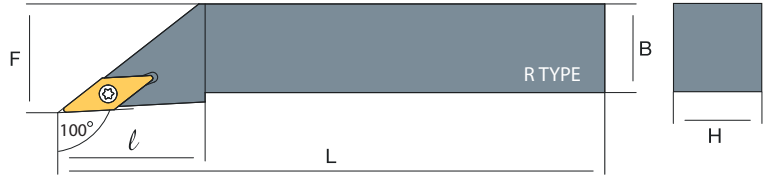

VB	DESCRIPTION 형번			STOCK 재고		DIMENSIONS 치수									
				R	L	H	B	L	F						
VB 1103	SVZBR/L	1616	H11	●	●	16	16	100	20	ST-SC0257	ST-WRT08	-	-		
		2020	K11	●	●	20	20	125	25	ST-SC0257	ST-WRT08	-	-		
		2525	M11	●	●	25	25	150	32	ST-SC0257	ST-WRT15	-	-		
VB 1604	SVZBR/L	1616	H16	●	●	16	16	100	20	ST-SC3514	ST-WRT15	ST-SHVB	ST-SC5011		
		2020	K16	●	●	20	20	125	25	ST-SC3514	ST-WRT15	ST-SHVB	ST-SC5011		
		2525	M16	●	●	25	25	150	32	ST-SC3514	ST-WRT15	ST-SHVB	ST-SC5011		
		3232	P16	●	●	32	32	170	40	ST-SC0416	ST-WRT15	ST-SHVB	ST-SC5011		

적용인서트

54

PCBN

90

다이아몬드

106

^SSVJB

POSITIVE 5(인서트 여유각 5도) with Hole (스크류온 타입) **VB**□□

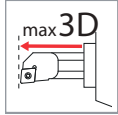
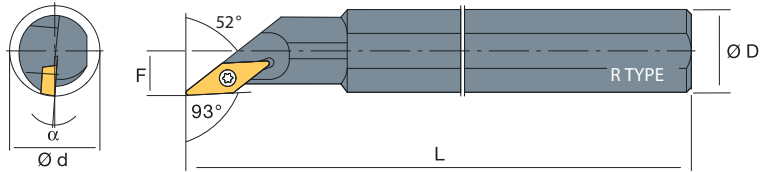

VB	DESCRIPTION 형번		STOCK 재고		DIMENSIONS 치수									
			R	L	ØD	Ød	L	F						
VB 1604	S25S	SVJBR/L	16	● ●	25	32	250	17	ST-SC0416	ST-WRT15	ST-SHVB	ST-SC5011		
	S32T		16	● ●	32	40	300	22	ST-SC3514	ST-WRT15	ST-SHVB	ST-SC5011		
	S40U		16	● ●	40	50	350	27	ST-SC3514	ST-WRT15	ST-SHVB	ST-SC5011		

^SSVQB

POSITIVE 5(인서트 여유각 5도) with Hole (스크류온 타입) **VB**□□

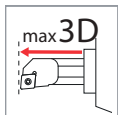
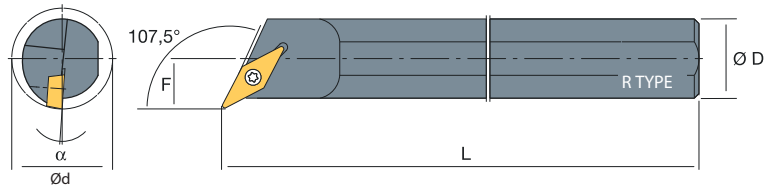

VB	DESCRIPTION 형번		STOCK 재고		DIMENSIONS 치수									
			R	L	ØD	Ød	L	F						
VB 1103	S16P	SVQBR/L	11	● ●	16	21	170	11	ST-SC0257	ST-WRT08	-	-		
	S20R		11	● ●	20	25	200	13	ST-SC0257	ST-WRT08	-	-		
VB 1604	S25S	SVQBR/L	16	● ●	25	32	250	17	ST-SC0416	ST-WRT15	ST-SHVB	ST-SC5011		
	S32T		16	● ●	32	40	300	22	ST-SC3514	ST-WRT15	ST-SHVB	ST-SC5011		
	S40U		16	● ●	40	50	350	27	ST-SC3514	ST-WRT15	ST-SHVB	ST-SC5011		

carbide ▶ 54

PCBN ▶ 90

diamond ▶ 106

터닝

그라운드

나사

임베디드

인테그럴 드릴

엔드밀

슬리드 드릴

부품

색인표

^SSVUB

POSITIVE 5(인서트 여유각 5도) with Hole (스크류온 타입) **VB□□**

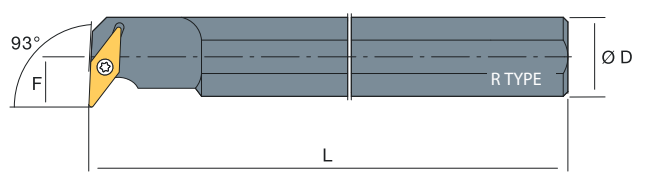
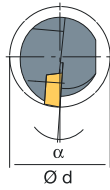
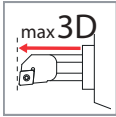

VB	DESCRIPTION 형번		STOCK 재고		DIMENSIONS 치수				←		←			
			R	L	ØD	Ød	L	F	←	←				
VB 1103	S16P	SVUBR/L	11	● ●	16	21	170	11	ST-SC0257	ST-WRT08	-	-		
	S20R		11	● ●	20	25	200	13	ST-SC0257	ST-WRT08	-	-		
VB 1604	S25S	SVUBR/L	16	● ●	25	32	250	17	ST-SC0416	ST-WRT15	ST-SHVB	ST-SC5011		
	S32T		16	● ●	32	40	300	22	ST-SC3514	ST-WRT15	ST-SHVB	ST-SC5011		
	S40U		16	● ●	40	50	350	27	ST-SC3514	ST-WRT15	ST-SHVB	ST-SC5011		

^SSVXB

POSITIVE 5(인서트 여유각 5도) with Hole (스크류온 타입) **VB□□**

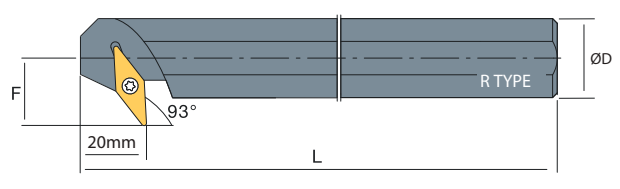
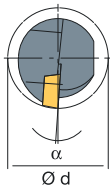
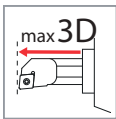

VB	DESCRIPTION 형번		STOCK 재고		DIMENSIONS 치수				←		←			
			R	L	ØD	Ød	L	F	←	←				
VB 1103	S16P	SVXBR/L	11	● ●	16	21	170	11	ST-SC0257	ST-WRT08	-	-		
	S20R		11	● ●	20	25	200	13	ST-SC0257	ST-WRT08	-	-		
VB 1604	S25S	SVXBR/L	16	● ●	25	32	250	17	ST-SC0416	ST-WRT15	ST-SHVB	ST-SC5011		
	S32T		16	● ●	32	40	300	22	ST-SC3514	ST-WRT15	ST-SHVB	ST-SC5011		
	S40U		16	● ●	40	50	350	27	ST-SC3514	ST-WRT15	ST-SHVB	ST-SC5011		

적용인서트

54

PCBN

90

다이아몬드



106

SVHC

POSITIVE 7(인서트 여유각 7도) with Hole (스크류온 타입)

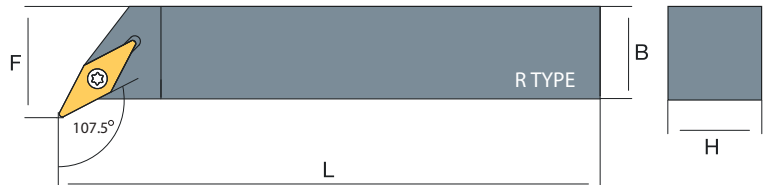
VC □ □





VC	DESCRIPTION 형번			STOCK 재고		DIMENSIONS 치수									
				R	L	H	B	L	F						
VC 1103	SVHCR/L	1616	H11	●	●	16	16	100	20	ST-SC0257	ST-WRT08	-	-		
		2020	K11	●	●	20	20	125	25	ST-SC0257	ST-WRT08	-	-		
VC 1604	SVHCR/L	2020	K16	●	●	25	25	150	32	ST-SC0257	ST-WRT15	-	-		
		2525	M16	●	●	16	16	100	20	ST-SC3514	ST-WRT15	ST-SHVC	ST-SC5011		
		3232	P16	●	●	20	20	125	25	ST-SC3514	ST-WRT15	ST-SHVC	ST-SC5011		

SVJC

POSITIVE 7(인서트 여유각 7도) with Hole (스크류온 타입)

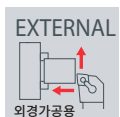
VC □ □



VC	DESCRIPTION 형번			STOCK 재고		DIMENSIONS 치수									
				R	L	H	B	L	F						
VC 1103	SVJCR/L	1616	H11	●	●	16	16	100	20	ST-SC0257	ST-WRT08	-	-		
		2020	K11	●	●	20	20	125	25	ST-SC0257	ST-WRT08	-	-		
VC 1604	SVJCR/L	2020	K16	●	●	25	25	150	32	ST-SC0257	ST-WRT15	-	-		
		2525	M16	●	●	16	16	100	20	ST-SC3514	ST-WRT15	ST-SHVC	ST-SC5011		
		3232	P16	●	●	20	20	125	25	ST-SC3514	ST-WRT15	ST-SHVC	ST-SC5011		

carbide

56

PCBN

91

diamond

107

터닝

그라운드

나사

임핀

인테셔널 드릴

엔드밀

슬리드 드릴

부품

색인표

^sSVUC

POSITIVE 7(인서트 여유각 7도) with Hole (스크류온 타입) **VC** □ □

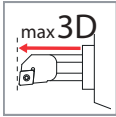
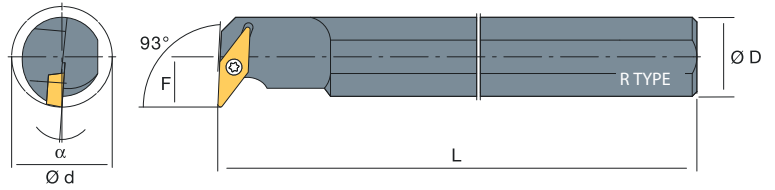

VC	DESCRIPTION 형번		STOCK 재고		DIMENSIONS 치수										
			R	L	ØD	Ød	L	F							
VC 1103	S16P	SVUCR/L	11	●	●	16	21	170	11	ST-SC0257	ST-WRT08	-	-		
	S20R		11	●	●	20	25	200	13	ST-SC0257	ST-WRT08	-	-		
VC 1604	S25S	SVUCR/L	16	●	●	25	32	250	17	ST-SC0416	ST-WRT15	ST-SHVC	ST-SC5011		
	S32T		16	●	●	32	40	300	22	ST-SC3514	ST-WRT15	ST-SHVC	ST-SC5011		
	S40U		16	●	●	40	50	350	27	ST-SC3514	ST-WRT15	ST-SHVC	ST-SC5011		

^sSVQC

POSITIVE 7(인서트 여유각 7도) with Hole (스크류온 타입) **VC** □ □

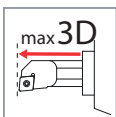
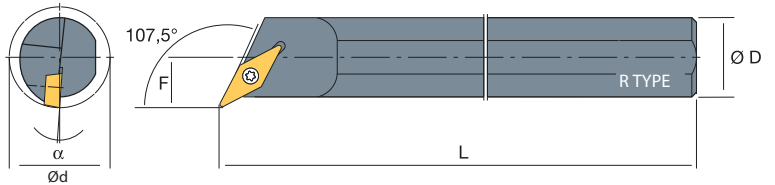

VC	DESCRIPTION 형번		STOCK 재고		DIMENSIONS 치수										
			R	L	ØD	Ød	L	F							
VC 1103	S16P	SVQCR/L	11	●	●	16	21	170	11	ST-SC0257	ST-WRT08	-	-		
	S20R		11	●	●	20	25	200	13	ST-SC0257	ST-WRT08	-	-		
VC 1604	S25S	SVQCR/L	16	●	●	25	32	250	17	ST-SC0416	ST-WRT15	ST-SHVC	ST-SC5011		
	S32T		16	●	●	32	40	300	22	ST-SC3514	ST-WRT15	ST-SHVC	ST-SC5011		
	S40U		16	●	●	40	50	350	27	ST-SC3514	ST-WRT15	ST-SHVC	ST-SC5011		

적용인서트 ▶ 56

PCBN ▶ 91

다이아몬드 ▶ 107

TVHN

DOUBLE CLAMP
 (더블클램프 타입)

VN □□

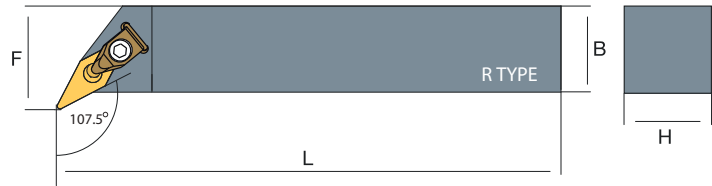
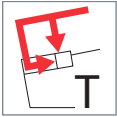

VN	DESCRIPTION 형번			STOCK 재고		DIMENSIONS 치수									
				R	L	H	B	L	F						
VN 1604	TVHNR/L	2020	K16	●	●	20	20	125	25	ST-SHVN16	ST-SC0410	ST-CS005	ST-SPR04	ST-SC630	ST-WR0030
		2525	M16	●	●	25	25	150	32	ST-SHVN16	ST-SC0410	ST-CS005	ST-SPR04	ST-SC630	ST-WR0030
		3232	P16	●	●	32	32	170	40	ST-SHVN16	ST-SC0410	ST-CS005	ST-SPR04	ST-SC630	ST-WR0030

TVJN

DOUBLE CLAMP
 (더블클램프 타입)

VN □□

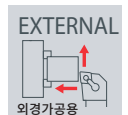
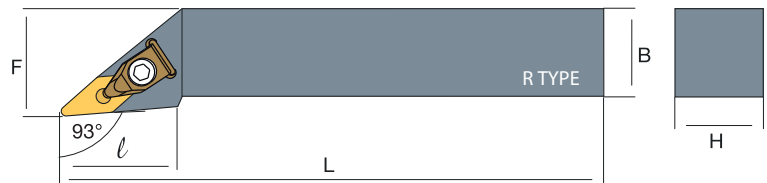
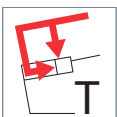

VN	DESCRIPTION 형번			STOCK 재고		DIMENSIONS 치수									
				R	L	H	B	L	F						
VN 1604	TVJNR/L	2020	K16	●	●	20	20	125	25	ST-SHVN16	ST-SC0410	ST-CS005	ST-SPR04	ST-SC630	ST-WR0030
		2525	M16	●	●	25	25	150	32	ST-SHVN16	ST-SC0410	ST-CS005	ST-SPR04	ST-SC630	ST-WR0030
		3232	P16	●	●	32	32	170	40	ST-SHVN16	ST-SC0410	ST-CS005	ST-SPR04	ST-SC630	ST-WR0030
		4040	P16	●	●	40	40	250	50	ST-SHVN16	ST-SC0410	ST-CS005	ST-SPR04	ST-SC630	ST-WR0030

carbide

58

PCBN

92

터닝

그라운드

나사

임핀

인테셔널 드릴

엔드밀

슬리드 드릴

부품

색인표

TWNN

DOUBLE CLAMP
(더블클램프 타입)

VN □□

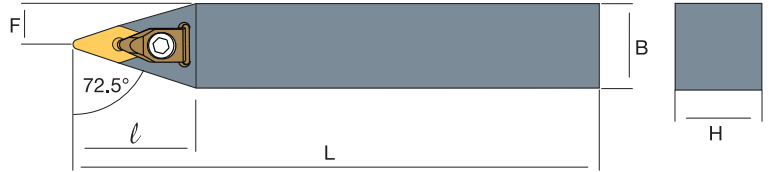
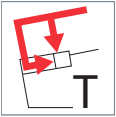

VN	DESCRIPTION 형번			STOCK 재고	DIMENSIONS 치수									
					H	B	L	F						
VN 1604	TVNN	2020	K16	●	20	20	125	25	ST-SHVN16	ST-SC0410	ST-CS005	ST-SPR04	ST-SC630	ST-WR0030
		2525	M16	●	25	25	150	32	ST-SHVN16	ST-SC0410	ST-CS005	ST-SPR04	ST-SC630	ST-WR0030
		3232	P16	●	32	32	170	40	ST-SHVN16	ST-SC0410	ST-CS005	ST-SPR04	ST-SC630	ST-WR0030
		4040	P16	●	40	40	250	50	ST-SHVN16	ST-SC0410	ST-CS005	ST-SPR04	ST-SC630	ST-WR0030

STVUN

DOUBLE CLAMP
(더블클램프 타입)

VN □□

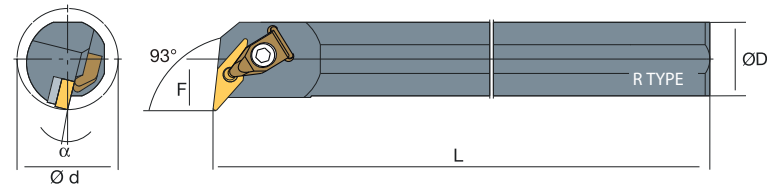
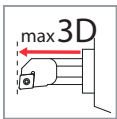
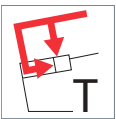

VN	DESCRIPTION 형번			STOCK 재고		DIMENSIONS 치수									
				R	L	ØD	Ød	L	F						
VN 1604	S25S	TVUNR/L	16	●	●	25	32	250	17	ST-SHTN16	ST-SC0410	ST-CS005	ST-SPR04	ST-SC630	ST-WR0030
	S32T		16	●	●	32	40	300	22	ST-SHTN16	ST-SC0410	ST-CS005	ST-SPR04	ST-SC630	ST-WR0030
	S40U		16	●	●	50	50	400	27	ST-SHTN22	ST-SC0410	ST-CS005	ST-SPR04	ST-SC630	ST-WR0030

적용인서트

58

PCBN

92

^SSWLC

POSITIVE 7(인서트 여유각 7도)
with Hole (스크류온 타입) **WC** □ □

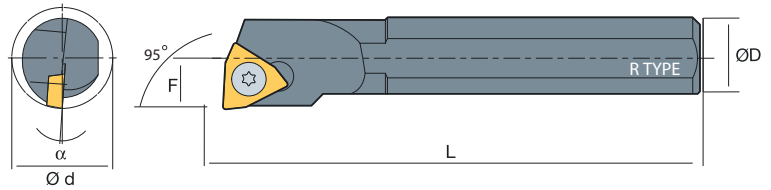
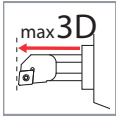

WC	DESCRIPTION 형번		STOCK 재고		DIMENSIONS 치수				←		←			
			R	L	ØD	Ød	L	F						
WC 0302	S068H	SWLCR/L	16	● ●	08	08	100	04	ST-SC0257	ST-WR0030	-	-		
	S081K		16	● ●	10	10	125	07	ST-SC0257	ST-WR0030	-	-		

TURNING

GROOVING

THREADING

MILLING

DRILLING

ENDMILLS

DRILLS

SPARE PARTS

INDEX

터너

그라운드

나사

임핀

인테리블 드릴

엔드밀

슬리드 드릴

부품

색인표

MWDN

Multi Lock (멀티락 타입)

WN□□

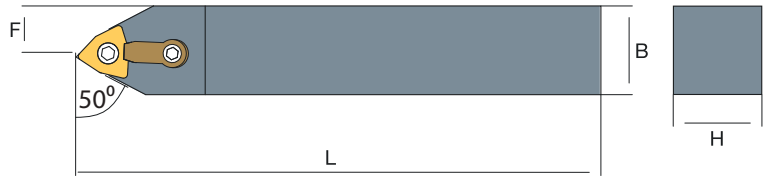

WN	DESCRIPTION 형번			STOCK 재고		DIMENSIONS 치수				←		←		↙
				R	L	H	B	L	F	←	←			
WN 0604	MWDNR/L	1616	H06	●	●	16	16	100	08	-	-	ST-CS009	ST-SM525	ST-WR0030
		2020	K06	●	●	20	20	125	10	-	-	ST-CS009	ST-SM525	ST-WR0030
		2525	M06	●	●	25	25	150	12.5	-	-	ST-CS009	ST-SM525	ST-WR0030
WN 0804	MWDNR/L	2020	K08	●	●	20	20	125	10	ST-SHWN08	ST-SC0410	ST-CS008	ST-SM630	ST-WR0030
		2525	M08	●	●	25	25	150	12.5	ST-SHWN08	ST-SC0410	ST-CS008	ST-SM630	ST-WR0030
		3232	P08	●	●	32	32	170	16	ST-SHWN08	ST-SC0410	ST-CS008	ST-SM630	ST-WR0030

MWLN

Multi Lock (멀티락 타입)

WN□□

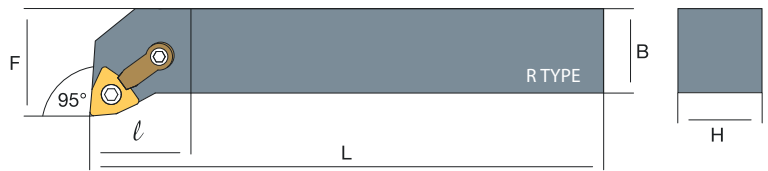

WN	DESCRIPTION 형번			STOCK 재고		DIMENSIONS 치수				←		←		↙
				R	L	H	B	L	F	←	←			
WN 0604	MWLNLR/L	1616	H06	●	●	16	16	100	20	-	-	ST-CS009	ST-SC525	ST-WR0030
		2020	K06	●	●	20	20	125	25	-	-	ST-CS009	ST-SC525	ST-WR0030
		2525	M06	●	●	25	25	150	32	-	-	ST-CS009	ST-SC525	ST-WR0030
WN 0804	MWLNLR/L	2020	K08	●	●	20	20	125	25	ST-SHWN08	ST-SCV3506	ST-CS008	ST-SC630	ST-WR0030
		2525	M08	●	●	25	25	150	32	ST-SHWN08	ST-SCV3506	ST-CS008	ST-SC630	ST-WR0030
		3232	P08	●	●	32	32	170	40	ST-SHWN08	ST-SCV3506	ST-CS008	ST-SC630	ST-WR0030

적용인서트

61

PCBN

93

다이아몬드

108

PWLN

LEVER LOCK (레버락 타입) WN□□

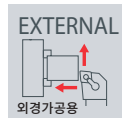

WN	DESCRIPTION 형번			STOCK 재고		DIMENSIONS 치수								
				R	L	H	B	L	F					
WN 0804	PWLN/R/L	2020	K08	●	●	20	20	125	25	ST-SHWN08	ST-SPR001	ST-LV001	ST-SC820	ST-WR0030
		2525	M08	●	●	25	25	150	32	ST-SHWN08	ST-SPR001	ST-LV001	ST-SC820	ST-WR0030
		3232	P08	●	●	32	32	170	40	ST-SHWN08	ST-SPR001	ST-LV001	ST-SC820	ST-WR0030
		4040	S08	●	●	40	40	250	50	ST-SHWN08	ST-SPR001	ST-LV001	ST-SC820	ST-WR0030

TWLN

DOUBLE CLAMP (더블클램프 타입) WN□□

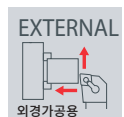
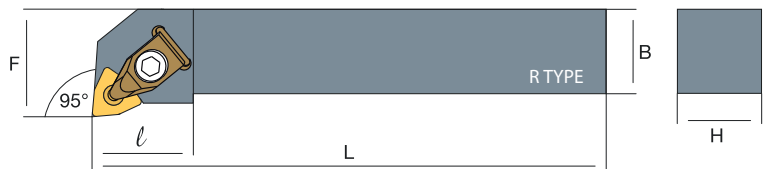
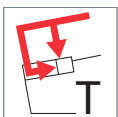

VN	DESCRIPTION 형번			STOCK 재고		DIMENSIONS 치수									
				R	L	H	B	L	F						
WN 0604	TWLN/R/L	1616	H06	●	●	16	16	100	20	-	-	ST-CS002	ST-SPR04	ST-SC523	ST-WR0030
		2020	K06	●	●	20	20	125	25	-	-	ST-CS002	ST-SPR04	ST-SC523	ST-WR0030
		2525	M06	●	●	25	25	150	32	-	-	ST-CS002	ST-SPR04	ST-SC523	ST-WR0030
WN 0804	TWLN/R/L	2020	K08	●	●	20	20	125	25	-	-	ST-CS001	ST-SPR04	ST-SC523	ST-WR0030
		2525	M08	●	●	25	25	150	32	ST-SHWN08	ST-SC0410	ST-CS001	ST-SPR04	ST-SC630	ST-WR0030
		3232	P08	●	●	32	32	170	40	ST-SHWN08	ST-SC0410	ST-CS001	ST-SPR04	ST-SC630	ST-WR0030
		4040	S08	●	●	40	40	250	50	ST-SHWN08	ST-SC0410	ST-CS001	ST-SPR04	ST-SC630	ST-WR0030

carbide

61

PCBN

93

diamond

108

터닝

그라운드

나사

임핀

인테서블 드릴

엔드밀

슬리드 드릴

부품

색인표

S^MMWLN

Multi Lock (멀티락 타입)

WN□□

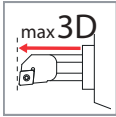
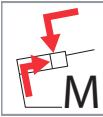
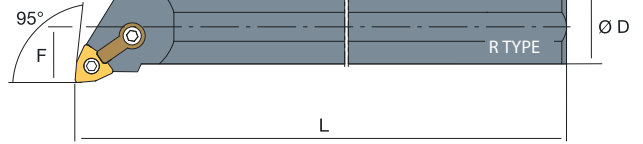
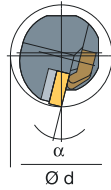

WN	DESCRIPTION 형번		STOCK 재고		DIMENSIONS 치수										
			R	L	ØD	Ød	L	F							
WN 0604	S25S	MWLN/R/L	06	● ●	16	21	170	11			ST-CS009	ST-SM525	ST-WR0030		
	S32T		06	● ●	20	25	200	13			ST-CS009	ST-SM525	ST-WR0030		
	S40U		06	● ●	25	32	350	17			ST-CS009	ST-SM525	ST-WR0030		
WN 0804	S25S	MWLN/R/L	08	● ●	25	32	250	17	ST-SHWN08	ST-SCV0410	ST-CS008	ST-SM630	ST-WR0030		
	S32T		08	● ●	32	40	300	22	ST-SHWN08	ST-SCV0410	ST-CS008	ST-SM630	ST-WR0030		
	S40U		08	● ●	40	50	350	27	ST-SHWN08	ST-SCV0410	ST-CS008	ST-SM630	ST-WR0030		
	S50V		08	● ●	50	63	400	35	ST-SHWN08	ST-SCV0410	ST-CS008	ST-SM630	ST-WR0030		

S^PPWLN

LEVER LOCK (레버락 타입)

WN□□

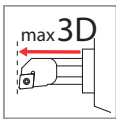
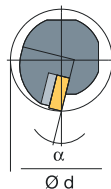

WN	DESCRIPTION 형번		STOCK 재고		DIMENSIONS 치수										
			R	L	ØD	Ød	L	F							
WN 0804	S25S	PWLN/R/L	08	● ●	25	32	250	17	ST-SHWN08	ST-SCV0410	ST-CS001	ST-SM630	ST-WR0030		
	S32T		08	● ●	32	40	300	22	ST-SHWN08	ST-SCV0410	ST-CS001	ST-SM630	ST-WR0030		
	S40U		08	● ●	40	50	350	27	ST-SHWN08	ST-SCV0410	ST-CS001	ST-SM630	ST-WR0030		
	S50V		08	● ●	50	63	400	35	ST-SHWN08	ST-SCV0410	ST-CS001	ST-SM630	ST-WR0030		

적용인서트

61

PCBN

93

다이아몬드

108

STWLN

DOUBLE CLAMP
(더블클램프 타입)

WN□□

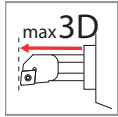
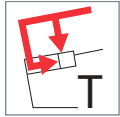
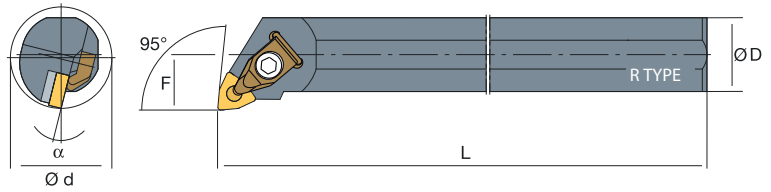

TURNING

GROOVING

THREADING

MILLING

DRILLING

ENDMILLS

DRILLS

SPARE PARTS

INDEX

WN	DESCRIPTION 형번		STOCK 재고		DIMENSIONS 치수									
			R	L	ØD	Ød	L	F						
WN 0604	S25S	TWLNLR/L	06	● ●	25	32	250	17	-	-	ST-CS009	-	ST-SC525	ST-WR0030
	S32T		06	● ●	32	40	300	22	-	-	ST-CS009		ST-SC525	ST-WR0030
WN 0804	S25S	TWLNLR/L	08	● ●	25	32	250	17	ST-SHWN08	ST-SC0410	ST-CS008	ST-SPR04	ST-SC630	ST-WR0030
	S32T		08	● ●	32	40	300	22	ST-SHWN08	ST-SC0410	ST-CS008	ST-SPR04	ST-SC630	ST-WR0030
	S40U		08	● ●	40	37	350	27	ST-SHWN08	ST-SC0410	ST-CS008	ST-SPR04	ST-SC630	ST-WR0030
	S50V		08	● ●	50	47	400	35	ST-SHWN08	ST-SC0410	ST-CS008	ST-SPR04	ST-SC630	ST-WR0030

carbide

61

PCBN

93

diamond

108

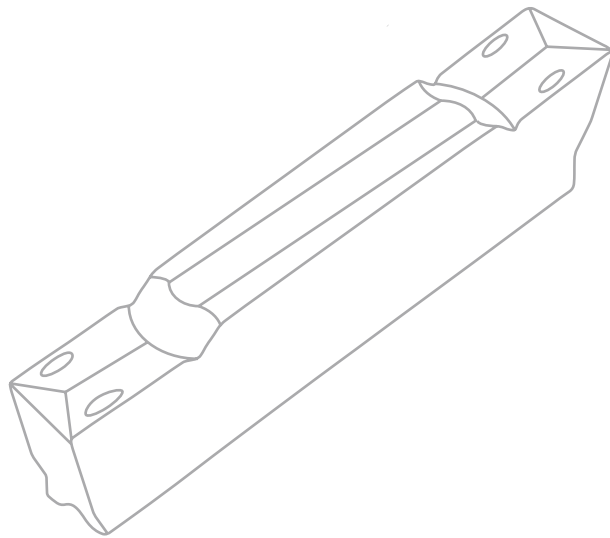

GROOVING/

인서트 carbide /193
홀더 / 보링바 holders /205

GROOVING / carbide

그루빙 / 인서트

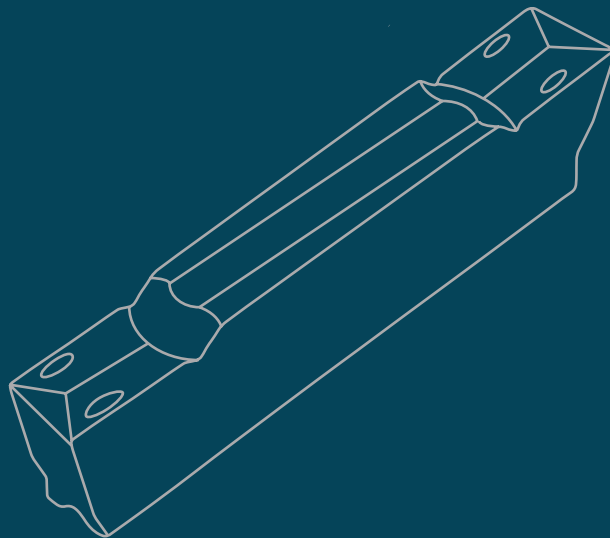

Grade / 재종

ISO DIN 513	K					P					M					N				
	K01	K10	K20	K30	K40	P01	P10	P20	P30	P40	M01	M10	M20	M30	M40	N01	N10	N20	N30	N40
CARBIDE CVD 코팅	TC5525P					TC5525P														
CARBIDE PVD PVD 코팅	TP4505					TP5025					TP0525									
						TP6525P					TP6525P									
						TP0535					TP0535									
CARBIDE UNCOATED 초경																TU4005				

GROOVING 그루빙

Range / 재종 테이블 ISO **P** **M** **K**

Grades / 재종

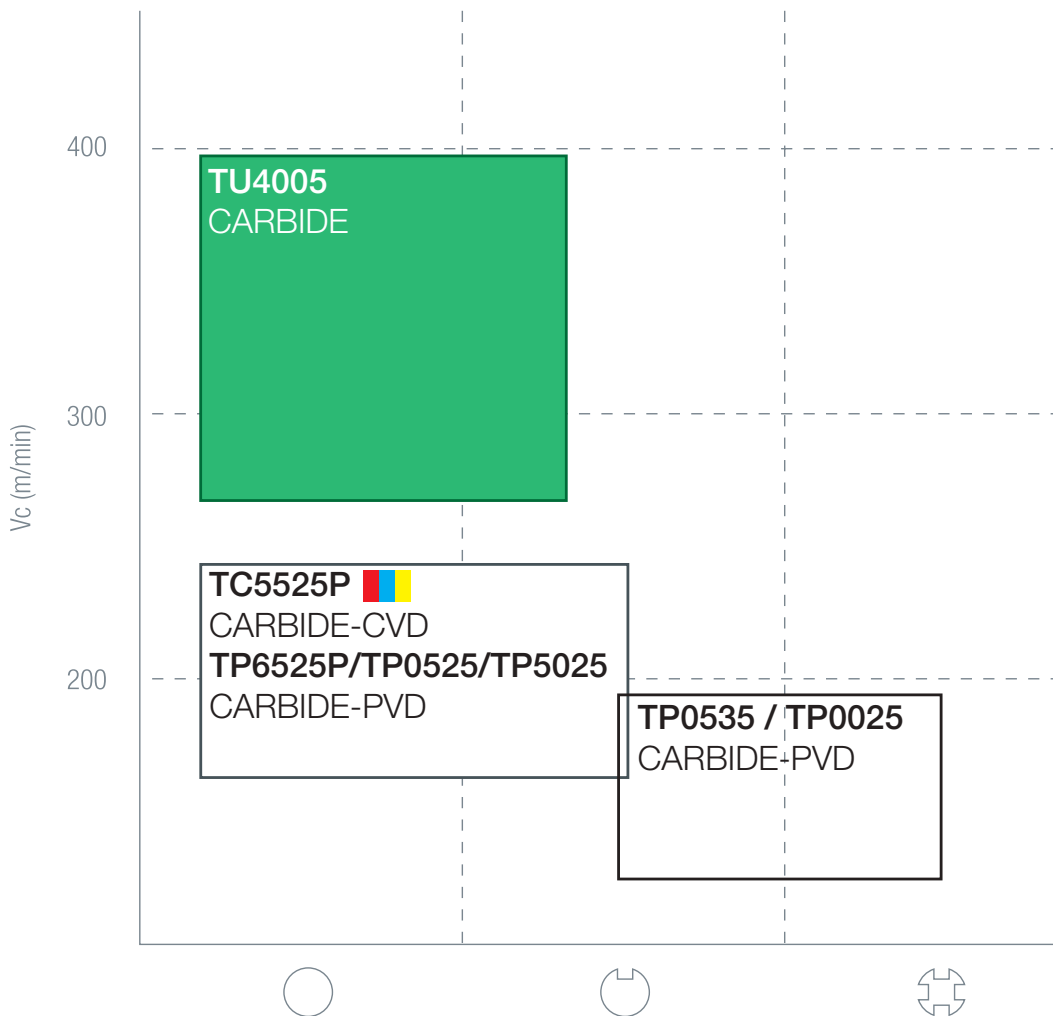

TURNING

GROOVING

THREADING

MILLING

DRILLING

ENDMILLS

DRILLS

SPARE PARTS

INDEX

MGMN-C

PARTING & GROOVING
절단 & 그루빙

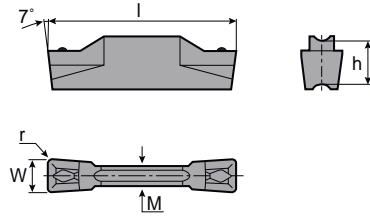

DESCRIPTION
형번

DIMENSIONS
형번

CARBIDE 재종

TC5135	TP0525	TP0535	TP6525P	TP4505	
					W
●	●	●	●		
●	●	●	●		
●	●	●	●		
●	●	●	●		
●	●	●	●		
●	●	●	●		
●	●	●	●		



MGMN150-C	1.5	0.15	16.0	1.2	3.5	
MGMN200-C	2.0	0.2	16.0	1.2	3.5	-
MGMN250-C	2.5	0.2	18.5	2.0	3.85	-
MGMN300-C	3.0	0.4	21.0	2.35	4.8	-
MGMN400-C	4.0	0.4	21.0	3.3	4.8	-
MGMN500-C	5.0	0.8	26.0	4.1	5.8	-
MGMN600-C	6.0	0.8	26.0	5.0	5.8	

MGMR-J

PARTING & GROOVING
절단 & 그루빙

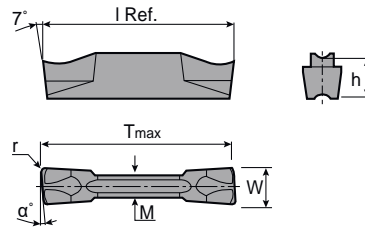

DESCRIPTION
형번

DIMENSIONS
형번

CARBIDE 재종

TC5135	TP0525	TP0535	TP6525P	TP4505	
					W
●	●	●	●		
●	●	●	●		



MGMR200J-15D	2.0	0.2	16.0	1.2	3.5	15
MGMR300J-15D	3.0	0.4	21.0	2.35	4.8	15

GROOVING 그루빙

TURNING

GROOVING

THREADING

MILLING

DRILLING

ENDMILLS

DRILLS

SPARE PARTS

INDEX

MGMN-J

PARTING & GROOVING
절단 & 그루빙

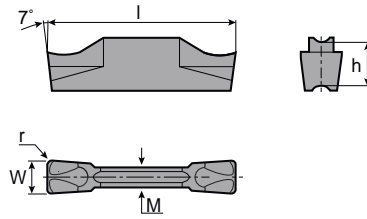

DESCRIPTION
형번

DIMENSIONS
형번

CARBIDE 재종

	DESCRIPTION 형번	DIMENSIONS 형번						CARBIDE 재종				
		W	r	l	M	h	α	TC5135	TC0525	TP0535	TP6525P	TP4505
	MGMN150-J	1.5	0.15	16.0	1.2	3.5	-	●	●	●	●	
	MGMN200-J	2.0	0.2	16.0	1.2	3.5	-	●	●	●	●	
	MGMN250-J	2.5	0.2	18.5	2.0	3.85	-	●	●	●	●	
	MGMN300-J	3.0	0.4	21.0	2.35	4.8	-	●	●	●	●	
	MGMN400-J	4.0	0.4	21.0	3.3	4.8	-	●	●	●	●	
	MGMN500-J	5.0	0.8	26.0	4.1	5.8	-	●	●	●	●	
	MGMN600-J	6.0	0.8	26.0	5.0	5.8	-	●	●	●	●	

MRMN-MTK

PROFILING / 프로파일

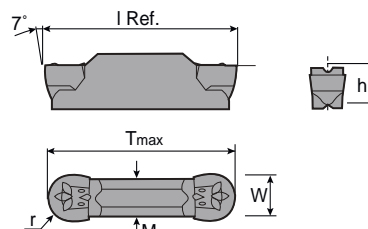

DESCRIPTION
형번

DIMENSIONS
형번

CARBIDE 재종

	DESCRIPTION 형번	DIMENSIONS 형번						CARBIDE 재종				
		W	r	l	M	h	α	TC5135	TP0525	TP0535	TP6525P	TP4505
	MRMN200-MTK	2.0	1.0	16.0	1.5	3.5	-	●	●	●	●	
	MRMN300-MTK	3.0	1.5	21.0	2.35	4.8	-	●	●	●	●	
	MRMN400-MTK	4.0	2.0	21.0	3.3	4.8	-	●	●	●	●	
	MRMN500-MTK	5.0	2.5	26.0	4.1	5.8	-	●	●	●	●	
	MRMN600-MTK	6.0	3.0	26.0	5.0	5.8	-	●	●	●	●	

Vc ● fn 203

SDGN

PARTING & GROOVING
절단 & 그루빙

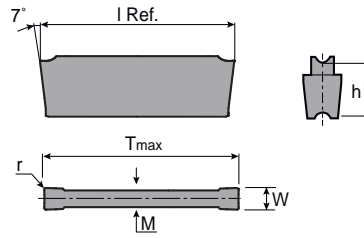

DESCRIPTION
형번

DIMENSIONS
형번

CARBIDE 재종

	TC5525P	TP0525	TP0535	TP6525P	TP4505
●	●	●	●	●	●
●	●	●	●	●	●
●	●	●	●	●	●
●	●	●	●	●	●
●	●	●	●	●	●



	W	r	l	M	h	α
SDGN2002Z	2	0.2	21	1.7	4.5	-
SDGN2202J	2.2	0.2	19.8	2.2	4.5	-
SDGN3002Z	3	0.2	21	2.4	4.5	-
SDGN3102C	3.1	0.2	20.1	2.4	4.5	-
SDGN3102Z	3.1	0.2	20.1	2.4	4.5	-

SDGR

PARTING / 절단

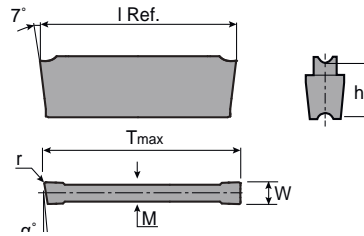

DESCRIPTION
형번

DIMENSIONS
형번

CARBIDE 재종

	TC5525P	TP0525	TP0535	TP6525P	TP4505
●	●	●	●	●	●
●	●	●	●	●	●
●	●	●	●	●	●
●	●	●	●	●	●
●	●	●	●	●	●



	W	r	l	M	h	α
SDGR2200JS-15D	2.2	0.2	19.8	1.9	4.5	15
SDGR2202J-6D	2.2	0.2	19.8	1.9	4.5	6

GROOVING 그루빙

TURNING

GROOVING

THREADING

MILLING

DRILLING

ENDMILLS

DRILLS

SPARE PARTS

INDEX

TG-C

PARTING & GROOVING
절단 & 그루빙

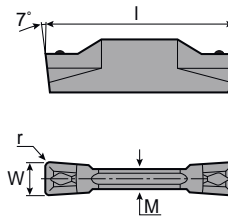

DESCRIPTION
형번

DIMENSIONS
형번

CARBIDE 재종

	DESCRIPTION 형번	DIMENSIONS 형번						CARBIDE 재종				
		W	r	l	M	h	α	TC5525P	TP0525	TP0535	TP6525P	TP4505
	TG200C-02	2.0	0.2	20.0	1.70	4.70	-	●	●	●	●	●
	TG300C-02	3.0	0.2	20.0	2.40	4.70	-	●	●	●	●	●
	TG400C-03	4.0	0.3	20.0	3.0	4.70	-	●	●	●	●	●
	TG500C-03	5.0	0.3	25.0	4.0	5.20	-	●	●	●	●	●

TG-J

PARTING & GROOVING
절단 & 그루빙

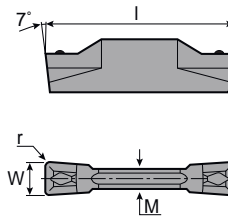

DESCRIPTION
형번

DIMENSIONS
형번

CARBIDE 재종

	DESCRIPTION 형번	DIMENSIONS 형번						CARBIDE 재종				
		W	r	l	M	h	α	TC5525P	TP0525	TP0535	TP6525P	TP4505
	TG200J-02	2.0	0.2	20.0	1.70	4.70	-	●	●	●	●	●
	TG300J-02	3.0	0.2	20.0	2.40	4.70	-	●	●	●	●	●
	TG400J-03	4.0	0.3	20.0	3.0	4.70	-	●	●	●	●	●

Vc ● fn



203

TG-J-R

PARTING 절단

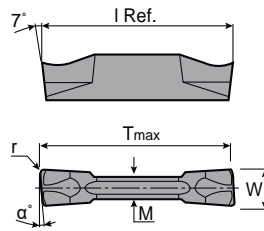

HOLDERS

206

DESCRIPTION
형번

DIMENSIONS
형번

CARBIDE 재종

	TC5525P	TP0525	TP0535	TP6525P	TP4505
TG200-J-R-15D	●	●	●	●	
TG200-J-R-6D	●	●	●	●	
TG300-J-R-6D	●	●	●	●	
TG400-J-R-6D	●	●	●	●	
TG400-J-R-4D	●	●	●	●	
TG500-J-R-4D	●	●	●	●	



TG-T

GROOVING & TURNING
그루빙 & 터닝

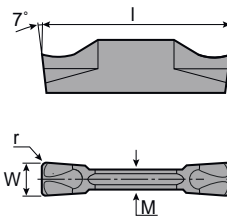

HOLDERS

206

DESCRIPTION
형번

DIMENSIONS
형번

CARBIDE 재종

	TC5525P	TP0525	TP0535	TP6525P	TP4505
TG300T-04	●	●	●	●	
TG400T-04	●	●	●	●	
TG500T-04	●	●	●	●	



Vc ● fn 203

GROOVING 그루빙

TURNING

GROOVING

THREADING

MILLING

DRILLING

ENDMILLS

DRILLS

SPARE PARTS

INDEX

TGDM

PARTING & GROOVING
절단 & 그루빙

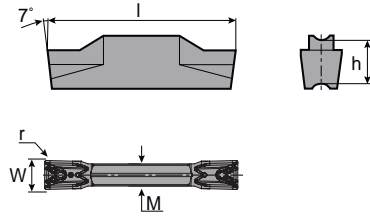

DESCRIPTION
형번

DIMENSIONS
형번

CARBIDE 재종

	DESCRIPTION 형번	DIMENSIONS 형번						CARBIDE 재종				
		W	r	l	M	h	α	TC5525P	TP0525	TP0535	TP6525P	TP4505
	TGDM200	2.00	0.2	20	1.5	4.3	-	●	●	●	●	
	TGDM300	3.00	0.3	20	2.3	4.3	-	●	●	●	●	
	TGDM400	4.00	0.3	20	3.3	4.3	-	●	●	●	●	

TGDR

PARTING 절단

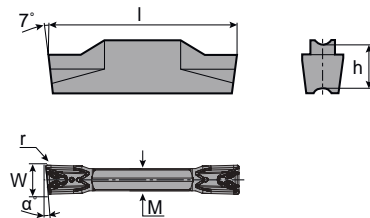

DESCRIPTION
형번

DIMENSIONS
형번

CARBIDE 재종

	DESCRIPTION 형번	DIMENSIONS 형번							CARBIDE 재종				
		W	r	l	M	h	α	TC5525P	TP0525	TP0535	TP6525	TP4505	
	TGDR200-15D	2.00	0.2	20	1.5	4.3	15	●	●	●	●		
	TGDR300-15D	3.00	0.3	20	2.3	4.3	15	●	●	●	●		

Vc ● fn 203

GRIP

PARTING & GROOVING
절단 & 그루빙

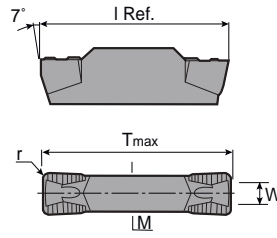

DESCRIPTION
형번

DIMENSIONS
형번

CARBIDE 재종

TC5525P	TP0525	TP0535	TP6525P	TP4505
●	●	●	●	●
●	●	●	●	●
●	●	●	●	●



GRIP300-M-TI	3.0	0.2	16.0	2.3	4.4	-
GRIP400-F-TI	4.0	0.4	19.0	2.8	4.9	-
GRIP500-M-TI	5.0	0.5	19.0	3.4	5.4	-

SP-TK

PARTING 절단

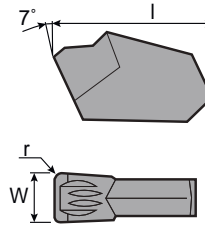

DESCRIPTION
형번

DIMENSIONS
형번

CARBIDE 재종

TC5135	TP0525	TP0535	TP6525P	TP4505
●	●			●
●	●			●
●	●			●
●	●			●
●	●			●



SP200-TK	2.2	9.3	0.2	-	-	-
SP300-TK	3.1	3.2	0.2	-	-	-
SP400-TK	4.1	11.3	0.25	-	-	-
SP500-TK	5.1	11.4	0.3	-	-	-
SP600-TK	6.4	11.4	0.35	-	-	-

GROOVING 그루빙

Cutting Parameters Vc(m/min) 절삭조건 fn(mm/rev)

FC	GREY CAST IRON 회주철
FCD	NODULAR CAST IRON 덕타일
S15C	LOW CARBON AND FREE CUTTING STEEL 저탄소강
S30C	MEDIUM CARBON STEEL 탄소강
S45C	HIGH CARBON STEEL 고탄소강
SCM	ALLOY STEEL 합금강

SUS400	마르텐사이트 & 페라이트 스테인레스 (MARTENSITIC AND FERRITIC STAINLESS STEEL)
SUS300	오스테나이트 스테인레스 (AUSTENITIC STAINLESS STEEL)
AL	알루미늄합금 (ALUMINIUM ALLOYS)
HAL	강화알루미늄합금 (AL ALLOYS AGED AND HARDENED)
NB	황동 BRASS
NC	BRONZE AND ELECTROLYTIC COPPER

MATERIAL 피삭재		CARBIDE-CVD		CARBIDE-PVD / PVD 재종		CARBIDE
		TC5525P	TP0525	TP0535	TP6525P	TU4005
K	FC	250~450	200~360	200~360		
	FCD	180~300	150~280	150~280		
P	S15C	250~350	200~320	200~320		
	S30C	220~300	180~260	180~260		
	S45C	200~280	160~250	160~250		
	SCM	180~250	150~220	150~220		
M	SUS400	160~260	160~260	160~260	160~260	
	SUS300	140~220	140~220	140~220	140~220	
N	AL					600~1500
	HAL					300~700
	NB					250~400
	NC					150~250

TURNING

GROOVING

THREADING

MILLING

DRILLING

ENDMILLS

DRILLS

SPARE PARTS

INDEX

Cutting Parameters 절삭조건 fn(mm/rev)

FC	GREY CAST IRON 회주철
FCD	NODULAR CAST IRON 덕타일
S15C	LOW CARBON AND FREE CUTTING STEEL 저탄소강
S30C	MEDIUM CARBON STEEL 탄소강
S45C	HIGH CARBON STEEL 고탄소강
SCM	ALLOY STEEL 합금강

SUS400	마르텐사이트 & 페라이트 스테인레스 (MARTENSITIC AND FERRITIC STAINLESS STEEL)
SUS300	오스테나이트 스테인레스 (AUSTENITIC STAINLESS STEEL)
AL	알루미늄합금 (ALUMINIUM ALLOYS)
HAL	강화알루미늄합금 (AL ALLOYS AGED AND HARDENED)
NB	황동 BRASS
NC	BRONZE AND ELECTROLYTIC COPPER

Parting-off 절단

MATERIAL 피삭재		CUTTING WIDTH 절삭폭(mm)				
		2 mm	3 mm	4 mm	5 mm	6 mm
K	FC	0.05~0.12	0.10~0.25	0.10~0.30	0.10~0.35	0.10~0.40
	FCD	0.05~0.10	0.10~0.20	0.10~0.25	0.10~0.30	0.10~0.35
P	S15C	0.02~0.15	0.03~0.20	0.08~0.30	0.10~0.40	0.12~0.50
	S30C	0.02~0.15	0.03~0.20	0.08~0.30	0.10~0.40	0.12~0.50
	S45C	0.02~0.15	0.03~0.20	0.08~0.30	0.10~0.40	0.12~0.50
	SCM	0.02~0.15	0.03~0.20	0.08~0.30	0.10~0.40	0.12~0.50
M	SUS400	0.02~0.10	0.03~0.15	0.08~0.25	0.10~0.35	0.12~0.40
	SUS300	0.02~0.08	0.03~0.13	0.08~0.20	0.10~0.30	0.12~0.35
N	AL	0.05~0.10	0.05~0.20	0.05~0.25	0.05~0.30	0.05~0.35
	HAL	0.05~0.10	0.05~0.20	0.05~0.25	0.05~0.30	0.05~0.35
	NB	0.05~0.10	0.05~0.20	0.05~0.25	0.05~0.30	0.05~0.35
	NC	0.05~0.10	0.05~0.20	0.05~0.25	0.05~0.30	0.05~0.35

Facing 단면그루빙

MATERIAL 피삭재		CUTTING WIDTH 절삭폭(mm)		
		3 mm	4 mm	5 mm
K	FC	0.05~0.10	0.05~0.12	0.05~0.15
	FCD	0.05~0.10	0.05~0.12	0.05~0.15
P	S15C	0.05~0.10	0.05~0.12	0.05~0.15
	S30C	0.05~0.10	0.05~0.12	0.05~0.15
	S45C	0.05~0.10	0.05~0.12	0.05~0.15
	SCM	0.05~0.10	0.05~0.12	0.05~0.15
M	SUS400	0.05~0.10	0.05~0.12	0.05~0.15
	SUS300	0.05~0.10	0.05~0.12	0.05~0.15
N	AL	0.05~0.15	0.08~0.15	0.08~0.15
	HAL	0.05~0.15	0.08~0.15	0.08~0.15
	NB	0.05~0.15	0.08~0.15	0.08~0.15
	NC	0.05~0.15	0.08~0.15	0.08~0.15

Grooving, Groove Turning 그루빙, 그루빙터닝

MATERIAL 피삭재		CUTTING WIDTH 절삭폭(mm)					
		0.5 ~ 1.0 mm	1.0 ~ 2.0 mm	2.0 ~ 3.0 mm	3.0 ~ 4.0 mm	4.0 ~ 5.0 mm	6.0 ~ 8.0 mm
K	FC	0.03~0.07	0.04~0.08	0.05~0.08	0.05~0.10	0.05~0.10	0.05~0.12
	FCD	0.03~0.07	0.04~0.08	0.05~0.08	0.05~0.10	0.05~0.10	0.05~0.12
P	S15C	0.03~0.08	0.04~0.09	0.05~0.10	0.05~0.12	0.05~0.15	0.05~0.20
	S30C	0.03~0.08	0.04~0.09	0.05~0.10	0.05~0.12	0.05~0.15	0.05~0.20
	S45C	0.03~0.07	0.04~0.08	0.05~0.08	0.05~0.10	0.05~0.12	0.05~0.15
	SCM	0.03~0.07	0.04~0.08	0.05~0.08	0.05~0.10	0.05~0.12	0.05~0.15
M	SUS400	0.03~0.08	0.04~0.09	0.05~0.10	0.05~0.12	0.05~0.12	0.05~0.15
	SUS300	0.03~0.08	0.04~0.09	0.05~0.10	0.05~0.12	0.05~0.12	0.05~0.15
N	AL	0.05~0.12	0.05~0.15	0.05~0.15	0.08~0.15	0.08~0.15	0.10~0.20
	HAL	0.05~0.12	0.05~0.15	0.05~0.15	0.08~0.15	0.08~0.15	0.10~0.20
	NB	0.05~0.12	0.05~0.15	0.05~0.15	0.08~0.15	0.08~0.15	0.10~0.20
	NC	0.05~0.12	0.05~0.15	0.05~0.15	0.08~0.15	0.08~0.15	0.10~0.20

타이거

그루빙

나사

인서트

인테그럴 드릴

엔드밀

슬리드 드릴

부품

색인표

TGER/L

screw on

TG

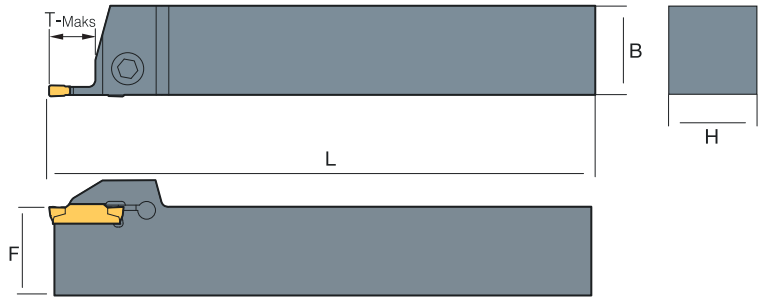

TG INSERT	DESCRIPTION 형번			STOCK 재고		DIMENSIONS 치수								
				R	L	H	B	L	F	tmax				
TG200C/J/T	TGER/L	1010	2-T12-SH	●	●	10	10	100	10.3	12	ST-SC520	ST-WRT0040		
		1212	2-T12-SH	●	●	12	12	100	12.3	12	ST-SC520	ST-WRT0040		
		1616	2-T16-SH	●	●	16	16	100	16.3	16	ST-SC520	ST-WRT0040		
TG200C/J/T	TGER/L	1212	2-T15	●	●	12	12	100	12.3	15	ST-SC520	ST-WRT0040		
		1616	2-T18	●	●	16	16	100	16.3	18	ST-SC625	ST-WRT0050		
		2020	2-T18	●	●	20	20	125	20.3	18	ST-SC625	ST-WRT0050		
		2525	2-T18	●	●	25	25	150	25.3	18	ST-SC625	ST-WRT0050		
TG300C/J/T	TGER/L	1212	3-T15	●	●	12	12	100	12.3	15	ST-SC520	ST-WRT0040		
		1616	3-T18	●	●	16	16	100	16.4	18	ST-SC625	ST-WRT0050		
		2020	3-T30	●	●	20	20	125	20.4	20	ST-SC625	ST-WRT0050		
		2525	3-T22	●	●	25	25	150	25.4	22	ST-SC625	ST-WRT0050		
TG400C/J/T	TGER/L	2020	4-T20	●	●	20	20	125	20.4	20	ST-SC625	ST-WRT0050		
		2525	4-T33	●	●	25	25	150	25.4	22	ST-SC625	ST-WRT0050		

적용인서트

▶ 199

SPPB

SP

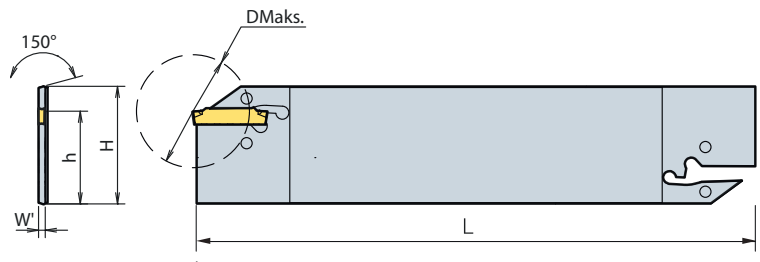

SP	-TK	DESCRIPTION 형번	STOCK 재고	DIMENSIONS 치수				WRENCH			
				H	W	L	h				
SP200-TK		SPPB-26-2	●	26	1.6	110	21	SSW50L			
		SPPB-32-2	●	32	1.6	150	25	SSW50L			
SP300-TK		SPPB-26-3	●	26	2.4	110	21	SSW50L			
		SPPB-32-3	●	32	2.4	150	25	SSW50L			
SP400-TK		SPPB-26-4	●	26	3.2	110	21	SSW50L			
		SPPB-32-4	●	32	3.2	150	25	SSW50L			

TURNING

GROOVING

THREADING

MILLING

DRILLING

ENDMILLS

DRILLS

SPARE PARTS

INDEX

carbide

202

색인표
부록
솔리드 드릴
엔드밀
인테그레이티드 드릴
밀링
나사
그루빙
터닝

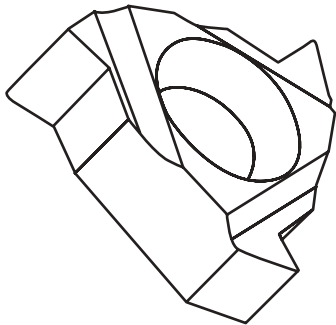
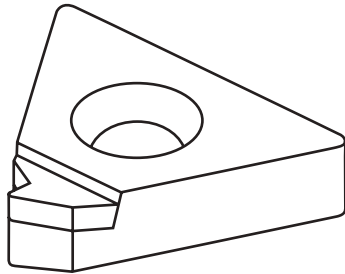
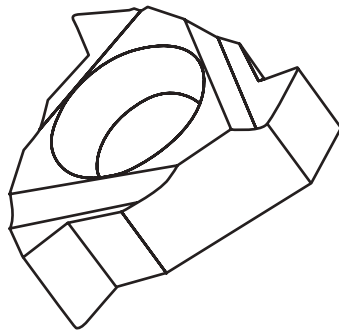

나사 THREADING/

인서트 carbide /211
홀더 / 보링바 holders /225



THREADING / carbide
나사 / 인서트

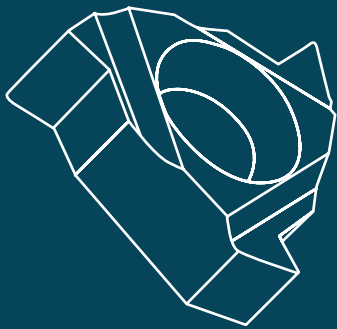
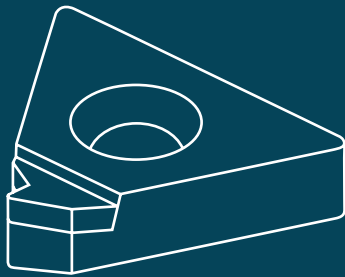

16	E	R	M
1	2	3	4

1 Insert Size (d) 인서트 사이즈

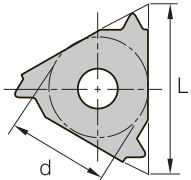
08	4.76mm	
11	6.35mm	
16	9.525mm	
22	12.70mm	
27	15.875mm	

2 Insert Type 용도

E	External
I	Internal

3 Hand of Insert 승수

R	Right
L	Left

4 Chip Breaker 칩브레이커

M		Chip Breaker Type 칩브레이커 타입
Non		Regular Type 연삭 타입

5* Pitch (Full Profile) 정피치

0.35~6.0	mm
3~72	TPI

* Should use only one table based on profile type

5* Pitch (Partial Profile) 프리피치

A	0.50~1.50
AG	0.50~3.00
G	1.75~3.00
N	3.50~5.00
Q	5.50~6.00

* Should use only one table based on profile type

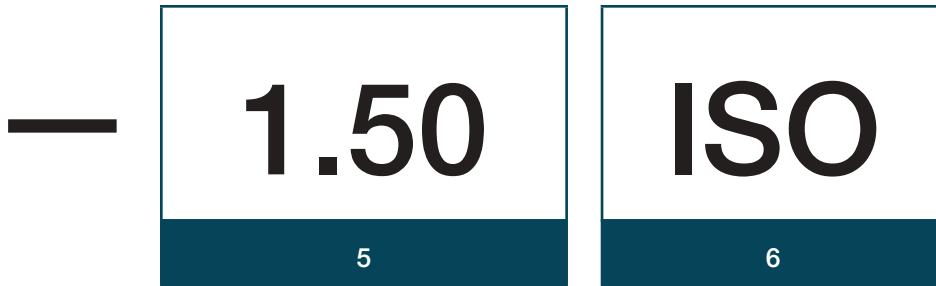

6 Thread Standard 나사 구분

60	Partial Profile 60°
55	Partial Profile 55°
STACME	Stub ACME
UN	American UN
W	Whitworth for BSW, BSP
BSPT	British Standard Pipe Thread
ABUT	American Buttress
BBUT	British Buttress

SAGE	Metric Buttress DIN513
BUT	API Buttress Casing
APIRD	API Round Casing & Tubing
EL	Extreme Line Casing
NPT	NPT
NPTF	NPTF
NPS	NPS
PG	Pg DIN 40430

API	API
ISO	ISO Metric
UNJ	UNJ
MJ	ISO 5855
TR	Trapez DIN103
ACME	ACME
RD	Round DIN405

TURNING

GROOVING

THREADING

MILLING

DRILLING

ENDMILLS

DRILLS

SPARE PARTS

INDEX

GRADES 재종

	ISO DIN 513																			
	P					M					K					N				
	P01	P10	P20	P30	P40	M01	M10	M20	M30	M40	K01	K10	K20	K30	K40	N01	N10	N20	N30	N40
CARBIDE CVD																				
CARBIDE PVD																				
CARBIDE UNCOATED																				
CERMET UNCOATED																				

TP5025

TP0025

TP5025

TP0025

THREADING 나사

Range / 재종 테이블 ISO **P** **M** **K**

Grades 재종

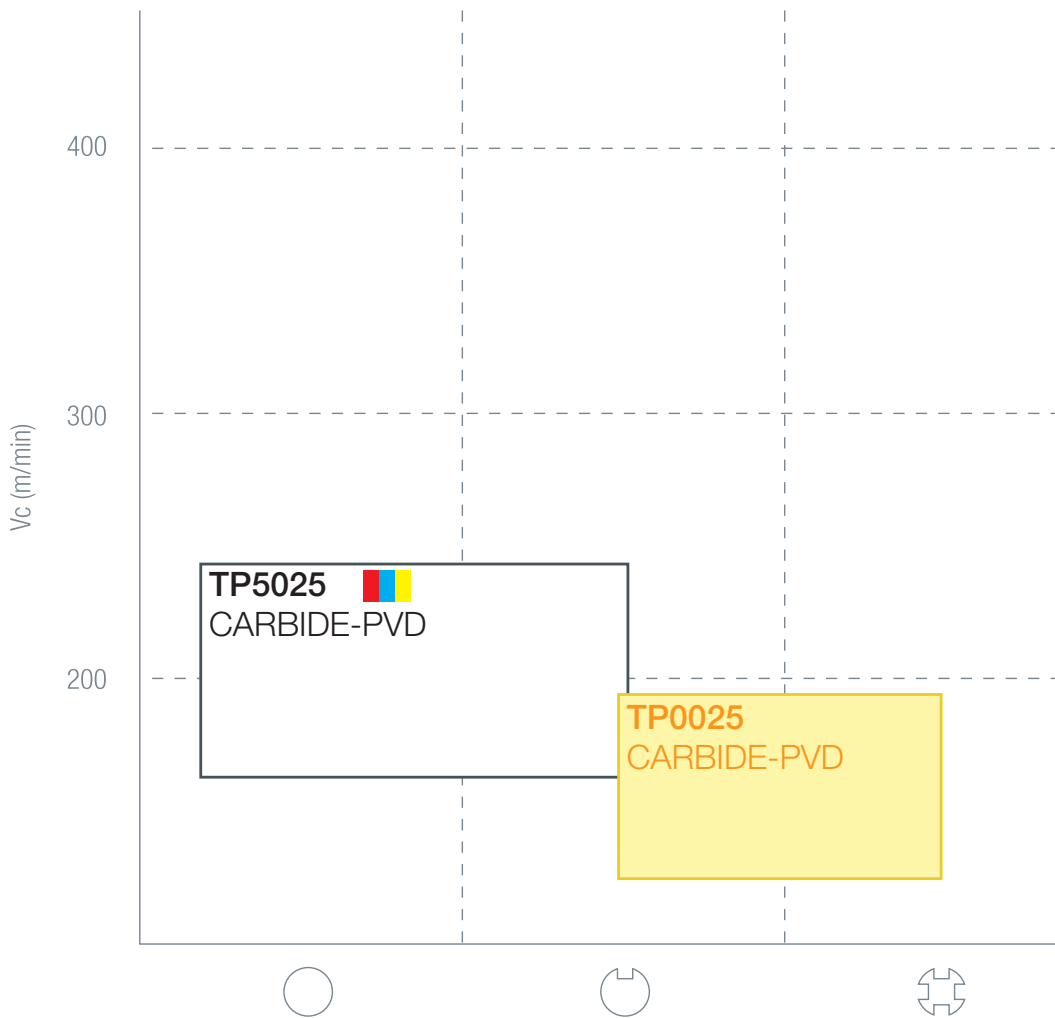

TURNING

GROOVING

THREADING

MILLING

DRILLING

ENDMILLS

DRILLS

SPARE PARTS

INDEX

ER

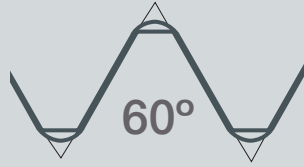

EXTERNAL PARTIAL PROFILE

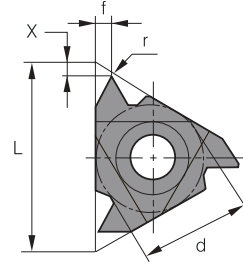

DESCRIPTION
형번

DIMENSIONS
치수

CARBIDE 재종

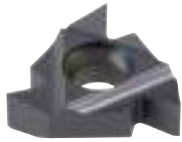

DESCRIPTION 형번			d	l	hmin	x	f	TP0025	TP5025	
	11ER-A60	0.5~1.5	48-16	6.35	11	0.05	0.8	0.9	●	●
16ER-A60	0.5~1.5	48-16	9.525	16	0.05	0.8	0.9	●	●	
16ER-G60	1.75~3.0	14-8	9.525	16	0.27	1.2	1.7	●	●	
16ER-AG60	0.5~3.0	48-8	9.525	16	0.08	1.2	1.7	●	●	
22ER-N60	3.5~5.0	7-5	12.7	22	0.53	1.7	2.5	●	●	

IR

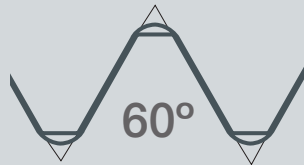

INTERNAL PARTIAL PROFILE

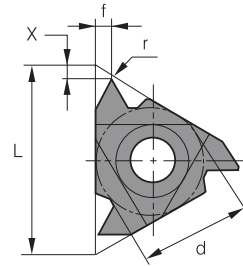

DESCRIPTION
형번

DIMENSIONS
치수

CARBIDE 재종



DESCRIPTION 형번			d	l	hmin	x	f	TP0025	TP5025	
	11IR-A60	0.5~1.5	48-16	6.35	11	0.05	0.8	0.9	●	●
16IR-A60	0.5~1.5	48-16	9.525	16	0.05	0.8	0.9	●	●	
16IR-G60	1.75~3.0	14-8	9.525	16	0.27	1.2	1.7	●	●	
16IR-AG60	0.5~3.0	48-8	9.525	16	0.08	1.2	1.7	●	●	
22IR-N60	3.5~5.0	7-5	12.7	22	0.53	1.7	2.5	●	●	

THREADING 나사

TURNING

GROOVING

THREADING

MILLING

DRILLING

ENDMILLS

DRILLS

SPARE PARTS

INDEX

ER

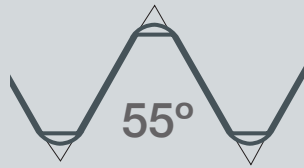

EXTERNAL PARTIAL PROFILE

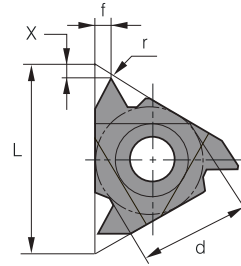

DESCRIPTION 형번	DIMENSIONS 치수								CARBIDE 재종		
		d	l	hmin	x	f	TP0025	TP5025			
	11ER-A55	0.5~1.5	48-16	6.35	11	0.05	0.8	0.9	●	●	
	16ER-A55	0.5~1.5	48-16	9.525	16	0.05	0.8	0.9	●	●	
	16ER-G55	1.75~3.0	14-8	9.525	16	0.27	1.2	1.7	●	●	
	16ER-AG55	0.5~3.0	48-8	9.525	16	0.08	1.2	1.7	●	●	
	22ER-N55	3.5~5.0	7-5	12.7	22	0.53	1.7	2.5	●	●	

IR

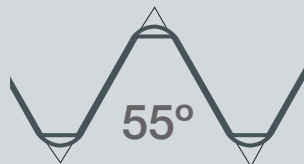

INTERNAL PARTIAL PROFILE

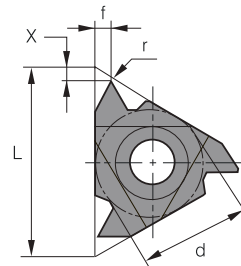

DESCRIPTION 형번	DIMENSIONS 치수								CARBIDE 재종		
		d	l	hmin	x	f	TP0025	TP5025			
	11IR-A55	0.5~1.5	48-16	6.35	11	0.05	0.8	0.9	●	●	
	16IR-A55	0.5~1.5	48-16	9.525	16	0.05	0.8	0.9	●	●	
	16IR-G55	1.75~3.0	14-8	9.525	16	0.27	1.2	1.7	●	●	
	16IR-AG55	0.5~3.0	48-8	9.525	16	0.08	1.2	1.7	●	●	
	22IR-N55	3.5~5.0	7-5	12.7	22	0.53	1.7	2.5	●	●	

ER

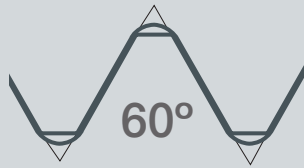

EXTERNAL METRIC

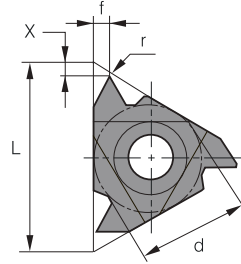

DESCRIPTION 형번		DIMENSIONS 치수							CARBIDE 재종		
			d	l	hmin	x	f	TP0025	TP5025		
	11ER-1.00ISO	1.00	6.35	11	0.61	0.7	0.7	●	●		
	11ER-1.25ISO	1.25	6.35	11	0.61	0.7	0.7	●	●		
	11ER-1.50ISO	1.50	6.35	11	0.92	0.8	1.0	●	●		
	16ER-0.50ISO	0.50	9.525	16	0.46	0.6	0.6	●	●		
	16ER-0.75ISO	0.75	9.525	16	0.46	0.6	0.6	●	●		
	16ER-1.00ISO	1.00	9.525	16	0.61	0.7	0.7	●	●		
	16ER-1.25ISO	1.25	9.525	16	0.77	0.8	0.9	●	●		
	16ER-1.50ISO	1.50	9.525	16	0.92	0.8	1.0	●	●		
	16ER-1.75ISO	1.75	9.525	16	1.07	0.9	1.2	●	●		
	16ER-2.00ISO	2.00	9.525	16	1.23	1.0	1.3	●	●		
	16ER-2.25ISO	2.25	9.525	16	1.53	1.1	1.5	●	●		
	16ER-2.50ISO	2.50	9.525	16	1.53	1.1	1.5	●	●		
	16ER-3.00ISO	3.00	9.525	16	1.84	1.2	1.6	●	●		
	22ER-3.50ISO	3.50	12.7	22	2.15	1.6	2.3	●	●		
	22ER-4.00ISO	4.00	12.7	22	2.45	1.6	2.3	●	●		
	22ER-4.50ISO	4.50	12.7	22	2.78	1.7	2.4	●	●		
22ER-5.00ISO	5.00	12.7	22	3.07	1.7	2.5	●	●			

THREADING 나사

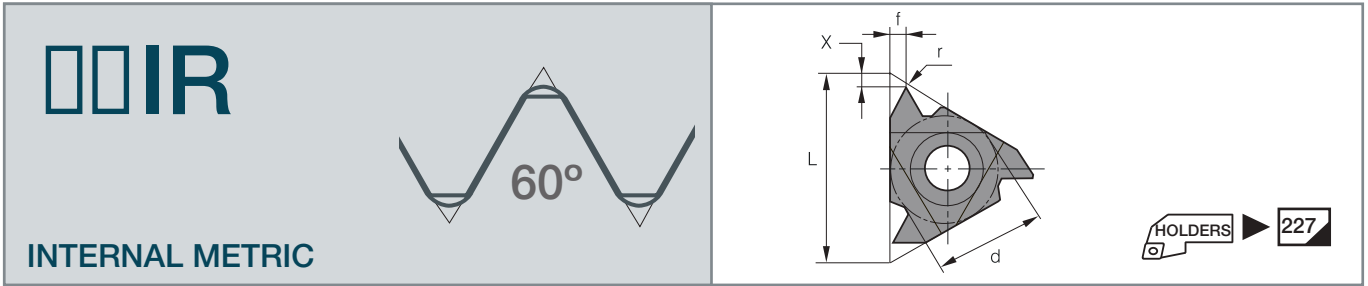

DESCRIPTION 형번		DIMENSIONS 치수							CARBIDE 재종		
		치수	d	l	hmin	x	f	TP0025	TP5025		
	11IR-1.00ISO	1.00	6.35	11	0.61	0.7	0.7	●	●		
	11IR-1.25ISO	1.25	6.35	11	0.61	0.7	0.7	●	●		
	11IR-1.50ISO	1.50	6.35	11	0.92	0.8	1.0	●	●		
	16IR-0.50ISO	0.50	9.525	16	0.46	0.6	0.6	●	●		
	16IR-0.75ISO	0.75	9.525	16	0.46	0.6	0.6	●	●		
	16IR-1.00ISO	1.00	9.525	16	0.61	0.7	0.7	●	●		
	16IR-1.25ISO	1.25	9.525	16	0.77	0.8	0.9	●	●		
	16IR-1.50ISO	1.50	9.525	16	0.92	0.8	1.0	●	●		
	16IR-1.75ISO	1.75	9.525	16	1.07	0.9	1.2	●	●		
	16IR-2.00ISO	2.00	9.525	16	1.23	1.0	1.3	●	●		
	16ER-2.25ISO	2.25	9.525	16	1.53	1.1	1.5	●	●		
	16IR-2.50ISO	2.50	9.525	16	1.53	1.1	1.5	●	●		
	16IR-3.00ISO	3.00	9.525	16	1.84	1.2	1.6	●	●		
	22IR-3.50ISO	3.50	12.7	22	2.15	1.6	2.3	●	●		
	22IR-4.00ISO	4.00	12.7	22	2.45	1.6	2.3	●	●		
	22IR-4.50ISO	4.50	12.7	22	2.78	1.7	2.4	●	●		
22IR-5.00ISO	5.00	12.7	22	3.07	1.7	2.5	●	●			

- TURNING
- GROOVING
- THREADING
- MILLING
- DRILLING
- ENDMILLS
- DRILLS
- SPARE PARTS
- INDEX

ER

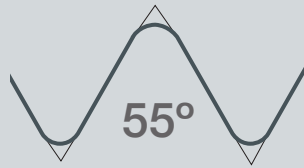

EXTERNAL WHITWORTH

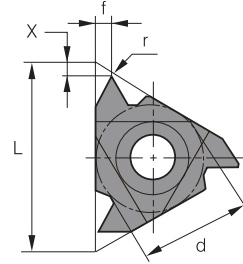

DESCRIPTION
형번

DIMENSIONS
치수

CARBIDE 재종

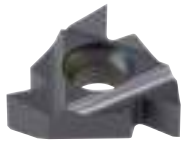

16ER-11W
16ER-14W
16ER-19W

	d	l	hmin	x	f
11	9,52	16	1,48	1,1	1,5
14	9,52	16	1,16	1	1,2
19	9,52	16	0,86	0,8	1

TP0025

TP5025

IR

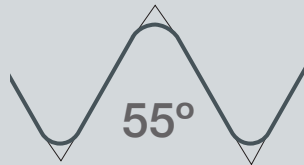

INTERNAL WHITWORTH

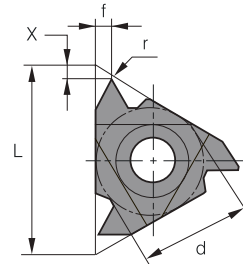

DESCRIPTION
형번

DIMENSIONS
치수

CARBIDE 재종



16IR-11W
16IR-14W
16IR-16W

	d	l	hmin	x	f
11	9,52	16	1,48	1,1	1,5
14	9,52	16	1,16	1	1,2
16	9,52	16	0,86	0,8	1

TP0025

TP5025

THREADING 나사

TURNING

GROOVING

THREADING

MILLING

DRILLING

ENDMILLS

DRILLS

SPARE PARTS

INDEX

ER

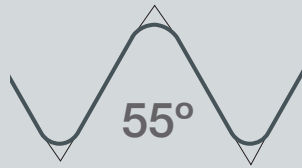

EXTERNAL BSPT

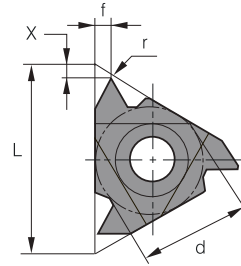

DESCRIPTION
형번

DIMENSIONS
치수

CARBIDE 재종

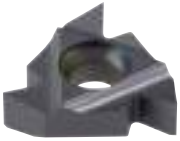
DESCRIPTION 형번	치수	CARBIDE 재종								
		TP0025	TP5025							
	치수									
	16ER-11BSPT	11	9,52	16	1,48	1,1	1,5	●	●	
	16ER-14BSPT	14	9,52	16	1,16	1	1,2	●	●	
	16ER-19BSPT	19	9,52	16	0,86	0,8	0,9	●	●	

IR

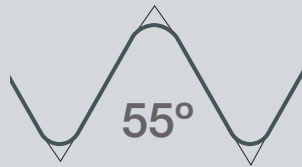

INTERNAL BSPT

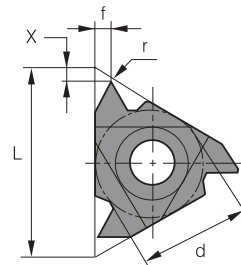

DESCRIPTION
형번

DIMENSIONS
치수

CARBIDE 재종

DESCRIPTION 형번	치수	CARBIDE 재종								
		TP0025	TP5025							
	치수									
	16IR-11BSPT	11	9,52	16	1,48	1,1	1,5	●	●	
	16IR-14BSPT	14	9,52	16	1,16	1	1,2	●	●	

□□ER

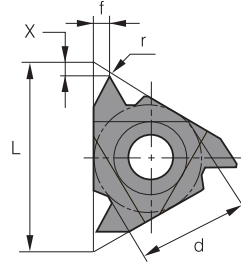
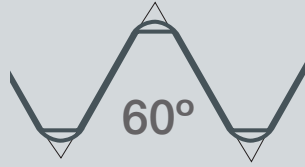

EXTERNAL UN

DESCRIPTION
형번

DIMENSIONS
치수

CARBIDE 재종



TP0025

TP5025

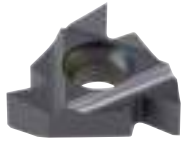

16ER-12UN

16ER-14UN

16ER-18UN

16ER-20UN

16ER-24UN

12

14

18

20

24

9,52

9,52

9,52

9,52

9,52

16

16

16

16

16

1,1

1,0

0,87

0,78

0,65

1,4

1,2

0,8

0,8

0,7

9,52

9,52

1

0,9

0,8

●

●

●

●

●

●

●

●

●

●

THREADING 나사

TURNING

GROOVING

THREADING

MILLING

DRILLING

ENDMILLS

DRILLS

SPARE PARTS

INDEX

ER

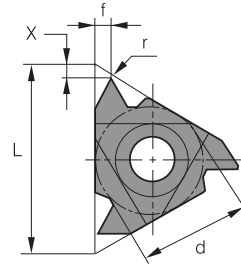
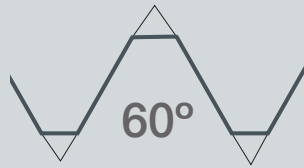

EXTERNAL NPT

DESCRIPTION 형번	DIMENSIONS 치수							CARBIDE 재종		
		d	l	hmin	x	f	TP0025	TP5025		
	11ER-14NPT	14	6,35	11	1,33	0,8	●	●		
	16ER-14NPT	16	9,52	16	1,01	0,8	●	●		
	16ER-18NPT	18	9,52	16	1,01	0,8	●	●		
	16ER-27NPT	27	9,52	16	0,66	0,7	0,8	●	●	

IR

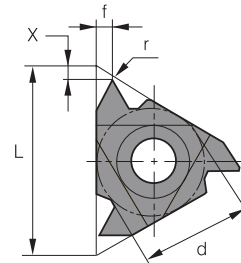
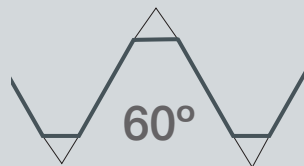

INTERNAL NPT

DESCRIPTION 형번	DIMENSIONS 치수							CARBIDE 재종		
		d	l	hmin	x	f	TP0025	TP5025		
	11IR-14NPT	14	6,35	11	1,33	0,8	●	●		
	16IR-11,5NPT	16	9,52	16	1,01	0,8	●	●		
	16IR-14NPT	14	9,52	16	1,33	0,9	1,2	●	●	

- 터닝
- 그루빙
- 나사
- 밀링
- 인테셔널 드릴
- 엔드밀
- 솔리드 드릴
- 부품
- 색인표

MTER /L

screw on

□□ER

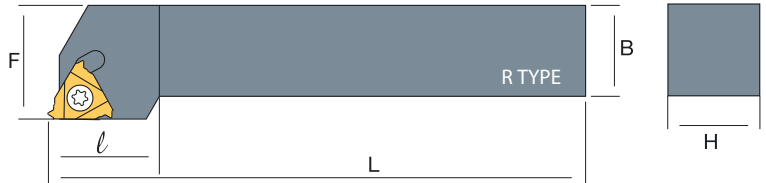

DESCRIPTION 형번	STOCK 재고		DIMENSIONS 치수						R					
	R	L	H	B	L	F	L	R						
11ER-	MTER/L	0808	E11	●	●	08	08	70	11	-	-	-	ST-SC0257	ST-WRT07
		1010	E11	●	●	10	10	70	11	-	-	-	ST-SC0257	ST-WRT07
		1212	F11	●	●	12	12	80	12	-	-	-	ST-SC0257	ST-WRT07
		1616	H11	●	●	16	16	100	16	-	-	-	ST-SC0257	ST-WRT07
16ER-	MTER/L	1616	H16	●	●	16	16	100	16	ST-SHE16	ST-SC5011	ST-WR0030	ST-SC3514	ST-WRT15
		2020	K16	●	●	20	20	125	20	ST-SHE16	ST-SC5011	ST-WR0030	ST-SC3514	ST-WRT15
		2525	M16	●	●	25	25	150	25	ST-SHE16	ST-SC5011	ST-WR0030	ST-SC3514	ST-WRT15
		3232	P16	●	●	32	32	170	32	ST-SHE16	ST-SC5011	ST-WR0030	ST-SC3514	ST-WRT15
22ER-	MTER/L	2525	M22	●	●	25	25	150	25	ST-SHE22	ST-SC6011	ST-WR0040	ST-SC0416	ST-WRT15
		3232	P22	●	●	32	32	170	32	ST-SHE22	ST-SC6011	ST-WR0040	ST-SC0416	ST-WRT15
		4040	S22	●	●	40	40	250	40	ST-SHE22	ST-SC6011	ST-WR0040	ST-SC0416	ST-WRT15

MTIR/L

screw on

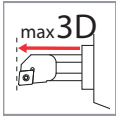
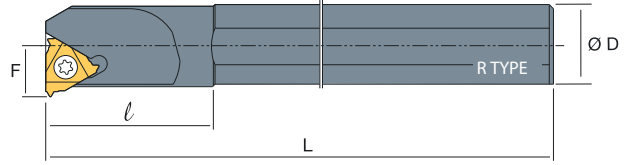
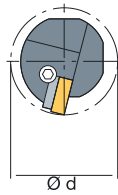

Image	DESCRIPTION 형번				STOCK 재고		DIMENSIONS 치수				R			L	
	R	L	D	d	L	F	Image	Image	Image	Image	Image	Image			
08IR-	MTIR/L	S16M	08	●	●	16	7.8	150	5.3	-	-	-	ST-SC0226	ST-WRT07	
11IR-	MTIR/L	S10K	11	●	●	10	12	125	7.4	-	-	-	ST-SC0257	ST-WRT08	
		S12K	11	●	●	12	16	125	8.4	-	-	-	ST-SC0257	ST-WRT08	
		S16M	11	●	●	16	12	150	7.4	-	-	-	ST-SC0257	ST-WRT08	
16ER-	MTIR/L	S16M	16	●	●	16	16	150	10.2	-	-	-	ST-SC3511	ST-WRT15	
		S16P	16	●	●	16	19	150	11.7	-	-	-	ST-SC3511	ST-WRT15	
		S20P	16	●	●	20	24	170	13.7	-	-	-	ST-SC3511	ST-WRT15	
		S25R	16	●	●	25	29	200	16.2	ST-SHEI16	ST-SC5011	ST-WR0030	ST-SC3514	ST-WRT15	
		S32S	16	●	●	32	36	250	19.7	ST-SHEI16	ST-SC5011	ST-WR0030	ST-SC3514	ST-WRT15	
		S40T	16	●	●	40	44	300	23.7	ST-SHEI16	ST-SC5011	ST-WR0030	ST-SC3514	ST-WRT15	
22ER-	MTIR/L	S20P	22	●	●	20	24	170	14	ST-SHEI22	ST-SC6011	ST-WR0040	ST-SC0411	ST-WRT15	
		S25R	22	●	●	25	29	200	18.1	ST-SHEI22	ST-SC6011	ST-WR0040	ST-SC0411	ST-WRT15	
		S32S	22	●	●	32	38	250	21.6	ST-SHEI22	ST-SC6011	ST-WR0040	ST-SC0411	ST-WRT15	
		S40T	22	●	●	40	46	300	25.6	ST-SHEI22	ST-SC6011	ST-WR0040	ST-SC0411	ST-WRT15	

TURNING

GROOVING

THREADING

MILLING

DRILLING

ENDMILLS

DRILLS

SPARE PARTS

INDEX

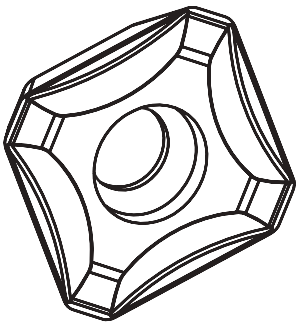
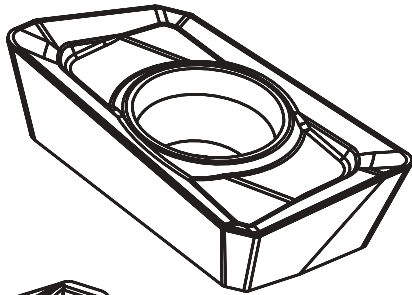
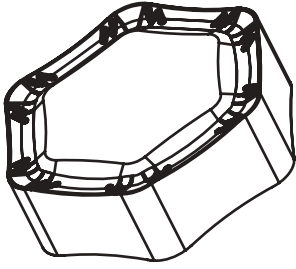

MILLING/밀링

carbide 인서트/231

holders 홀더/251

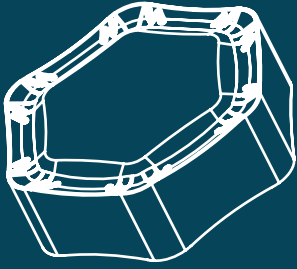



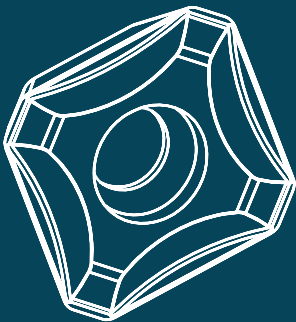
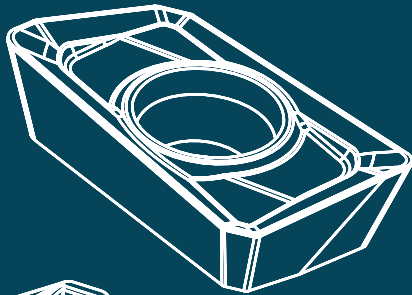

MILLING / carbide
밀링 / 인서트



Grades 재종

ISO DIN 513	K					P					M					N				
	K01	K10	K20	K30	K40	P01	P10	P20	P30	P40	M01	M10	M20	M30	M40	N01	N10	N20	N30	N40
CARBIDE CVD	TC6540P					TC6540P					TC6540P									
CARBIDE PVD	TP4505					TP5025 TP0525 TP6515P TP5020P TP0535					TP0015P TP0115P TP0025 TP0030P									
CARBIDE UNCOATED																TU4005				
CERMET UNCOATED	TT5115 TTP5115					TT5115 TTP5115					TT5115 TTP5115									





PVD CVD Milling Grades / 밀링 코팅 재종







MATERIAL	GRADE	ISO	Color	Operation
	재종	범위	색깔	적용
M	TC6540P	M05-M15 P15-P25 K15-K25	YELLOW	<ul style="list-style-type: none"> ● CVD코팅(Coated) - MT-TiCN + α-Al₂O₃ + TiN + post blasting treatment ● 강, 주철, 스테인레스의 중, 고속 가공용 (Medium to high speed machining for all material)
				
	TP0015P	M10-M20	COPPER	<ul style="list-style-type: none"> ● PVD코팅(Coated) - TiAlSiN, Premium grade ● 뛰어난 내충격성의 미립모재 사용으로 스테인레스강의 범용 선삭가공에 탁월한 효과 (As adapting micro grained substrate which has great impact resistance, Excellent in the universal machining of stainless steel) ● 내열 및 내산화성이 뛰어난 Salina 코팅 적용으로 금형 고속 밀링 가공에 추천 (As adapting Salina coating which has excellent resistance for thermal & oxidation, Recommend high speed milling in mould)
				
	TP0115P	M10-M20	BLACK	<ul style="list-style-type: none"> ● PVD코팅(Coated) - AlTiN, Premium grade ● 뛰어난 내충격성의 미립모재 사용으로 스테인레스강의 범용 선삭가공에 탁월한 효과 (As adapting micro grained substrate which has great impact resistance, Excellent in the universal machining of stainless steel) ● 뛰어난 발저스 코팅 밀착력으로 금형 고속 밀링 가공에 추천 (As adapting Balzers coating which has excellent adhesion, Recommend high speed milling in mould)
				
TP0025	M20-M30	YELLOW	<ul style="list-style-type: none"> ● PVD코팅(Coated) - TiN + TiAlN ● 스테인레스강, 난삭재와 합금강, 주철 등의 모든 피삭재에 연속 & 단속의 밀링 가공 모두 사용가능 (Superior universal turning & milling grade to cover all kinds of work piece like stainless steel and alloy steel, casting iron both continuous & interrupted cutting condition) 	
				
TP0030P	M25-M40	COPPER	<ul style="list-style-type: none"> ● PVD코팅(Coated) - TiAlSiN, Premium grade ● 스테인레스강, 난삭재와 합금강, 주철 등의 모든 피삭재에 연속 & 단속의 터닝, 밀링 가공 모두 사용가능 (Superior universal turning & milling grade to cover all kinds of work piece like stainless steel, HRSA and alloy steel, casting iron both continuous & interrupted cutting condition) 	
				
P	TP5025	P15-P35	BLACK	<ul style="list-style-type: none"> ● PVD코팅(Coated) - Advanced TiAlN ● 고경도 내산화성을 지닌 향상된 PVD박막 적용으로 모든 밀링 공정에서 강력하고 파워풀한 성능 보장 (Powerful milling grade due to the coating with high hardness and oxidation resistance at all kinds of milling)
				
	TP0525	P15-P35	BLACK	<ul style="list-style-type: none"> ● PVD코팅(Coated) - Advanced AlTiN ● 내마모성과 인성이 우수한 전용 모재와 고경도 내산화성, 내치핑성 코팅 적용으로 그루빙, 드릴링에 최적화 (Optimization for grooving and drilling due to combining the substrate of superior wear resistance and toughness with the coating of excellent oxidation/chipping resistance)
				
TP0535	P15-P35	BLACK	<ul style="list-style-type: none"> ● PVD코팅(Coated) - Advanced AlTiN ● 내마모성과 인성이 우수한 전용 모재와 고경도 내산화성, 내치핑성 코팅 적용으로 단속이 있는 그루빙, 드릴링에 최적화 (Optimization for the interrupted grooving and drilling due to combining the substrate of superior wear resistance and toughness with the coating of excellent oxidation/chipping resistance) 	
				



Uncoated Carbide Grade / 초경 재종







MATERIAL	GRADE	ISO	Color	Operation
N	TU4005	N05-N35	Silver	<ul style="list-style-type: none"> ● 초미립 모재 사용으로 내마모성 및 내치핑성 향상 (Increased wear & chipping resistance as using a ultra fine substrate) ● 마이크로 블라스팅 & 버핑 표면 처리된 샤프 인선은 비철 가공시 탁월한 수명 보장 (Excellent tool life with special surface treatment & and sharp cutting edge of AU chip breaker)
				



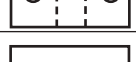

S P K N 12 03 ⁰⁸ED S R - FG

1	Geometry/ 인서트 형상
A	 90
R	 360
S	 90
T	 60

2	Clearance Angle 주절인 여유각
B	 5°
C	 7°
D	 15°
E	 20°
P	 11°
N	 0°

3	Tolerance/ 공차
	 
E	±0.025 ±0.025
G	±0.025 ±0.13
K	±0.05 ±0.15 ±0.025
M	±0.05 ±0.15 ±0.13
U	±0.08 ±0.25 ±0.13

4	Shape/ 단면형상
A	
G	
M	
N	
R	
T	
X	Special

5	Shape/ 인선길이
A	09 10 11 12 17 
R	05 06 08 10 12 
S	12 15 19 
T	16 22 

6	Thickness 인선높이(메트릭)
02	2.38
03	3.18
T3	3.97
04	4.76
06	6.35
09	9.52

7	Corner Radius 노즈(nose) "r" 크기(메트릭)
02	0.20
04	0.40
08	0.80
12	1.20
16	1.60
24	2.40

7	'E' Parallel Land 절입각	"D" Relief Angle 와이퍼 여유각
A	45°	A 3°
D	60°	B 5°
E	75°	C 7°
F	85°	D 15°
P	90°	E 20°
		F 25°
		N 0°
		P 11°

8	Edge Preparation 인선 처리
F	Sharp
E	Honing
T	Negaland
S	N/L + Honing

9	Hand / 승수
R	Right hand / 우승수
L	Left hand / 좌승수
N	Neutral

10	Series of C/B / 칩브레이커
FG	Light
FG2	Medium Rough

밀링 / MILLING

RANGE / 적용영역 ISO **K** 주철

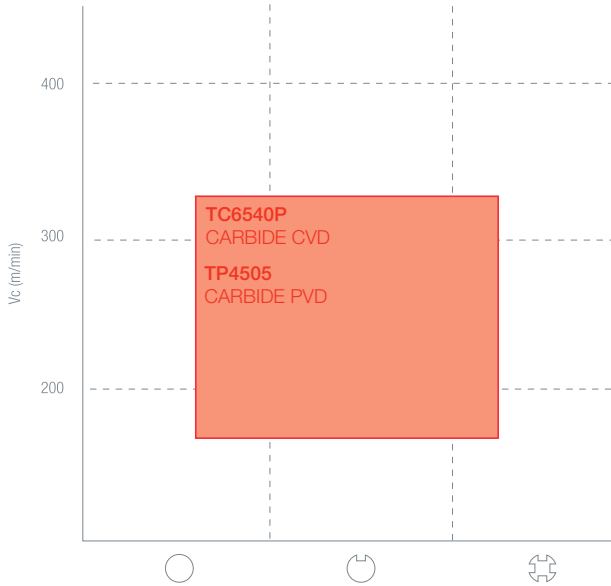

RANGE / 적용영역 ISO **M** 스테인레스

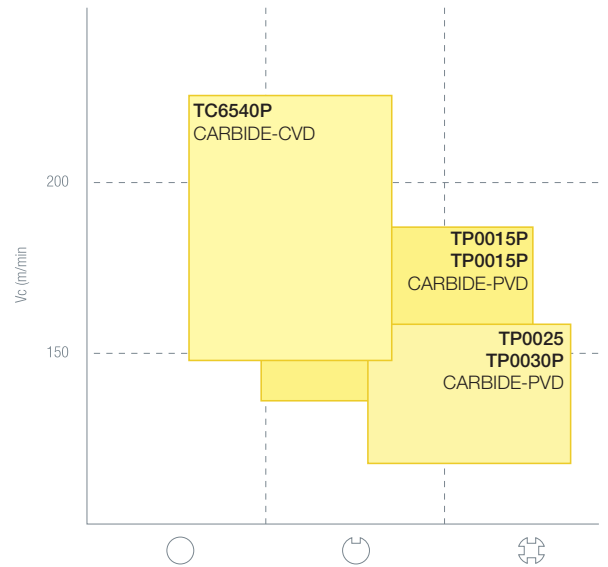

RANGE / 적용영역 ISO **P** 강용

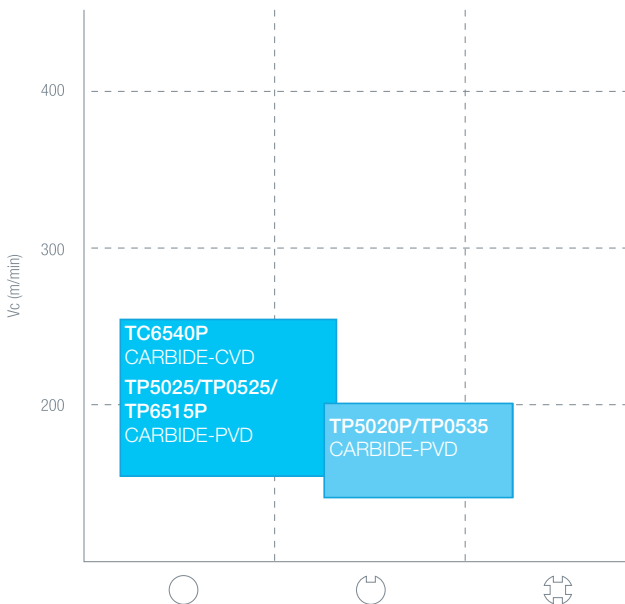

RANGE / 적용영역 ISO **N** 비철금속

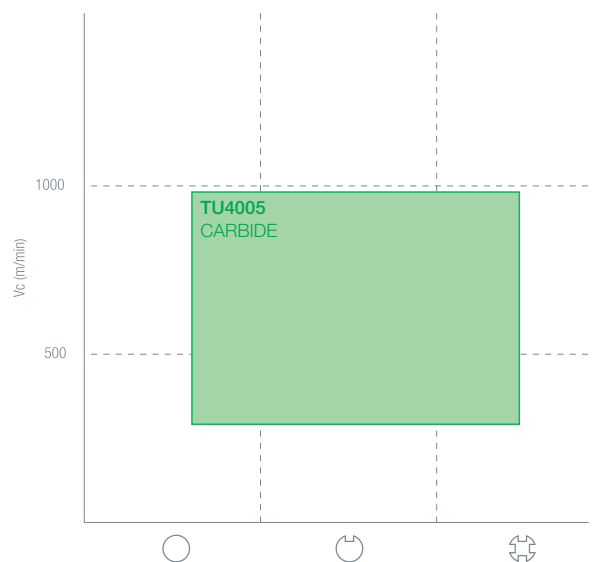

TURNING

GROOVING

THREADING

MILLING

DRILLING

ENDMILLS

DRILLS

SPARE PARTS

INDEX

터닝

그루브

나사

밀링

인테서블 드릴

엔드밀

솔리드 드릴

부품

색인표

POSITIVE 11°
with hole (포지티브11°)

AP □□

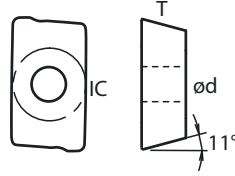

AP	09T3	1035	1135	1604	1705
IC	9,80	6,35	6,35	9,525	10,7
T	3,80	3,50	3,50	4,76	5,56
ød	2,80	2,80	2,80	4,50	4,20
Holder	-	252	-	258	-

DESCRIPTION 형번		CARBIDE-PVD PVD코팅								CVD코팅		CERMET 세멧		CARBIDE 초경	
		TP6515P	TP5020P	TP5025	TP0525	TP0535	TP4505	TP0015P	TP0115P	TP0025	TP0030P	TC6540P	TC5135	TT5115	TTP5115
	APKT09T308R-TEM	●	●								●				
	APKT1705PER-TEM	●	●								●				
	APKT170516R-TEM	●	●								●				
	APKT1705PER-AU														●
	APKT100308PDSR-30				●	●	●								
	APKT1003PDR			●											
	APKT1035PDSR						●	●		●					
	APKT113504-G2														●
	APKT113504PDFR-G2														●
	APKT1604PDER-G2														●
	APKT1604PDFR-G2														●
	APKT11T304-GM			●						●					
	APKT11T308-GM			●						●					
	APKT160408-GM			●						●					
	APKT11T308-ZM							●	●		●				
	APKT160408-ZM							●	●		●				

**POSITIVE 11°
with hole (포지티브11°)**

AP □□

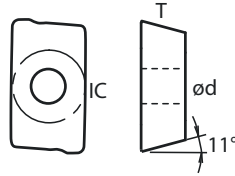

AP	09T3	1035	1135	1604	1705
IC	9,80	6,35	6,35	9,525	10,7
T	3,80	3,50	3,50	4,76	5,56
Ød	2,80	2,80	2,80	4,50	4,20
Holder	-	252	-	258	-

DESCRIPTION 형번	CARBIDE-PVD PVD코팅										CVD코팅		CERMET 세멧		CARBIDE 초경
	TP6615P	TP5020P	TP5025	TP0525	TP0535	TP4505	TP0015P	TP0115P	TP0025	TP0030P	TC6640P	TC5135	TT5115	TTP5115	TU4005
	APMT1135PDER-H2			●	●	●	●			●	●				
	APMT1604PDER-H2			●	●	●	●			●	●				
	APMT1135PDER-M2			●	●	●	●			●	●				
	APMT1604PDER-M2			●	●	●	●			●	●				
	APMT160408PDER-M2						●	●		●					

Vc ● fn ● ap 247

- TURNING
- GROOVING
- THREADING
- MILLING
- DRILLING
- ENDMILLS
- DRILLS
- SPARE PARTS
- INDEX

POSITIVE 7°
with hole 포지티브 7°

RC□□

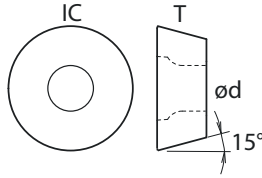

RC	0602	0803	10T3	1204	1606
IC	6,00	8,00	10,0	12,0	16,0
T	2,38	3,18	3,97	4,76	6,35
Ød	2,80	3,80	4,40	5,00	5,00

DESCRIPTION 형번	CARBIDE-PVD PVD코팅										CVD코팅	CERMET 세멧		CARBIDE 초경	
	TP6515P	TP5020P	TP5025	TP0525	TP0535	TP4505	TP0015P	TP0115P	TP0025	TP0030P	TC6540P	TC5135	TT5115	TTP5115	TU4005
	RCGT0602MO-AUP														●
	RCGT0803MO-AUP														●
	RCGT1003MO-AUP														●
	RCGT10T3MO-AUP														●
	RCGT1204MO-AUP														●
	RCKT10T3MO			●						●					
	RCKT1204MO			●			●		●						
	RCKT1606MO			●			●		●						
	RCMT0803MO				●						●				
	RCMT10T3MO			●	●				●		●				
	RCMT1204MO			●	●				●		●				
	RCMT1606MOTN			●	●				●		●				
	RCMT2006MOTN			●	●				●		●				
	RCMT2506MOTN				●						●				

POSITIVE 15°
with hole 포지티브 15°

RD□□

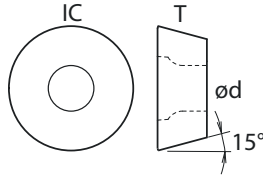

RD	050X	0802	1003	12T3	1604
IC	5,00	8,00	10,0	12,0	16,0
T	1,47	2,38	3,18	3,97	4,76
Ød	2,20	2,80	3,80	4,40	5,00
Holder	263	263	263	263	263

DESCRIPTION 형번		CARBIDE-PVD PVD코팅									CVD코팅		CERMET 세멧		CARBIDE 초경	
		TP6615P	TP5020P	TP5025	TP0525	TP0535	TP4505	TP0015P	TP0115P	TP0025	TP0030P	TC6640P	TC5135	TT5115	TTP5115	TU4005
	RDGT050XMO-AUP															●
	RDGT0702MO-AUP															●
	RDGT1003MO-AUP															●
	RDGT1204MO-AUP															●
	RDHX1003MOT				●					●						
	RDHX12T3MOT				●					●						
	RDKT10T3MOW			●						●						
	RDKT1204MO			●						●						
	RDKT1204MOA			●						●						
	RDKT1204MOT			●						●						
	RDKT1204MOW			●						●						
	RDKT1604MO			●						●						
	RDKT1604MOW			●						●						
	RDKT1605MOW			●						●						
	RDKW0802MO		●		●											
	RDKW0803MO							●			●					
	RDKW10T3MO		●					●			●					
	RDKW12T3MO		●		●	●		●			●					
	RDKW1604MO			●	●	●		●			●					
	RDMT0802MOTN		●	●	●					●						
	RDMT10T3MOTN		●	●	●					●						
	RDMT1204MOTN		●	●	●					●						
	RDMT1604MOTN			●						●						

Vc ● fn ● ap 247

POSITIVE 15°
with hole 포지티브 15°

RD □□

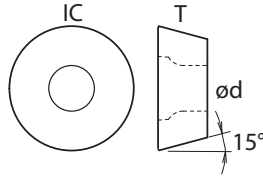

RD	0501	0802	1003	12T3	1604
IC	5,00	8,00	10,0	12,0	16,0
T	1,51	2,38	3,18	3,97	4,76
Ød	2,20	2,80	3,80	4,40	5,00

Holder ▶ 263 263 263 263 263

DESCRIPTION
형번

CARBIDE-PVD
PVD코팅

CVD코팅

CERMET
세멧

CARBIDE
초경

	TP6515P	TP5020P	TP5025	TP0525	TP0535	TP4505	TP0015P	TP0115P	TP0025	TP0030P	TC6540P	TC5135	TT5115	TTP5115	TU4005
 RDMX1003MOT			●						●						
RDMX10T3MOT							●			●					
RDMX1204MOT							●			●					
RDMX12T3MOT			●						●						
RDMX1605MOT							●			●					

밀링 / MILLING

POSITIVE 11°
with hole 포지티브 11°

RP □□

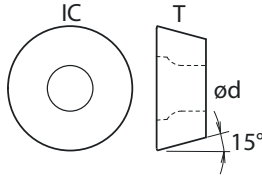

RP	0802	1003	12T3	1604	2006
IC	8,00	10,0	12,0	16,0	20,0
T	2,38	3,18	3,97	4,76	6,35
Ød	2,80	3,80	4,40	5,00	6,35
Holder					

DESCRIPTION 형번	CARBIDE-PVD PVD코팅										CVD코팅		CERMET 세멧		CARBIDE 초경		
	TP6615P	TP5020P	TP5025	TP0525	TP0535	TP4505	TP0015P	TP0115P	TP0025	TP0030P	TC6640P	TC5135	TT5115	TTP5115	TU4005		
	RPGT0803MO-AUP															●	
	RPGT1003MO-AUP															●	
	RPGT1204MO-AUP															●	
	RPKT10T3MOF						●	●									
	RPKT1204MOF						●	●		●							
	RPKT1204MO-JS						●	●		●							
	RPMT08T2MO						●	●		●							
	RPMT08T2MOE-JS		●	●	●												
	RPMT10T3MOE-JS		●	●	●			●	●								
	RPMT10T3MOE-MV	●															
	RPMT1204MO			●				●	●	●							
	RPMT1204MOE-JS		●	●	●					●							
	RPMT1204MOE-MV	●															
	RPMT1606MOE-JS			●						●							
	RPMW0802MO			●			●	●	●	●							
	RPMW08T2MO			●					●								
	RPMW0803MOT		●		●												
	RPMW1003MOT		●		●			●	●		●						
	RPMW10T3MO		●	●	●					●							
	RPMW1204MO		●	●	●	●				●							
	RPMW1204MOT		●		●	●		●	●		●						
	RPMW1606MO			●						●							
	RPMW2006MOTN			●						●							

Vc ● fn ● ap 247

TURNING
GROOVING
THREADING
MILLING
DRILLING
ENDMILLS
DRILLS
SPARE PARTS
INDEX

터닝

그루브

나사

밀링

인테셔널 드릴

엔드밀

슬리드 드릴

부품

색인표

POSITIVE 15°
포지티브 15°

SD □□

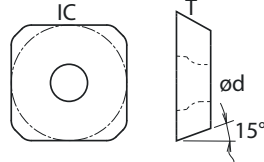





SD	09T3	1203	1204	1205	1504
IC	9,525	12,7	12,7	12,7	15,875
T	3,97	3,18	4,76	5,56	4,76
Ød	4,00	-	4,40	4,40	-

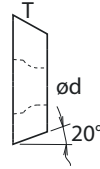
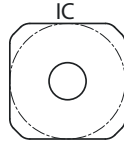

DESCRIPTION 형번	CARBIDE-PVD PVD코팅									CVD코팅	CERMET 세멧		CARBIDE 초경		
	TP6515P	TP5020P	TP5025	TP0525	TP0535	TP4505	TP0015P	TP0115P	TP0025	TP0030P	TC6540P	TC5135	TT5115	TTP5115	TU4005
SDKN1203AESN-FG			●												
SDKN1203AESN-FG2			●												
SDKN1504AESN-FG			●												
SDKN1504AESN-FG2			●												
SDMT09T312-SM			●												
SDMT120412-SM			●												
SDMT120512-GM			●												
SDMT150512-GM			●												

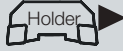
POSITIVE 20°
포지티브 20°

SE □□



SE	1203	12T3	1504
IC	12,7	13,4	15,875
T	3,18	3,97	4,76
ød	-	4,10	-
			

DESCRIPTION 형번	CARBIDE-PVD PVD코팅										CVD코팅		CERMET 세멧		CARBIDE 초경
	TP6615P	TP5020P	TP5025	TP0525	TP0535	TP4505	TP0015P	TP0115P	TP0025	TP0030P	TC6640P	TC5135	TT5115	TTP5115	TU4005
 SEET12T3-FM SEET12T3-SM			●												
			●												
 SEKN1203AFN-FG SEKN1203AFTN-FG2 SEKN1504AFTN-FG SEKN1504AFTN-FG2			●												
			●												
			●												
			●												

TURNING
GROOVING
THREADING
MILLING
DRILLING
ENDMILLS
DRILLS
SPARE PARTS
INDEX

Vc ● fn ● ap  

터닝

그루브

나사

밀링

인테셔널 드릴

엔드밀

솔리드 드릴

부품

색인표

NEGATIVE
네가티브

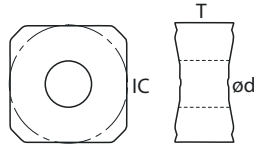

SN □□



SN	1205	1507	1907
IC	12,7	15,875	12,7
T	6,20	7,94	7,94
Ød	6,10	5,56	6,40



268

DESCRIPTION 형번	CARBIDE-PVD PVD코팅										CVD코팅	CERMET 세멧		CARBIDE 초경	
	TP6515P	TP5020P	TP5025	TP0525	TP0535	TP4505	TP0015P	TP0115P	TP0025	TP0030P	TC6540P	TC5135	TT5115	TTP5115	TU4005
 SNHQ150704			●												
SNHQ190704S			●												
 SNMX1205ANN	●		●	●		●				●					
SNMX120512-MM				●		●				●					

Vc ● fn ● ap

247

POSITIVE 11°
포지티브 11°

SP □□

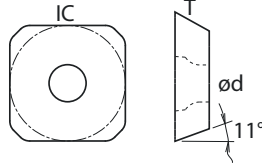

SP	0903	1203	1204	1504
IC	9,525	12,7	12,7	15,875
T	3,18	3,18	4,76	4,76
ød	4,40	-	5,50	-
Holder				

DESCRIPTION 형번	CARBIDE-PVD PVD코팅										CVD코팅	CERMET 세멧	CARBIDE 초경		
	TP6615P	TP5020P	TP5025	TP0525	TP0535	TP4505	TP0015P	TP0115P	TP0025	TP0030P	TC6640P	TC5135	TT5115	TTP5115	TU4005
	SPKN1203EDSL-FG			●											
	SPKN1203EDSL-FG2			●											
	SPKN1203EDSR-FG			●											
	SPKN1203EDSR-FG2			●											
	SPKN1504EDSL-FG			●											
	SPKN1504EDSL-FG2			●											
	SPKN1504EDSR-FG			●											
	SPKN1504EDSR-FG2			●											
	SPMT090308-M		●	●	●		●	●	●	●					
	SPMT120408-M		●	●	●		●	●	●	●					
	SPMT120412-M			●					●						
	SPMT120416-M			●					●						
	SPMT120420-M			●					●						
	SPMT120430-M			●					●						
	SPUN120304			●					●						
	SPUN120308			●					●						

TURNING

GROOVING

THREADING

MILLING

DRILLING

ENDMILLS

DRILLS

SPARE PARTS

INDEX

Vc ● fn ● ap 247

터닝

그루브

나사

밀링

인테셔널 드릴

엔드밀

솔리드 드릴

부품

색인표

POSITIVE 11°
포지티브 11°

TP □□

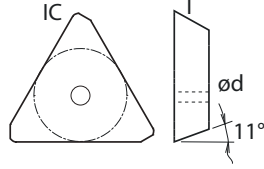

TP	1603	2204
IC	9,525	12,7
T	3,18	4,76
ød	-	-
Holder	269	269

DESCRIPTION 형번	CARBIDE-PVD PVD코팅									CVD코팅	CERMET 세멧		CARBIDE 초경		
	TP6515P	TP5020P	TP5025	TP0525	TP0535	TP4505	TP0015P	TP0115P	TP0025	TP0030P	TC6540P	TC5135	TT5115	TTP5115	TU4005
 TPKN1603PDTR-FG			●						●						
TPKN1603PDTR-FG3			●						●						
TPKN2204PDTR-FG			●						●						
TPKN2204PDTR-FG3			●						●						
TPMR160304-D3			●						●						
TPMR160308-D3			●	●					●						
			●						●						
TPUN160304			●	●					●						
TPUN160308			●	●					●						
TPUN220408			●	●					●						
TPUN220412			●						●						

Vc ● fn ● ap ▶ 247

Cutting Parameters Vc(m/min) / 절삭 조건 (속력)

FC	회주철 GRAY CAST IRON
FCD	덕타일 DUCTILE CAST IRON
S15C	저탄소강 LOW CARBON AND FREE
S30C	탄소강 MEDIUM CARBON
S45C	고탄소강 HIGH CARBON STEEL
SCM	합금강 ALLOY STEEL

SUS400	마르텐사이트 MARTENSITIC AND FERRITIC STAINLESS STEEL
SUS300	오스테나이트 AUSTENITIC STAINLESS STEEL
AL	알루미늄합금 ALUMINIUM ALLOYS
HAL	강화알루미늄합금 ALUMINIUM ALLOYS AGED AND HARDENED
NB	황동 BRASS
CU	청동, 구리 BRONZE AND ELECTROLYTIC COPPER

MATERIAL 피삭재		CARBIDE-OVD OVD 코팅	CARBIDE-PVD PVD코팅				CARBIDE 초경	
		TC6540P	TP4505	TP5025 TP0525 TP6515P	TP5020P TP0535	TP0015P TP0115P	TP0025 TP0030P	TU4005
K	FC	200~350	180~330					
	FCD	180~280	180~260					
P	S15C	180~300		180~300	160~280			
	S30C	180~300		180~300	160~280			
	S45C	160~260		160~260	140~240			
	SCM	160~260		160~260	140~240			
M	SUS400	100~180				100~170	100~150	
	SUS300	100~180				100~170	100~150	
N	AL							300~600
	HAL							200~500
	NB							200~500
	CU							200~500

TURNING

GROOVING

THREADING

MILLING

DRILLING

ENDMILLS

DRILLS

SPARE PARTS

INDEX

Cutting Parameters ap (mm) & fn (mm/rev) / 절삭 조건 (절입량 & 이송량)

AP	1035	1135	1204	1604	1705
----	------	------	------	------	------

Material 피삭재	ap (mm)	fn (mm/rev)	ap (mm)	fn (mm/rev)	ap (mm)	fn (mm/rev)	ap (mm)	fn (mm/rev)	ap (mm)	fn (mm/rev)
K	0.5-7.0	0.05-0.5	0.5-7.0	0.05-0.5	0.5-9.0	0.05-0.5	0.5-13.0	0.05-0.5	0.5-15.0	0.05-0.5
P	0.5-7.0	0.05-0.5	0.5-7.0	0.05-0.5	0.5-9.0	0.05-0.5	0.5-13.0	0.05-0.5	0.5-15.0	0.05-0.5
M	0.5-5.0	0.05-0.5	0.5-5.0	0.05-0.5	0.5-6.0	0.05-0.5	0.5-9.0	0.05-0.5	0.5-11.0	0.05-0.5
N	0.5-7.0	0.05-0.4	0.5-7.0	0.08-0.4	0.5-9.0	0.1-0.4	0.5-13.0	0.1-0.4	0.5-15.0	0.1-0.4

RC/ RP	08T2	10T3	1204	1606	2006
--------	------	------	------	------	------

Material 피삭재	ap (mm)	fn (mm/rev)	ap (mm)	fn (mm/rev)	ap (mm)	fn (mm/rev)	ap (mm)	fn (mm/rev)	ap (mm)	fn (mm/rev)
K	0.5-3.0	0.1-0.3	0.5-4.0	0.1-0.4	0.5-5.0	0.1-0.5	0.5-7.0	0.1-0.6	0.7-9.0	0.1-0.7
P	0.5-3.0	0.1-0.3	0.5-4.0	0.1-0.4	0.5-5.0	0.1-0.5	0.5-7.0	0.1-0.6	0.7-9.0	0.1-0.7
M	0.3-2.5	0.08-0.25	0.3-4.0	0.08-0.3	0.5-5.0	0.08-0.35	0.5-7.0	0.08-0.4	0.5-7.0	0.08-0.6
N										

RD	0501	0802	1003	12T3	1604
----	------	------	------	------	------

Material 피삭재	ap (mm)	fn (mm/rev)	ap (mm)	fn (mm/rev)	ap (mm)	fn (mm/rev)	ap (mm)	fn (mm/rev)	ap (mm)	fn (mm/rev)
K	0.2-2.0	0.05-0.25	0.2-3.0	0.1-0.3	0.5-4.0	0.1-0.4	0.5-5.0	0.1-0.5	0.5-7.0	0.1-0.6
P	0.2-2.0	0.05-0.25	0.2-3.0	0.1-0.3	0.5-4.0	0.1-0.4	0.5-5.0	0.1-0.5	0.5-7.0	0.1-0.6
M	0.2-2.0	0.03-0.2	0.2-3.0	0.08-0.25	0.3-4.0	0.08-0.3	0.5-5.0	0.08-0.35	0.5-7.0	0.08-0.4
N										

SNMX	1205	-	-	-	-
------	------	---	---	---	---

Material 피삭재	ap (mm)	fn (mm/rev)	ap (mm)	fn (mm/rev)	ap (mm)	fn (mm/rev)	ap (mm)	fn (mm/rev)	ap (mm)	fn (mm/rev)
K	1.0-5.0	0.1-0.35								
P	1.0-5.0	0.1-0.35								
M	1.0-5.0	0.1-0.35								
N										

Cutting Parameters ap (mm) & fn (mm/rev)

SDKN	1203	1504	-	-	-
-------------	-------------	-------------	----------	----------	----------

Material 피삭재	ap (mm)	fn (mm/rev)	ap (mm)	fn (mm/rev)	ap (mm)	fn (mm/rev)	ap (mm)	fn (mm/rev)	ap (mm)	fn (mm/rev)
K	1.0-5.0	0.05-0.3	1.0-7.0	0.05-0.3						
P	1.0-5.0	0.05-0.3	1.0-7.0	0.05-0.3						
M	1.0-5.0	0.05-0.3	1.0-7.0	0.05-0.3						
N										

TPKN	1603	2204	-	-	-
-------------	-------------	-------------	----------	----------	----------

Material 피삭재	ap (mm)	fn (mm/rev)	ap (mm)	fn (mm/rev)	ap (mm)	fn (mm/rev)	ap (mm)	fn (mm/rev)	ap (mm)	fn (mm/rev)
K	1.0-12.0	0.05-0.3	1.0-15.0	0.05-0.3						
P	1.0-12.0	0.05-0.3	1.0-15.0	0.05-0.3						
M	1.0-12.0	0.05-0.3	1.0-15.0	0.05-0.3						
N										

SPKN	1203	1504	-	-	-
-------------	-------------	-------------	----------	----------	----------

Material 피삭재	ap (mm)	fn (mm/rev)	ap (mm)	fn (mm/rev)	ap (mm)	fn (mm/rev)	ap (mm)	fn (mm/rev)	ap (mm)	fn (mm/rev)
K	1.0-8.0	0.05-0.3	1.0-10.0	0.05-0.3						
P	1.0-8.0	0.05-0.3	1.0-10.0	0.05-0.3						
M	1.0-8.0	0.05-0.3	1.0-10.0	0.05-0.3						
N										

TURNING

GROOVING

THREADING

MILLING

DRILLING

ENDMILLS

DRILLS

SPARE PARTS

INDEX

MILLING PVD Comparison table (밀링 PVD 재종 비교표)

MATERIAL 피삭재	K-CERA	ISCAR	SECO	TEAGUTEC	KYOCERA	SANDVIK	KENAMETAL	MITSUBISHI	WALTER	KORLOY
P	TP0005(H)P									PC2005
	TP0105P					P20A				PC2010
	TP0010P					GC1010		AP20M		PC2015
								MP6120	WKP25	
	TP0015P									
	TP0115P							VP15TF		
	TP5015P	IC903	MP3000	TT7070			KC522M			PC3500
	TP5020P	IC908		TT7080	PR730	GC1025	KCU20M	UP20M	WKP35	
	TP5025	IC950	F25M	TT7030		GC1030				
	TP0525									
	TP0025		F30M		PR830		KC935M			PC5300
	TP0535	IC928	F40M	TT8020	PR660	GC1030	KC7140	VP30RT	WKP35	PC5400
TP0030P										
M	TP6505P	IC903			PR730		KC5510			
	TP6515P						KC7020			
	TP0015P					GC1125	KC522M	MP7130		
	TP0525					GC1025	KC725M			
	TP6525P									
		IC900	F25M							
	TP0025	IC250	F30M	TT9030	PR1025	GC2030	KC735M		WQM35	PC5300
	TP0535	IC928	F40M	TT9080	PR660	GC1030	KC722	KC7140	WSM35S	PC5400
		IC328		TT8020					WSP45	PC3545
	TP0015P									
S	TP0525					GC1025		VP15TF		
	TP6525P	IC328	F40M	TT9030	PR620	GC1040	KC510M	VP30RT		
	TP0025	IC408	MS2050	TT9080	PR660	S40T	KCU30M	MP9130	WSM35S	PC5300
	TP0535			TT8020	PR1535				WSM45S	PC5400

MILLING / cutter

밀링 커터



MSAP

AP□□10

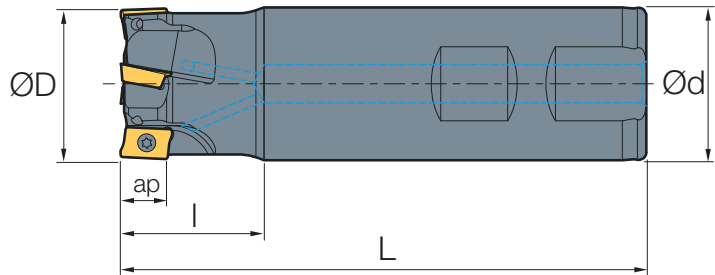

AP	DESCRIPTION 형번		STOCK 재고	DIMENSIONS 치수										
	D	L		l	d	Z	ap							
AP 10	MSAP	12-120-10-12-1T	●	12	120	30	12	1T	10	ST-SC0256	ST-WRT08			
		12-120-10-16-1T	●	12	120	30	16	1T	10	ST-SC0256	ST-WRT08			
		14-120-10-16-1T	●	14	120	30	16	1T	10	ST-SC0256	ST-WRT08			
		16-120-10-16-2T	●	16	120	30	16	2T	10	ST-SC0256	ST-WRT08			
		16-120-10-16-2T-C	●	16	120	30	16	2T	10	ST-SC0256	ST-WRT08			
		16-150-10-16-2T	●	16	150	40	16	2T	10	ST-SC0256	ST-WRT08			
		16-150-10-16-2T-C	●	16	150	40	16	2T	10	ST-SC0256	ST-WRT08			
		16-200-10-16-2T	●	16	200	50	16	2T	10	ST-SC0256	ST-WRT08			
		18-120-10-16-2T	●	18	120	30	16	2T	10	ST-SC0256	ST-WRT08			
		18-150-10-16-2T	●	18	150	40	16	2T	10	ST-SC0256	ST-WRT08			
		18-200-10-16-2T	●	18	200	50	16	2T	10	ST-SC0256	ST-WRT08			
		20-120-10-20-3T	●	20	120	30	20	3T	10	ST-SC0256	ST-WRT08			
		20-120-10-20-3T-C	●	20	120	30	20	3T	10	ST-SC0256	ST-WRT08			
		20-150-10-20-3T	●	20	150	40	20	3T	10	ST-SC0256	ST-WRT08			
		20-200-10-20-3T	●	20	200	50	20	3T	10	ST-SC0256	ST-WRT08			
		22-120-10-20-3T	●	22	120	30	20	3T	10	ST-SC0256	ST-WRT08			
		22-150-10-20-3T	●	22	150	40	20	3T	10	ST-SC0256	ST-WRT08			
		22-200-10-20-3T	●	22	200	50	20	3T	10	ST-SC0256	ST-WRT08			
		23-120-10-20-3T	●	23	120	30	20	3T	10	ST-SC0256	ST-WRT08			
		24-120-10-20-3T	●	24	120	30	20	3T	10	ST-SC0256	ST-WRT08			
	24-150-10-20-3T	●	24	150	40	20	3T	10	ST-SC0256	ST-WRT08				

적용인서트

236

MSAP

AP□□10

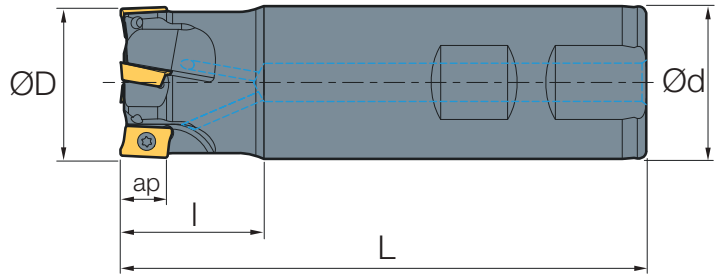

AP	DESCRIPTION 형번	STOCK 재고	DIMENSIONS 치수										
			D	L	l	d	Z	ap					
AP 10	MSAP 24-200-10-20-3T	●	24	200	50	20	3T	10	ST-SC0256	ST-WRT08			
	25-120-10-25-3T	●	25	120	30	25	3T	10	ST-SC0256	ST-WRT08			
	25-120-10-25-3T-C	●	25	120	30	25	3T	10	ST-SC0256	ST-WRT08			
	25-150-10-25-3T	●	25	150	40	25	3T	10	ST-SC0256	ST-WRT08			
	25-200-10-25-3T	●	25	200	50	25	3T	10	ST-SC0256	ST-WRT08			
	25-250-10-25-3T	●	25	250	50	25	3T	10	ST-SC0256	ST-WRT08			
	26-120-10-25-3T	●	26	120	30	25	3T	10	ST-SC0256	ST-WRT08			
	26-120-10-25-3T-C	●	26	120	30	25	3T	10	ST-SC0256	ST-WRT08			
	26-150-10-25-3T	●	26	150	40	25	3T	10	ST-SC0256	ST-WRT08			
	26-200-10-25-3T	●	26	200	50	25	3T	10	ST-SC0256	ST-WRT08			
	30-120-10-25-4T	●	30	120	30	25	4T	10	ST-SC0256	ST-WRT08			
	30-150-10-25-4T	●	30	150	40	25	4T	10	ST-SC0256	ST-WRT08			
	32-120-10-25-4T	●	32	120	30	25	4T	10	ST-SC0256	ST-WRT08			
	32-120-10-32-4T	●	32	120	30	32	4T	10	ST-SC0256	ST-WRT08			
	32-120-10-32-4T-C	●	32	120	30	32	4T	10	ST-SC0256	ST-WRT08			
	32-150-10-25-4T	●	32	150	40	25	4T	10	ST-SC0256	ST-WRT08			
	32-150-10-32-4T	●	32	150	40	32	4T	10	ST-SC0256	ST-WRT08			
	32-300-10-32-4T	●	32	300	50	32	4T	10	ST-SC0256	ST-WRT08			
	35-120-10-32-5T	●	35	120	30	32	5T	10	ST-SC0256	ST-WRT08			
	40-120-10-32-5T	●	40	120	30	32	5T	10	ST-SC0256	ST-WRT08			
40-150-10-32-5T	●	40	150	40	32	5T	10	ST-SC0256	ST-WRT08				

TURNING

GROOVING

THREADING

MILLING

DRILLING

ENDMILLS

DRILLS

SPARE PARTS

INDEX

carbide

236

MMAP

AP□□10

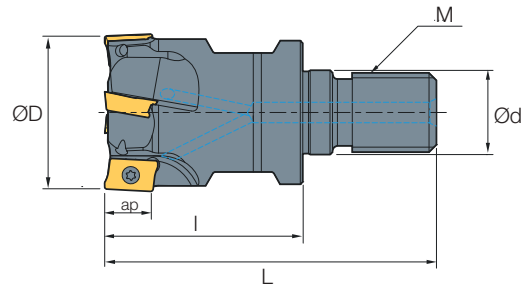

AP	DESCRIPTION 형번		STOCK 재고	DIMENSIONS 치수											
	D	L		I	d	Z	M	ap							
AP 10	MMA	16-M08-10-2T-C	●	16	50	28	8.5	2T	08	10	ST-SC0257	ST-WRT08			
		20-M10-10-3T-C	●	20	50	28	10.5	3T	10	10	ST-SC0257	ST-WRT08			
		25-M12-10-3T-C	●	25	50	28	12.5	3T	12	10	ST-SC0257	ST-WRT08			
		32-M16-10-4T-C	●	32	60	35	17	4T	16	10	ST-SC0257	ST-WRT08			
		35-M16-10-4T	●	35	60	35	17	4T	16	10	ST-SC0257	ST-WRT08			
		40-M16-10-5T-C	●	40	60	35	17	5T	16	10	ST-SC0257	ST-WRT08			
		42-M16-10-5T-C	●	42	60	35	17	5T	16	10	ST-SC0257	ST-WRT08			

MFAP

AP□□10

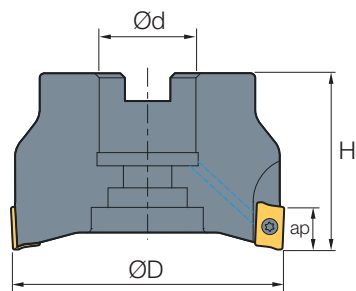

AP	DESCRIPTION 형번		STOCK 재고	DIMENSIONS 치수								
	MFAP			D	H	d	Z	ap				
AP 10	90040R-10-5T	●	40	40	16	5T	10	ST-SC0257	ST-WRT08			
	90040R-10-5T-C	●	40	40	16	5T	10	ST-SC0257	ST-WRT08			
	90050R-10-6T	●	50	40	22	6T	10	ST-SC0257	ST-WRT08			
	90050R-10-6T-C	●	50	40	22	6T	10	ST-SC0257	ST-WRT08			
	90063R-10-7T	●	63	40	22	7T	10	ST-SC0257	ST-WRT08			
	90063R-10-7T-C	●	63	40	22	7T	10	ST-SC0257	ST-WRT08			
	90080R-10-8T	●	80	50	27	8T	10	ST-SC0257	ST-WRT08			
	90080R-10-8T-C	●	80	50	27	8T	10	ST-SC0257	ST-WRT08			
	90100R-10-9T	●	100	50	32	9T	10	ST-SC0257	ST-WRT08			
	90100R-10-9T-C	●	100	50	32	9T	10	ST-SC0257	ST-WRT08			
	90125R-10-11T	●	125	50	40	11T	10	ST-SC0257	ST-WRT08			

carbide 236



- TURNING
- GROOVING
- THREADING
- MILLING**
- DRILLING
- ENDMILLS
- DRILLS
- SPARE PARTS
- INDEX

MFAP

AP□□10

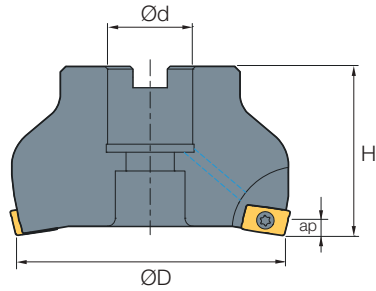



AP	DESCRIPTION 형번	STOCK 재고	DIMENSIONS 치수								
			D	H	d	Z	ap				
AP 10	MFAP 75063R-10-5T	●	63	40	22	5T	5	ST-SC0257	ST-WRT08		
	75063R-10-5T-C	●	63	40	22	5T	5	ST-SC0257	ST-WRT08		
	75080R-10-6T	●	80	40	27	6T	5	ST-SC0257	ST-WRT08		
	75080R-10-6T-C	●	80	40	27	6T	5	ST-SC0257	ST-WRT08		
	75100R-10-7T	●	100	50	32	7T	5	ST-SC0257	ST-WRT08		
	75100R-10-7T-C	●	100	50	32	7T	5	ST-SC0257	ST-WRT08		

적용인서트 ▶ 236

MSAP

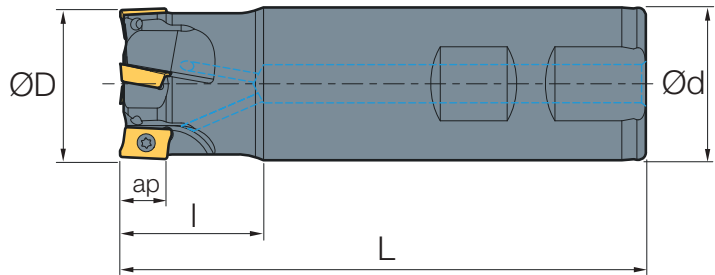
AP□□12





AP	DESCRIPTION 형번		STOCK 재고	DIMENSIONS 치수						 ← 			
	MSAP			D	L	l	d	Z	ap				
AP 12	MSAP	20-150-12-20-2T	●	20	150	30	20	2T	12	ST-SC0256	ST-WRT08		
		20-200-12-20-2T	●	20	200	40	20	2T	12	ST-SC0256	ST-WRT08		
		25-150-12-25-3T	●	25	150	30	25	3T	12	ST-SC0256	ST-WRT08		
		25-200-12-25-3T	●	25	200	40	25	3T	12	ST-SC0256	ST-WRT08		
		32-150-12-32-4T	●	32	150	30	32	4T	12	ST-SC0256	ST-WRT08		
		32-200-12-25-3T	●	32	200	40	25	3T	12	ST-SC0256	ST-WRT08		
		40-200-12-40-5T	●	40	200	40	40	5T	12	ST-SC0256	ST-WRT08		

MFAP

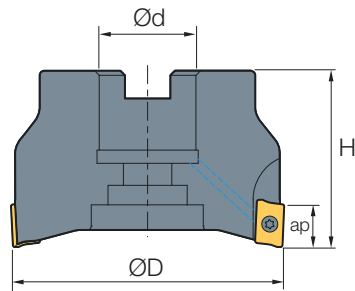
AP□□12



AP	DESCRIPTION 형번		STOCK 재고	DIMENSIONS 치수					 ← 			
	MFAP			D	H	d	Z	ap				
AP 12	MFAP	90050R-12-6T	●	50	40	22	6T	12	ST-SC0257	ST-WRT08		
		90063R-12-7T	●	63	40	22	7T	12	ST-SC0257	ST-WRT08		
		90080R-12-8T	●	80	50	27	8T	12	ST-SC0257	ST-WRT08		

carbide

236

MSAP

AP□□16

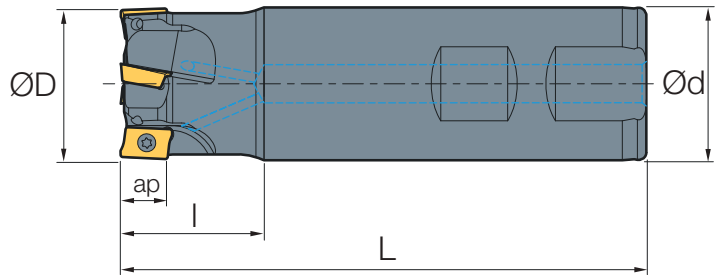

AP	DESCRIPTION 형번	STOCK 재고	DIMENSIONS 치수										
			D	L	l	d	Z	ap					
AP 16	MSAP 25-120-16-25-2T	●	25	120	30	25	2T	16	ST-SC0256	ST-WRT08			
	25-150-16-25-2T	●	25	150	40	25	2T	16	ST-SC0256	ST-WRT08			
	25-200-16-25-2T	●	25	200	50	25	2T	16	ST-SC0256	ST-WRT08			
	25-250-16-25-2T	●	25	250	70	25	2T	16	ST-SC0256	ST-WRT08			
	26-120-16-25-2T	●	26	120	30	25	2T	16	ST-SC0256	ST-WRT08			
	26-150-16-25-2T	●	26	150	40	25	2T	16	ST-SC0256	ST-WRT08			
	26-200-16-25-2T	●	26	200	50	25	2T	16	ST-SC0256	ST-WRT08			
	28-120-16-25-2T	●	28	120	30	25	2T	16	ST-SC0256	ST-WRT08			
	28-150-16-25-2T	●	28	150	40	25	2T	16	ST-SC0256	ST-WRT08			
	28-200-16-25-2T	●	28	200	50	25	2T	16	ST-SC0256	ST-WRT08			
	30-120-16-25-3T	●	30	120	30	25	2T	16	ST-SC0256	ST-WRT08			
	30-150-16-25-3T	●	30	150	40	25	3T	16	ST-SC0256	ST-WRT08			
	30-200-16-25-3T	●	30	200	50	25	3T	16	ST-SC0256	ST-WRT08			
	32-120-16-25-3T	●	32	120	30	25	3T	16	ST-SC0256	ST-WRT08			
	32-120-16-32-3T	●	32	120	30	32	3T	16	ST-SC0256	ST-WRT08			
	32-150-16-25-3T	●	32	150	50	25	3T	16	ST-SC0256	ST-WRT08			

적용인서트 ▶ 236

터너
그라운드
나사
밀링
인테그럴 드릴
엔드밀
슬리드 드릴
부품
색인표

MSAP

AP□□16

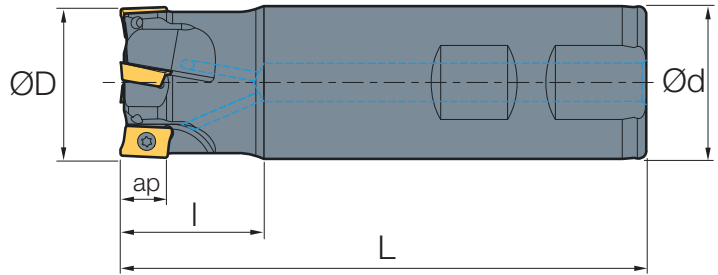

AP	DESCRIPTION 형번		STOCK 재고	DIMENSIONS 치수										
	MSAP			D	L	l	d	Z	ap					
AP 16	MSAP	32-200-16-32-3T	●	32	200	50	32	3T	16	ST-SC0256	ST-WRT08			
		32-250-16-32-3T	●	32	250	70	32	3T	16	ST-SC0256	ST-WRT08			
		32-300-16-32-3T	●	32	300	70	32	3T	16	ST-SC0256	ST-WRT08			
		34-120-16-32-3T	●	34	120	30	32	3T	16	ST-SC0256	ST-WRT08			
		34-150-16-32-3T	●	34	150	50	32	3T	16	ST-SC0256	ST-WRT08			
		34-200-16-32-3T	●	34	200	50	32	3T	16	ST-SC0256	ST-WRT08			
		35-120-16-32-3T	●	35	120	30	32	3T	16	ST-SC0256	ST-WRT08			
		35-150-16-32-3T	●	35	150	50	32	3T	16	ST-SC0256	ST-WRT08			
		35-200-16-32-3T	●	35	200	50	32	3T	16	ST-SC0256	ST-WRT08			
		36-120-16-32-3T	●	36	120	30	32	3T	16	ST-SC0256	ST-WRT08			
		38-120-16-32-4T	●	38	120	30	32	4T	16	ST-SC0256	ST-WRT08			
		40-120-16-32-4T	●	40	120	30	32	4T	16	ST-SC0256	ST-WRT08			
		40-150-16-25-4T	●	40	150	50	25	4T	16	ST-SC0256	ST-WRT08			
		40-150-16-32-4T	●	40	150	50	32	4T	16	ST-SC0256	ST-WRT08			
	40-200-16-32-4T	●	40	200	50	32	4T	16	ST-SC0256	ST-WRT08				

carbide 236

타이거

그라운드

나사

밀링

인테그럴 드릴

엔드밀

슬리드 드릴

부품

색인표

MMAP

AP□□16

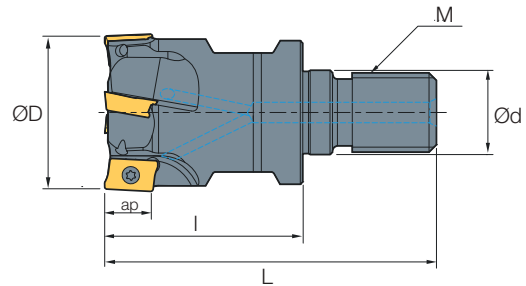

AP	DESCRIPTION 형번		STOCK 재고	DIMENSIONS 치수											
	D	L		I	d	Z	ap	M							
AP 16	MMA	25-M12-16-2T-C	●	25	60	43	12	2T	16	12	ST-SC0257	ST-WRT08			
		32-M16-16-3T-C	●	32	60	43	16	3T	16	16	ST-SC0257	ST-WRT08			
		40-M16-16-4T-C	●	40	60	43	16	4T	16	16	ST-SC0257	ST-WRT08			
		42-M16-16-4T-C	●	42	60	43	16	4T	16	16	ST-SC0257	ST-WRT08			

MFAP

AP□□16

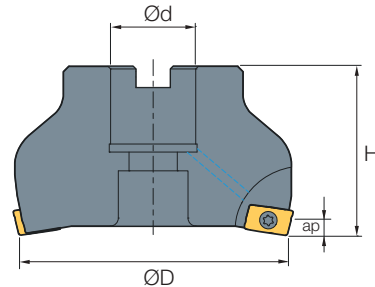

AP	DESCRIPTION 형번		STOCK 재고	DIMENSIONS 치수									
	D	H		d	ap	Z							
AP 16	MFA	75063R-16-4T	●	63	40	22	16	4T	ST-SC0257	ST-WRT08			
		75063R-16-4T-C	●	63	40	22	16	4T	ST-SC0257	ST-WRT08			
		75080R-16-6T	●	80	40	27	16	6T	ST-SC0257	ST-WRT08			
		75080R-16-6T-C	●	80	40	27	16	6T					
		75100R-16-7T	●	100	50	32	16	7T					
		75100R-16-7T-C	●	100	50	32	16	7T					

적용인서트 ▶ 236

MFAP

AP□□16

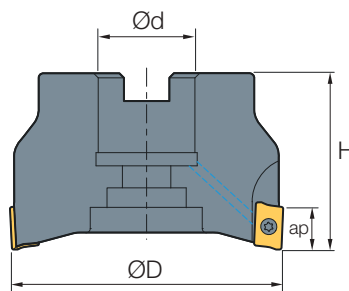

AP	DESCRIPTION 형번	STOCK 재고	DIMENSIONS 치수								
			D	H	d	ap	Z				
AP 16	MFAP 90040R-16-4T	●	40	40	16	16	4T	ST-SC0257	ST-WRT08		
	90040R-16-4T-C	●	40	40	22	16	4T	ST-SC0257	ST-WRT08		
	90050R-16-5T	●	50	40	22	16	5T	ST-SC0257	ST-WRT08		
	90050R-16-5T-C	●	50	40	22	16	5T	ST-SC0257	ST-WRT08		
	90063R-16-6T	●	63	40	22	16	6T	ST-SC0257	ST-WRT08		
	90063R-16-6T-C	●	63	40	22	16	6T	ST-SC0257	ST-WRT08		
	90080R-16-7T	●	80	50	22	16	7T	ST-SC0257	ST-WRT08		
	90080R-16-7T-C	●	80	50	22	16	7T	ST-SC0257	ST-WRT08		
	90100R-16-8T	●	100	50	32	16	8T	ST-SC0257	ST-WRT08		
	90100R-16-8T-C	●	100	50	32	16	8T	ST-SC0257	ST-WRT08		
	90125R-16-9T	●	125	63	40	16	9T	ST-SC0257	ST-WRT08		
	90160R-16-10T	●	160	63	40	16	10T	ST-SC0257	ST-WRT08		
	90200R-16-12T	●	200	63	60	16	12T	ST-SC0257	ST-WRT08		

carbide 236

MFAP

AP□□17

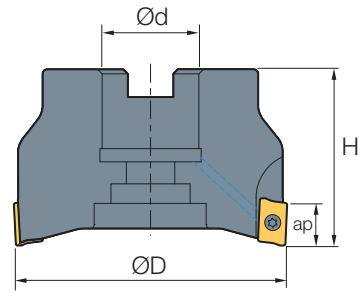

AP	DESCRIPTION 형번	STOCK 재고	DIMENSIONS 치수								
			D	H	d	ap	Z				
AP 17	MFAP 90050R-17-5T-C	●	50	40	22	16	5T	ST-SC0257	ST-WRT08		
	90063R-17-6T-C	●	63	40	22	16	6T	ST-SC0257	ST-WRT08		
	90080R-17-7T-C	●	80	50	22	16	7T	ST-SC0257	ST-WRT08		
	90100R-17-9T-C	●	100	50	32	16	8T	ST-SC0257	ST-WRT08		

터닝
그루빙
나사
밀링
인테그럴 드릴
엔드밀
슬리드 드릴
부품
색인표

MSRD

RD □□

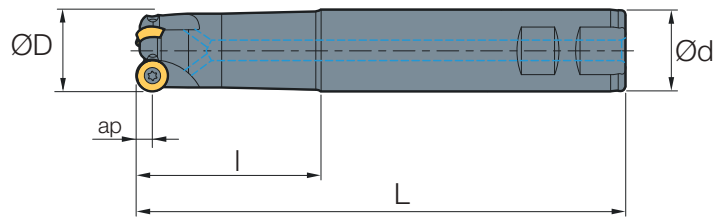

RD	DESCRIPTION 형번		STOCK 재고	DIMENSIONS 치수									
				D	L	l	d	Z	ap				
RD 08	MSRD	16-120-08-16-2T	●	16	120	55	20	2T	08	ST-SC0256	ST-WRT08		
		16-160-08-16-2T	●	16	160	55	25	2T	08	ST-SC0256	ST-WRT08		
		20-120-08-20-2T	●	20	120	55	25	2T	08	ST-SC0256	ST-WRT08		
		20-160-08-20-2T	●	20	160	55	25	2T	08	ST-SC0256	ST-WRT08		
		20-200-08-20-2T	●	20	200	55	25	2T	08	ST-SC0256	ST-WRT08		
		25-120-08-25-3T	●	25	120	55	25	3T	08	ST-SC0256	ST-WRT08		
		25-160-08-25-3T	●	25	160	55	25	3T	08	ST-SC0256	ST-WRT08		
		25-200-08-25-3T	●	25	200	55	25	3T	08	ST-SC0256	ST-WRT08		
		32-120-08-32-4T	●	32	120	55	25	4T	08	ST-SC0256	ST-WRT08		
		32-160-08-32-4T	●	32	160	55	25	4T	08	ST-SC0256	ST-WRT08		
		32-200-08-32-4T	●	32	200	55	25	4T	08	ST-SC0256	ST-WRT08		
RD 10	MSRD	20-120-10-20-2T	●	20	120	55	20	2T	10	ST-SC3508	ST-WRT15		
		20-160-10-20-2T	●	20	160	55	20	2T	10	ST-SC3508	ST-WRT15		
		20-200-10-20-2T	●	20	200	55	20	2T	10	ST-SC3508	ST-WRT15		
		25-120-10-25-2T	●	25	120	55	25	2T	10	ST-SC3508	ST-WRT15		
		25-160-10-25-2T	●	25	160	55	25	2T	10	ST-SC3508	ST-WRT15		
		25-200-10-25-2T	●	25	200	55	25	2T	10	ST-SC3508	ST-WRT15		
		32-120-10-32-3T	●	32	120	55	32	3T	10	ST-SC3508	ST-WRT15		
		32-160-10-32-3T	●	32	160	55	32	3T	10	ST-SC3508	ST-WRT15		
		32-200-10-32-3T	●	32	200	55	32	3T	10	ST-SC3508	ST-WRT15		
		40-120-10-32-4T	●	40	120	55	32	4T	10	ST-SC3508	ST-WRT15		
		40-160-10-32-4T	●	40	160	55	32	4T	10	ST-SC3508	ST-WRT15		
	40-200-10-32-4T	●	40	200	55	32	4T	10	ST-SC3508	ST-WRT15			

TURNING

GROOVING

THREADING

MILLING

DRILLING

ENDMILLS

DRILLS

SPARE PARTS

INDEX

carbide

239

터너

그루브

나사

밀링

인테셔널 드릴

엔드밀

슬리드 드릴

부품

색인표

MSRD

RD □□

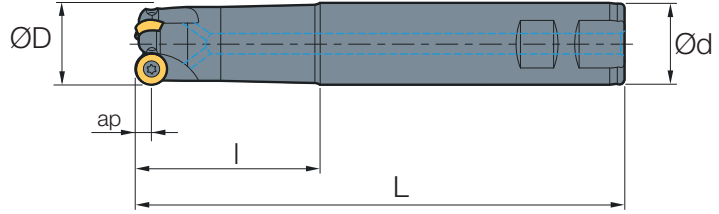



RD	DESCRIPTION 형번		STOCK 재고	DIMENSIONS 치수											
				D	L	l	d	Z	ap						
RD 12	MSRD	25-120-12-25-2T	●	25	120	55	25	2T	08	ST-SC3508	ST-WRT15				
		25-160-12-25-2T	●	25	160	55	25	2T	08	ST-SC3508	ST-WRT15				
		25-200-12-25-2T	●	25	200	55	25	2T	08	ST-SC3508	ST-WRT15				
		32-120-12-32-3T	●	32	120	55	32	3T	10	ST-SC3508	ST-WRT15				
		32-160-12-32-3T	●	32	160	55	32	3T	10	ST-SC3508	ST-WRT15				
		32-200-12-32-3T	●	32	200	55	32	3T	10	ST-SC3508	ST-WRT15				
		40-120-12-32-4T	●	40	120	55	32	4T	10	ST-SC3508	ST-WRT15				
		40-200-12-32-4T	●	40	200	55	32	4T	10	ST-SC3508	ST-WRT15				

적용인서트 ▶  239

MMRD

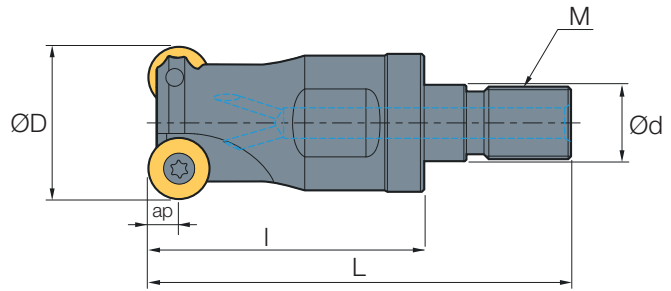
RD□□



RD	DESCRIPTION 형번		STOCK 재고	DIMENSIONS 치수											
	D	L		l	d	Z	ap	M							
RD 08	MMRD	16-M08-08-2T-C	●	16	52	23	13	2T	4	08	ST-SC0256	ST-WRT08			
		20-M10-08-3T-C	●	20	52	30	18	3T	4	10	ST-SC0256	ST-WRT08			
		25-M12-08-4T-C	●	25	52	35	21	4T	4	12	ST-SC0256	ST-WRT08			
RD 10	MMRD	20-M10-10-2T-C	●	20	52	30	18	2T	5	10	ST-SC3508	ST-WRT15			
		25-M12-10-3T-C	●	25	52	35	21	3T	5	12	ST-SC3508	ST-WRT15			
		30-M16-10-3T-C	●	30	64	43	29	3T	5	16	ST-SC3508	ST-WRT15			
		32-M16-10-4T-C	●	32	64	43	29	4T	5	16	ST-SC3508	ST-WRT15			
		35-M16-10-4T-C	●	35	64	43	29	4T	5	16	ST-SC3508	ST-WRT15			
		40-M16-10-4T-C	●	40	67	43	29	4T	5	16	ST-SC3508	ST-WRT15			
		42-M16-10-5T-C	●	42	67	43	29	4T	5	16	ST-SC3508	ST-WRT15			
RD 12	MMRD	24-M12-12-2T-C	●	24	52	35	21	2T	6	12	ST-SC3508	ST-WRT15			
		25-M12-12-2T-C	●	25	52	35	21	2T	6	12	ST-SC3508	ST-WRT15			
		32-M16-12-3T-C	●	32	64	43	29	3T	6	16	ST-SC3508	ST-WRT15			
		35-M16-12-3T-C	●	35	64	43	29	3T	6	16	ST-SC3508	ST-WRT15			
		40-M16-12-4T-C	●	40	67	43	29	4T	6	16	ST-SC3508	ST-WRT15			
		42-M16-12-4T-C	●	42	67	43	29	4T	6	16	ST-SC3508	ST-WRT15			

carbide ▶ 239

- TURNING
- GROOVING
- THREADING
- MILLING
- DRILLING
- ENDMILLS
- DRILLS
- SPARE PARTS
- INDEX

MFRD

RD□□

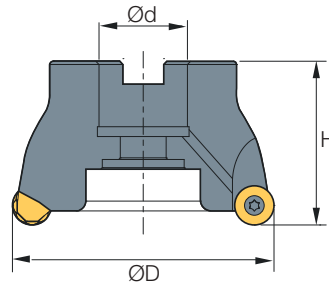

RD	DESCRIPTION 형번		STOCK 재고	DIMENSIONS 치수								
				D	H	d	ap	Z				
RD 10	MFRD	040R-10-4T	●	40	40	16	5	4T	ST-SC3509	ST-WRT15		
		040R-10-4T-C	●	40	40	16	5	4T	ST-SC3509	ST-WRT15		
		050R-10-5T	●	50	50	22	5	5T	ST-SC3509	ST-WRT15		
		050R-10-5T-C	●	50	50	22	5	5T	ST-SC3509	ST-WRT15		
		063R-10-6T	●	63	50	27	5	6T	ST-SC3509	ST-WRT15		
		063R-10-6T-C	●	63	50	27	5	6T	ST-SC3509	ST-WRT15		
		080R-10-7T	●	80	50	27	5	7T	ST-SC3509	ST-WRT15		
		080R-10-7T-C	●	80	50	27	5	7T	ST-SC3509	ST-WRT15		
		100R-10-8T	●	100	50	32	5	8T	ST-SC3509	ST-WRT15		
		100R-10-8T-C	●	100	50	32	5	8T	ST-SC3509	ST-WRT15		
	125R-10-9T	●	125	63	40	5	9T	ST-SC3509	ST-WRT15			
RD 12	MFRD	040R-12-4T	●	40	40	16	6	4T	ST-SC3509	ST-WRT15		
		040R-12-4T-C	●	40	40	16	6	4T	ST-SC3509	ST-WRT15		
		050R-12-5T	●	50	50	22	6	5T	ST-SC3509	ST-WRT15		
		050R-12-5T-C	●	50	50	22	6	5T	ST-SC3509	ST-WRT15		
		063R-12-6T	●	63	50	27	6	6T	ST-SC3509	ST-WRT15		
		063R-12-6T-C	●	63	50	27	6	6T	ST-SC3509	ST-WRT15		
		080R-12-7T	●	80	50	27	6	7T	ST-SC3509	ST-WRT15		
		080R-12-7T-C	●	80	50	27	6	7T	ST-SC3509	ST-WRT15		
		100R-12-8T	●	100	50	32	6	8T	ST-SC3509	ST-WRT15		
		100R-12-8T-C	●	125	50	32	6	8T	ST-SC3509	ST-WRT15		
	125R-12-9T	●	125	63	40	6	9T	ST-SC3509	ST-WRT15			

적용인서트

▶ 239

MFSE

SE □ □ 12

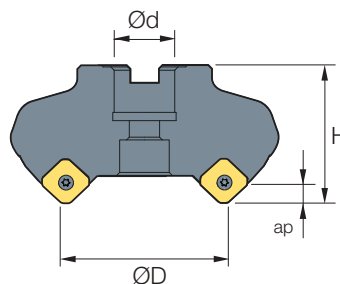

SE	DESCRIPTION 형번		STOCK 재고	DIMENSIONS 치수							
	MFSE			D	H	d	ap	Z			
SE 12	45050R-4T		●	40	40	22	6	4T	ST-SC0359	ST-WRT15	
	45050R-4T-C		●	40	40	22	6	4T	ST-SC0359	ST-WRT15	
	45063R-5T		●	63	40	22	6	5T	ST-SC0359	ST-WRT15	
	45063R-5T-C		●	63	40	22	6	5T	ST-SC0359	ST-WRT15	
	45080R-6T		●	80	50	27	6	6T	ST-SC0359	ST-WRT15	
	45080R-6T-C		●	80	50	27	6	6T	ST-SC0359	ST-WRT15	
	45100R-7T		●	100	50	32	6	7T	ST-SC0359	ST-WRT15	
	45100R-7T-C		●	100	50	32	6	7T	ST-SC0359	ST-WRT15	
	45125R-8T		●	125	63	40	6	8T	ST-SC0359	ST-WRT15	
	45160R-10T		●	160	63	40	6	10T	ST-SC0359	ST-WRT15	

TURNING

GROOVING

THREADING

MILLING

DRILLING

ENDMILLS

DRILLS

SPARE PARTS

INDEX

carbide ▶ 243

MFSN

SN□□12

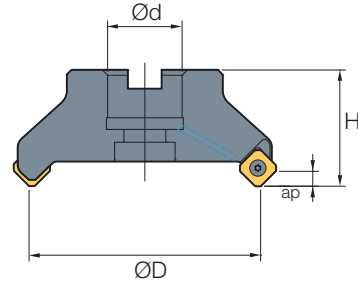

SN	DESCRIPTION 형번	STOCK 재고	DIMENSIONS 치수								
			D	H	d	ap	Z				
SN 12	MFSN 45050R-5T	●	50	40	22	6	5T	ST-SC0411	ST-WRT15		
	45050R-5T-C	●	50	40	22	6	5T	ST-SC0411	ST-WRT15		
	45063R-7T	●	63	40	22	6	7T	ST-SC0411	ST-WRT15		
	45063R-7T-C	●	63	40	22	6	7T	ST-SC0411	ST-WRT15		
	45080R-8T	●	80	50	27	6	8T	ST-SC0411	ST-WRT15		
	45080R-8T-C	●	80	50	27	6	8T	ST-SC0411	ST-WRT15		
	45100R-10T	●	100	50	32	6	10T	ST-SC0411	ST-WRT15		
	45100R-10T-C	●	100	50	32	6	10T	ST-SC0411	ST-WRT15		
	45125R-11T	●	125	63	40	6	11T	ST-SC0411	ST-WRT15		
	45160R-12T	●	160	63	40	6	12T	ST-SC0411	ST-WRT15		
	45200R-14T	●	200	63	60	6	14T	ST-SC0411	ST-WRT15		

적용인서트 244

터닝
그루브
나사
밀링
인테서블 드릴
엔드밀
솔리드 드릴
부품
색인표

MFTP

TP □□

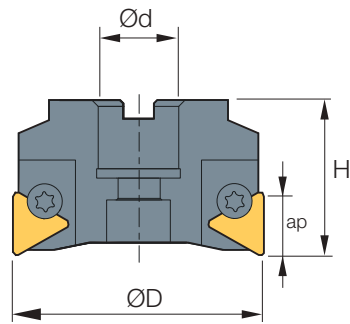

TURNING

GROOVING

THREADING

MILLING

DRILLING

ENDMILLS

DRILLS

SPARE PARTS

INDEX

TP	DESCRIPTION 형번	STOCK 재고	DIMENSIONS 치 수								
			D	H	d	ap	Z				
TP 16	MFTP 90050R-16-4T	●	50	40	22	12	4T	ST-SC0610	ST-WR0040		
	90063R-16-5T	●	63	45	22	12	5T	ST-SC0610	ST-WR0040		
	90080R-16-6T	●	80	50	27	12	6T	ST-SC0610	ST-WR0040		
	90100R-16-7T	●	100	50	32	12	7T	ST-SC0610	ST-WR0040		
	90125R-16-8T	●	125	63	40	12	8T	ST-SC0610	ST-WR0040		
	90160R-16-9T	●	160	63	40	12	9T	ST-SC0610	ST-WR0040		
TP 22	MFTP 90063R-22-3T	●	63	45	22	18	3T	ST-SC0810	ST-WR0050		
	90063R-22-4T	●	63	45	22	18	4T	ST-SC0810	ST-WR0050		
	90080R-22-5T	●	80	50	27	18	5T	ST-SC0810	ST-WR0050		
	90100R-22-6T	●	100	50	32	18	6T	ST-SC0810	ST-WR0050		
	90125R-22-7T	●	125	63	40	18	7T	ST-SC0810	ST-WR0050		
	90160R-22-8T	●	160	63	40	18	8T	ST-SC0810	ST-WR0050		
	90200R-22-11T	●	200	63	60	18	11T	ST-SC0810	ST-WR0050		

carbide 246



MAT

Steel Shaft

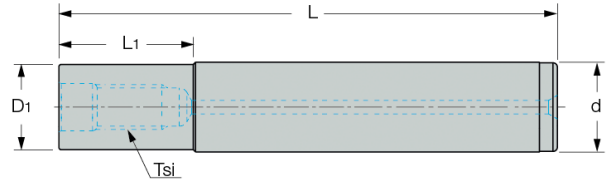

	DESCRIPTION 형번	STOCK 재고	DIMENSIONS 치수								
			D	d	L	I	M				
MAT	M10-120-S18/20	●	18	20	120	60	10				
	M10-170-S18/20	●	18	20	170	90	10				
	M16-160-S24/25	●	24	25	160	80	16				
	M16-200-S24/25	●	24	25	200	100	16				
	M16-250-S24/25	●	24	25	250	150	16				
	M16-160-S31/32	●	31	32	160	80	16				
	M16-200-S31/32	●	31	32	200	100	16				
	M16-250-S31/32	●	31	32	250	150	16				

MFT

Carbide Shaft

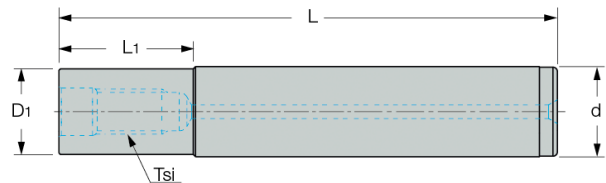

	DESCRIPTION 형번	STOCK 재고	DIMENSIONS 치수								
			D	d	L	I	M				
MFT	08-08-100-M4	●	8	8	100	-	M4				
	10-10-080-M5	●	10	10	80	-	M5				
	10-10-100-M5	●	10	10	100	-	M5				
	10-10-100-M6	●	10	10	100	-	M6				
	10-10-150-M5	●	10	10	150	-	M5				
	12-12-100-M6	●	12	12	100	-	M6				
	12-12-150-M6	●	12	12	150	-	M6				
	12-12-200-M6	●	12	12	200	-	M6				

MFT

Carbide Shaft

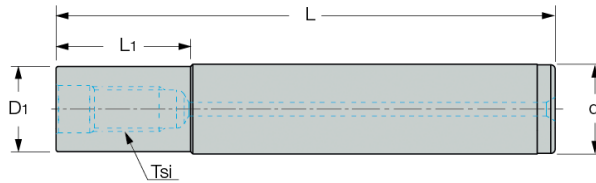

	DESCRIPTION 형번	STOCK 재고	DIMENSIONS 치수								
			D	d	L	I	M				
MFT	16-15-100-M8	●	16	15	100	50	M8				
	16-15-150-M8	●	16	15	150	50	M8				
	16-15-200-M8	●	16	15	200	50	M8				
	17-16-100-M8	●	16	16	100	-	M8				
	17-16-150-M8	●	16	16	150	-	M8				
	17-16-200-M8	●	16	16	200	-	M8				
	17-16-250-M8	●	16	16	250	-	M8				
	17-16-300-M8	●	16	16	300	-	M8				
	20-19-150-M10	●	20	19	150	50	M10				
	20-19-250-M10	●	20	19	250	100	M10				
	21-20-100-M10	●	20	20	100	-	M10				
	21-20-150-M10	●	20	20	150	-	M10				
	21-20-200-M10	●	20	20	200	-	M10				
	21-20-250-M10	●	20	20	250	-	M10				
	21-20-300-M10	●	20	20	300	-	M10				
	25-24-150-M12	●	25	24	150	50	M12				
	25-24-200-M12	●	25	24	200	50	M12				
	25-24-250-M12	●	25	24	250	100	M12				
	25-24-300-M12	●	25	24	300	100	M12				
	26-25-150-M12	●	25	25	150	-	M12				
	26-25-200-M12	●	25	25	200	-	M12				
	26-25-250-M12	●	25	25	250	-	M12				
	26-25-300-M12	●	25	25	300	-	M12				
	35-32-150-M16	●	35	32	150	50	M16				
	35-32-200-M16	●	35	32	200	50	M16				
	35-32-250-M16	●	35	32	250	100	M16				
	35-32-300-M16	●	35	32	300	100	M16				
	35-32-350-M16	●	35	32	350	150	M16				
	35-32-400-M16	●	35	32	400	200	M16				

TURNING

GROOVING

THREADING

MILLING

DRILLING

ENDMILLS

DRILLS

SPARE PARTS

INDEX

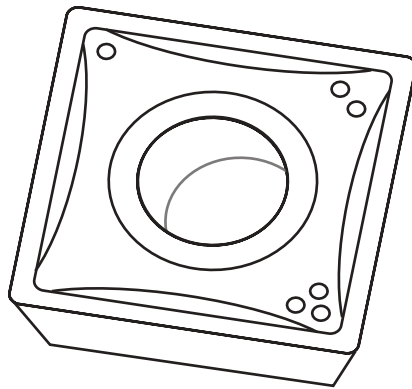

DRILLING/ 드릴링

carbide 인서트/275

holders 홀더 /279

DRILLING / carbide
드릴링 / 인서트

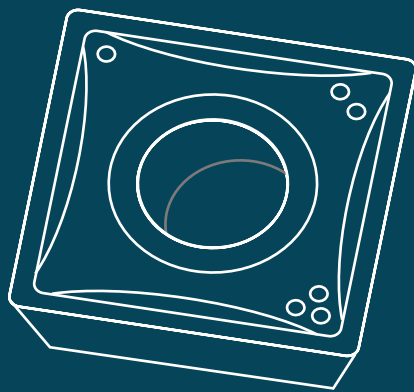

Grades 재종

ISO DIN 513	K					P					M					N				
	K01	K10	K20	K30	K40	P01	P10	P20	P30	P40	M01	M10	M20	M30	M40	N01	N10	N20	N30	N40
CARBIDE CVD																				
CARBIDE PVD																				
CARBIDE UNCOATED																				
CERMET UNCOATED																				

드릴링 DRILLING

POSITIVE 11°
with hole

SP □□

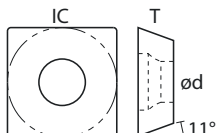

SP	0502	0602	07T3	0904	1104	1405
IC	5,00	6,00	7,94	9,80	11,50	14,30
T	2,38	2,38	3,97	4,30	4,76	5,56
Ød	2,25	2,61	2,85	4,05	4,45	5,75

DESCRIPTION 형 번		CARBIDEPVD						
		TP5025	TP0525	TP0535	TP0025	TP0015P		
	SPMG050204-TT	●	●	●	●	●		
	SPMG060204-TT	●	●	●	●	●		
	SPMG07T308-TT	●	●	●	●	●		
	SPMG090408-TT	●	●	●	●	●		
	SPMG110408-TT	●	●	●	●	●		
	SPMG140512-TT	●	●	●	●	●		

- TURNING
- GROOVING
- THREADING
- MILLING
- DRILLING
- ENDMILLS
- DRILLS
- SPARE PARTS
- INDEX

터닝

그루비

나사

미링

인테셔널 드릴

엔드밀

솔리드 드릴

부품

색인표

**POSITIVE 7°
with hole**

WC □ □

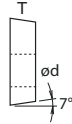

WC	0302	0402	0503	06T3	0804
IC	5,56	6,35	7,94	9,525	12,70
T	2,38	2,38	3,18	3,97	4,76
Ød	TT	2,50	2,80	3,40	4,40
	TK	2,80	3,00	3,40	3,80
	TK1	2,80	3,00	3,40	3,80

DESCRIPTION		CARBIDE/PVD												
		TP5025	TP0525	TP0025	TP0015P	TP0115P								
	WCGX030208-TK		●											
	WCGX040208-TK		●											
	WCGX050308-TK		●											
	WCGX06T308-TK		●											
	WCGX080412-TK		●											
	WCGX030208-TK1				●	●								
	WCGX040208-TK1				●	●								
	WCGX050308-TK1				●	●								
	WCGX06T308-TK1				●	●								
	WCGX080412-TK1				●	●								
	WCGX030204-TT		●											
	WCGX030208-TT		●											
	WCGX040204-TT		●											
	WCGX040208-TT		●											
	WCGX050308-TT		●											
	WCGX06T308-TT		●											
	WCGX080408-TT		●											
	WCGX080412-TT		●											

DRILLING / holders



드릴링 홀더

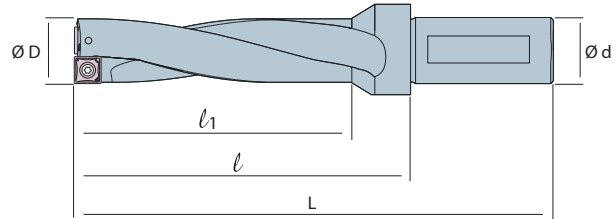

SPID / T-DRILL

2xD SP □□



SP	DESCRIPTION 형번		STOCK 재고	DIMENSIONS 치수					 			
	SPID	형번		ØD	Ød	L	l	l ₁				
SPMG0502	SPID	125-2D-S20-SP05	●	12.5	20	107	37	44	ST-SC0206	ST-WRT06		
		130-2D-S20-SP05	●	13	20	107	39	44	ST-SC0206	ST-WRT06		
		135-2D-S20-SP05	●	13.5	20	110	40.5	46	ST-SC0206	ST-WRT06		
		140-2D-S20-SP05	●	14	20	110	42	46	ST-SC0206	ST-WRT06		
		145-2D-S20-SP05	●	14.5	20	113	43.5	49	ST-SC0206	ST-WRT06		
		150-2D-S20-SP05	●	15	20	113	45	49	ST-SC0206	ST-WRT06		
SPMG0602	SPID	155-2D-S20-SP06	●	15.5	20	124	46.5	52	ST-SC0226	ST-WRT07		
		160-2D-S25-SP06	●	16	25	124	48	52	ST-SC0226	ST-WRT07		
		165-2D-S25-SP06	●	16.5	25	127	49.5	54	ST-SC0226	ST-WRT07		
		170-2D-S25-SP06	●	17	25	127	51	54	ST-SC0226	ST-WRT07		
		175-2D-S25-SP06	●	17.5	25	130	52.5	57	ST-SC0226	ST-WRT07		
		180-2D-S25-SP06	●	18	25	130	54	57	ST-SC0226	ST-WRT07		
		185-2D-S25-SP06	●	18.5	25	134	55.5	59	ST-SC0226	ST-WRT07		
		190-2D-S25-SP06	●	19	25	134	57	59	ST-SC0226	ST-WRT07		
		195-2D-S25-SP06	●	19.5	25	139	58.5	63	ST-SC0226	ST-WRT07		
		200-2D-S25-SP06	●	20	25	139	60	63	ST-SC0226	ST-WRT07		
		205-2D-S25-SP06	●	20.5	25	142	61.5	65	ST-SC0226	ST-WRT07		
		210-2D-S25-SP06	●	21	25	142	63	65	ST-SC0226	ST-WRT07		
SPMG07T3	SPID	215-2D-S25-SP06	●	21.5	25	145	64.5	67	ST-SC0257	ST-WRT07		
		220-2D-S25-SP07	●	22	25	145	66	67	ST-SC0257	ST-WRT08		
		225-2D-S25-SP07	●	22.5	25	150	67.5	71	ST-SC0257	ST-WRT08		
		230-2D-S25-SP07	●	23	25	150	69	71	ST-SC0257	ST-WRT08		
		235-2D-S25-SP07	●	23.5	25	154	70.5	74	ST-SC0257	ST-WRT08		
		240-2D-S25-SP07	●	24	25	158	72	74	ST-SC0257	ST-WRT08		
		245-2D-S25-SP07	●	24.5	25	158	73.5	77	ST-SC0257	ST-WRT08		
		250-2D-S25-SP07	●	25	25	161	75	77	ST-SC0257	ST-WRT08		
		255-2D-S25-SP07	●	25.5	25	161	76.5	79	ST-SC0257	ST-WRT08		
	260-2D-S25-SP07	●	26	25	164	78	79	ST-SC0257	ST-WRT08			

터너
그라운드
나사
원형
인테그럴 드릴
엔드밀
슬리드 드릴
부품
색인표

SPID / T-DRILL

2xD

SP □□

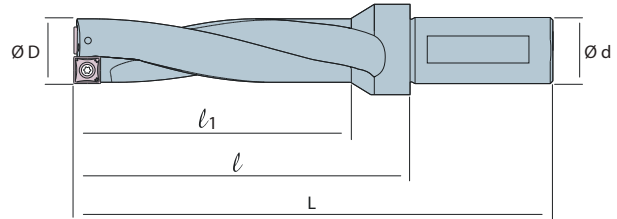

SP	DESCRIPTION 형번		STOCK 재고	DIMENSIONS 치수								
	SPID			ØD	Ød	L	l	l ₁				
SPMG07T3	SPID	265-2D-S25-SP07	●	26.5	25	137	53	81	ST-SC0257	ST-WRT08		
		270-2D-S25-SP07	●	27	25	137	54	81	ST-SC0257	ST-WRT08		
		275-2D-S25-SP07	●	27.5	25	140	55	84	ST-SC0257	ST-WRT08		
SPMG0904	SPID	280-2D-S25-SP09	●	28	25	140	56	84	ST-SC3511	ST-WRT15		
		285-2D-S25-SP09	●	28.5	25	142	57	86	ST-SC3511	ST-WRT15		
		290-2D-S25-SP09	●	29	25	142	58	86	ST-SC3511	ST-WRT15		
		295-2D-S25-SP09	●	29.5	25	147	59	91	ST-SC3511	ST-WRT15		
		300-2D-S32-SP09	●	30	32	151	60	91	ST-SC3511	ST-WRT15		
		310-2D-S32-SP09	●	31	32	154	62	94	ST-SC3511	ST-WRT15		
		320-2D-S32-SP09	●	32	32	156	64	96	ST-SC3511	ST-WRT15		
		330-2D-S32-SP09	●	33	32	159	66	99	ST-SC3511	ST-WRT15		
SPMG1104	SPID	340-2D-S32-SP11	●	34	32	161	68	101	ST-SC0411	ST-WRT15		
		350-2D-S32-SP11	●	35	32	164	70	104	ST-SC0411	ST-WRT15		
		360-2D-S32-SP11	●	36	32	167	72	107	ST-SC0411	ST-WRT15		
		370-2D-S32-SP11	●	37	32	170	74	110	ST-SC0411	ST-WRT15		
		380-2D-S32-SP11	●	38	32	173	76	113	ST-SC0411	ST-WRT15		
		390-2D-S32-SP11	●	39	32	175	78	115	ST-SC0411	ST-WRT15		
		400-2D-S32-SP11	●	40	32	178	80	118	ST-SC0411	ST-WRT15		
		410-2D-S32-SP11	●	41	32	181	82	121	ST-SC0411	ST-WRT15		
SPMG1405	SPID	420-2D-S32-SP14	●	42	32	183	84	123	ST-SC0511	ST-WRT20		
		430-2D-S32-SP14	●	43	32	186	86	126	ST-SC0511	ST-WRT20		
		440-2D-S32-SP14	●	44	32	188	88	128	ST-SC0511	ST-WRT20		
		450-2D-S40-SP14	●	45	40	202	90	132	ST-SC0511	ST-WRT20		
		460-2D-S40-SP14	●	46	40	205	92	135	ST-SC0511	ST-WRT20		
		470-2D-S40-SP14	●	47	40	207	94	137	ST-SC0511	ST-WRT20		
		480-2D-S40-SP14	●	48	40	210	96	140	ST-SC0511	ST-WRT20		
		490-2D-S40-SP14	●	49	40	212	98	142	ST-SC0511	ST-WRT20		
	500-2D-S40-SP14	●	50	40	215	140	145	ST-SC0511	ST-WRT20			

TURNING

GROOVING

THREADING

MILLING

DRILLING

ENDMILLS

DRILLS

SPARE PARTS



INDEX

SPID / T-DRILL

3xD

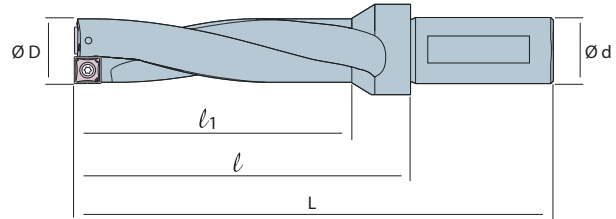
SP □□





SP	DESCRIPTION 형번		STOCK 재고	DIMENSIONS 치수					 			
	SPID	형번		ØD	Ød	L	l	L ₁				
SPMG0502	SPID	125-3D-S20-SP05	●	12.5	20	94	25	57	ST-SC0206	ST-WRT06		
		130-3D-S20-SP05	●	13	20	94	26	57	ST-SC0206	ST-WRT06		
		135-3D-S20-SP05	●	13.5	20	96	27	60	ST-SC0206	ST-WRT06		
		140-3D-S20-SP05	●	14	20	96	28	60	ST-SC0206	ST-WRT06		
		145-3D-S20-SP05	●	14.5	20	99	29	63	ST-SC0206	ST-WRT06		
		150-3D-S20-SP05	●	15	20	99	30	63	ST-SC0206	ST-WRT06		
SPMG0602	SPID	155-3D-S20-SP06	●	15.5	20	102	31	68	ST-SC0226	ST-WRT07		
		160-3D-S25-SP06	●	16	25	108	32	68	ST-SC0226	ST-WRT07		
		165-3D-S25-SP06	●	16.5	25	110	33	71	ST-SC0226	ST-WRT07		
		170-3D-S25-SP06	●	17	25	110	34	71	ST-SC0226	ST-WRT07		
		175-3D-S25-SP06	●	17.5	25	113	35	75	ST-SC0226	ST-WRT07		
		180-3D-S25-SP06	●	18	25	113	36	75	ST-SC0226	ST-WRT07		
		185-3D-S25-SP06	●	18.5	25	115	37	78	ST-SC0226	ST-WRT07		
		190-3D-S25-SP06	●	19	25	115	38	78	ST-SC0226	ST-WRT07		
		195-3D-S25-SP06	●	19.5	25	119	39	83	ST-SC0226	ST-WRT07		
		200-3D-S25-SP06	●	20	25	119	40	83	ST-SC0226	ST-WRT07		
		205-3D-S25-SP06	●	20.5	25	121	41	86	ST-SC0226	ST-WRT07		
		210-3D-S25-SP06	●	21	25	121	42	86	ST-SC0226	ST-WRT07		
SPMG07T3	SPID	220-3D-S25-SP07	●	22	25	123	44	89	ST-SC0257	ST-WRT08		
		225-3D-S25-SP07	●	22.5	25	127	45	94	ST-SC0257	ST-WRT08		
		230-3D-S25-SP07	●	23	25	127	46	94	ST-SC0257	ST-WRT08		
		235-3D-S25-SP07	●	23.5	25	130	47	98	ST-SC0257	ST-WRT08		
		240-3D-S25-SP07	●	24	25	130	48	98	ST-SC0257	ST-WRT08		
		245-3D-S25-SP07	●	24.5	25	133	49	102	ST-SC0257	ST-WRT08		
		250-3D-S25-SP07	●	25	25	133	50	102	ST-SC0257	ST-WRT08		
		255-3D-S25-SP07	●	25.5	25	135	51	105	ST-SC0257	ST-WRT08		
		260-3D-S25-SP07	●	26	25	135	52	105	ST-SC0257	ST-WRT08		

SPID / T-DRILL

3xD

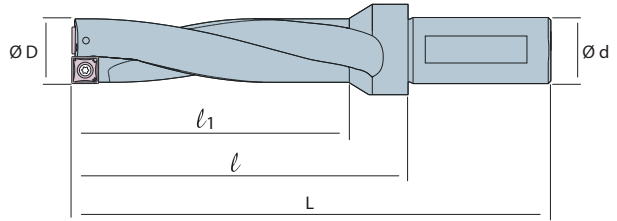
SP □□



SP	DESCRIPTION 형번		STOCK 재고	DIMENSIONS 치수					 ← 			
				ØD	Ød	L	l	l ₁				
SPMG07T3	SPID	265-3D-S25-SP07	●	26.5	25	164	79.5	108	ST-SC0257	ST-WRT08		
		270-3D-S25-SP07	●	27	25	164	81	108	ST-SC0257	ST-WRT08		
		275-3D-S25-SP07	●	27.5	25	168	82.5	112	ST-SC0257	ST-WRT08		
SPMG0904	SPID	280-3D-S25-SP09	●	28	25	168	84	112	ST-SC3511	ST-WRT15		
		285-3D-S25-SP09	●	28.5	25	171	85.5	115	ST-SC3511	ST-WRT15		
		290-3D-S25-SP09	●	29	25	171	87	115	ST-SC3511	ST-WRT15		
		295-3D-S25-SP09	●	29.5	25	177	88.5	121	ST-SC3511	ST-WRT15		
		300-3D-S32-SP09	●	30	32	181	90	121	ST-SC3511	ST-WRT15		
		310-3D-S32-SP09	●	31	32	185	93	125	ST-SC3511	ST-WRT15		
		320-3D-S32-SP09	●	32	32	188	96	128	ST-SC3511	ST-WRT15		
SPMG1104	SPID	340-3D-S32-SP11	●	34	32	195	102	135	ST-SC0411	ST-WRT15		
		350-3D-S32-SP11	●	35	32	199	105	139	ST-SC0411	ST-WRT15		
		360-3D-S32-SP11	●	36	32	203	108	143	ST-SC0411	ST-WRT15		
		370-3D-S32-SP11	●	37	32	207	111	147	ST-SC0411	ST-WRT15		
		380-3D-S32-SP11	●	38	32	211	114	151	ST-SC0411	ST-WRT15		
		390-3D-S32-SP11	●	39	32	214	117	154	ST-SC0411	ST-WRT15		
		400-3D-S32-SP11	●	40	32	218	120	158	ST-SC0411	ST-WRT15		
		410-3D-S32-SP11	●	41	32	222	123	162	ST-SC0411	ST-WRT15		
SPMG1405	SPID	420-3D-S32-SP14	●	42	32	225	126	165	ST-SC0511	ST-WRT20		
		430-3D-S32-SP14	●	43	32	229	129	169	ST-SC0511	ST-WRT20		
		440-3D-S32-SP14	●	44	32	232	132	172	ST-SC0511	ST-WRT20		
		450-3D-S40-SP14	●	45	40	247	135	177	ST-SC0511	ST-WRT20		
		460-3D-S40-SP14	●	46	40	251	138	181	ST-SC0511	ST-WRT20		
		470-3D-S40-SP14	●	47	40	254	141	184	ST-SC0511	ST-WRT20		
		480-3D-S40-SP14	●	48	40	258	144	188	ST-SC0511	ST-WRT20		
		490-3D-S40-SP14	●	49	40	261	147	191	ST-SC0511	ST-WRT20		
		500-3D-S40-SP14	●	50	40	265	150	195	ST-SC0511	ST-WRT20		
		510-3D-S40-SP14	●	51	40	268	153	198	ST-SC0511	ST-WRT20		
		520-3D-S40-SP14	●	52	40	271	156	201	ST-SC0511	ST-WRT20		
		530-3D-S40-SP14	●	53	40	274	159	204	ST-SC0511	ST-WRT20		
	540-3D-S40-SP14	●	54	40	277	162	207	ST-SC0511	ST-WRT20			

TURNING

GROOVING

THREADING

MILLING

DRILLING

ENDMILLS

DRILLS



SPARE PARTS

INDEX

SPID / T-DRILL

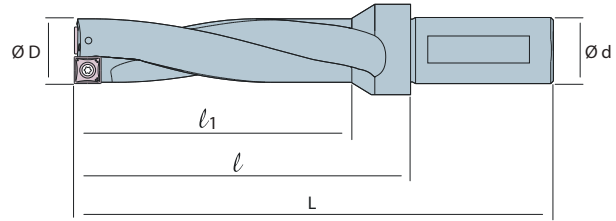
4xD SP □□



SP	DESCRIPTION 형번	STOCK 재고	DIMENSIONS 치수					 ← 			
			ØD	Ød	L	l	l ₁				
SPMG0502	SPID 125-4D-S20-SP05	●	12.5	20	120	52	70	ST-SC0206	ST-WRT06		
	130-4D-S20-SP05	●	13	20	120	52	70	ST-SC0206	ST-WRT06		
	135-4D-S20-SP05	●	13.5	20	120	52	70	ST-SC0206	ST-WRT06		
	140-4D-S20-SP05	●	14	20	124	56	76	ST-SC0206	ST-WRT06		
	145-4D-S20-SP05	●	14.5	20	124	56	76	ST-SC0206	ST-WRT06		
	150-4D-S20-SP05	●	15	20	128	60	80	ST-SC0206	ST-WRT06		
SPMG0602	SPID 155-4D-S20-SP06	●	15.5	20	128	60	80	ST-SC0226	ST-WRT07		
	160-4D-S25-SP06	●	16	25	140	64	84	ST-SC0226	ST-WRT07		
	165-4D-S25-SP06	●	16.5	25	140	64	84	ST-SC0226	ST-WRT07		
	170-4D-S25-SP06	●	17	25	144	68	88	ST-SC0226	ST-WRT07		
	175-4D-S25-SP06	●	17.5	25	144	68	88	ST-SC0226	ST-WRT07		
	180-4D-S25-SP06	●	18	25	149	72	92	ST-SC0226	ST-WRT07		
	185-4D-S25-SP06	●	18.5	25	149	72	92	ST-SC0226	ST-WRT07		
	190-4D-S25-SP06	●	19	25	153	76	97	ST-SC0226	ST-WRT07		
	950-4D-S25-SP06	●	19.5	25	153	76	97	ST-SC0226	ST-WRT07		
	200-4D-S25-SP06	●	20	25	159	80	103	ST-SC0226	ST-WRT07		
	205-4D-S25-SP06	●	20.5	25	159	80	103	ST-SC0226	ST-WRT07		
	210-4D-S25-SP06	●	21	25	163	84	107	ST-SC0226	ST-WRT07		
SPMG07T3	SPID 220-4D-S25-SP07	●	22	25	167	88	111	ST-SC0257	ST-WRT08		
	225-4D-S25-SP07	●	22.5	25	167	88	111	ST-SC0257	ST-WRT08		
	230-4D-S25-SP07	●	23	25	173	92	117	ST-SC0257	ST-WRT08		
	235-4D-S25-SP07	●	23.5	25	173	92	117	ST-SC0257	ST-WRT08		
	240-4D-S25-SP07	●	24	25	178	96	122	ST-SC0257	ST-WRT08		
	245-4D-S25-SP07	●	24.5	25	178	96	122	ST-SC0257	ST-WRT08		
	250-4D-S25-SP07	●	25	25	183	100	127	ST-SC0257	ST-WRT08		
	255-4D-S25-SP07	●	25.5	25	183	100	127	ST-SC0257	ST-WRT08		
	260-4D-S25-SP07	●	26	25	187	104	131	ST-SC0257	ST-WRT08		
	265-4D-S25-SP07	●	26.5	25	187	104	131	ST-SC0257	ST-WRT08		
	270-4D-S25-SP07	●	27	25	191	108	135	ST-SC0257	ST-WRT08		
	275-4D-S25-SP07	●	27.5	25	191	108	135	ST-SC0257	ST-WRT08		

SPID / T-DRILL

4xD

SP □□

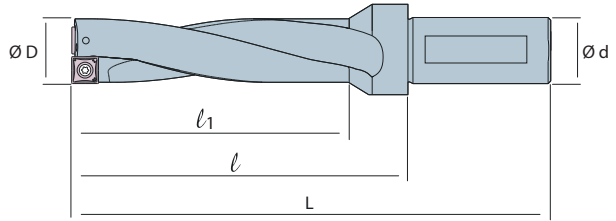

- TURNING
- GROOVING
- THREADING
- MILLING
- DRILLING
- ENDMILLS
- DRILLS
- SPARE PARTS
- INDEX

SP	DESCRIPTION 형번		STOCK 재고	DIMENSIONS 치수								
				ØD	Ød	L	l	l ₁				
SPMG0904	SPID	280-4D-S25-SP09	●	28	25	196	112	140	ST-SC3511	ST-WRT15		
		285-4D-S25-SP09	●	28.5	25	196	112	140	ST-SC3511	ST-WRT15		
		290-4D-S25-SP09	●	29	25	200	116	144	ST-SC3511	ST-WRT15		
		295-4D-S25-SP09	●	29.5	25	200	116	144	ST-SC3511	ST-WRT15		
		300-4D-S32-SP09	●	30	32	211	120	151	ST-SC3511	ST-WRT15		
		310-4D-S32-SP09	●	31	32	216	124	156	ST-SC3511	ST-WRT15		
		320-4D-S32-SP09	●	32	32	220	128	160	ST-SC3511	ST-WRT15		
		330-4D-S32-SP09	●	33	32	225	132	165	ST-SC3511	ST-WRT15		
		335-4D-S32-SP09	●	33.5	32	227	134	137	ST-SC0411	ST-WRT15		
SPMG1104	SPID	340-4D-S32-SP11	●	34	32	229	136	169	ST-SC0411	ST-WRT15		
		350-4D-S32-SP11	●	35	32	234	140	174	ST-SC0411	ST-WRT15		
		360-4D-S32-SP11	●	36	32	239	144	179	ST-SC0411	ST-WRT15		
		370-4D-S32-SP11	●	37	32	244	148	184	ST-SC0411	ST-WRT15		
		380-4D-S32-SP11	●	38	32	249	152	189	ST-SC0411	ST-WRT15		
		385-4D-S32-SP11	●	38.5	32	251	154	191	ST-SC0411	ST-WRT15		
		390-4D-S32-SP11	●	39	32	253	156	193	ST-SC0411	ST-WRT15		
		400-4D-S32-SP11	●	40	32	258	160	198	ST-SC0411	ST-WRT15		
		410-4D-S32-SP11	●	41	32	263	164	203	ST-SC0411	ST-WRT15		
SPMG1405	SPID	420-4D-S32-SP14	●	42	32	267	168	207	ST-SC0511	ST-WRT20		
		430-4D-S32-SP14	●	43	32	272	172	212	ST-SC0511	ST-WRT20		
		440-4D-S32-SP14	●	44	32	276	176	216	ST-SC0511	ST-WRT20		

SPID / T-DRILL

5xD SP □□

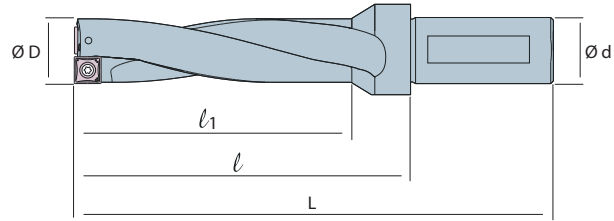



SP	DESCRIPTION 형번		STOCK 재고	DIMENSIONS 치수								
	SPID	형번		ØD	Ød	L	l	l ₁				
SPMG0502	SPID	130-5D-S20-SP05	●	13	20	135	65	85	ST-SC0206	ST-WRT06		
		140-5D-S20-SP05	●	14	20	140	70	90	ST-SC0206	ST-WRT06		
		150-5D-S20-SP05	●	15	20	145	75	95	ST-SC0206	ST-WRT06		
SPMG0602	SPID	160-5D-S25-SP06	●	16	25	156	80	100	ST-SC0226	ST-WRT07		
		170-5D-S25-SP06	●	17	25	161	85	105	ST-SC0226	ST-WRT07		
		180-5D-S25-SP06	●	18	25	167	90	111	ST-SC0226	ST-WRT07		
		190-5D-S25-SP06	●	19	25	172	95	116	ST-SC0226	ST-WRT07		
		200-5D-S25-SP06	●	20	25	179	100	123	ST-SC0226	ST-WRT07		
		210-5D-S25-SP06	●	21	25	184	105	128	ST-SC0226	ST-WRT07		
SPMG07T3	SPID	220-5D-S25-SP07	●	22	25	189	110	133	ST-SC0257	ST-WRT08		
		230-5D-S25-SP07	●	23	25	193	115	137	ST-SC0257	ST-WRT08		
		240-5D-S25-SP07	●	24	25	198	120	142	ST-SC0257	ST-WRT08		
		250-5D-S25-SP07	●	25	25	203	125	147	ST-SC0257	ST-WRT08		
		260-5D-S25-SP07	●	26	25	207	130	151	ST-SC0257	ST-WRT08		
		270-5D-S25-SP07	●	27	25	212	135	156	ST-SC0257	ST-WRT08		
SPMG0904	SPID	280-5D-S25-SP09	●	28	25	218	140	162	ST-SC3511	ST-WRT15		
		290-5D-S25-SP09	●	29	25	222	145	166	ST-SC3511	ST-WRT15		
		300-5D-S32-SP09	●	30	32	227	150	171	ST-SC3511	ST-WRT15		
		310-5D-S32-SP09		31	32	245	155	185	ST-SC3511	ST-WRT15		
		320-5D-S32-SP09		32	32	250	160	190	ST-SC3511	ST-WRT15		
		330-5D-S32-SP09		33	32	255	165	195	ST-SC3511	ST-WRT15		
SPMG1104	SPID	340-5D-S32-SP11		34	32	260	170	200	ST-SC0411	ST-WRT15		
		350-5D-S32-SP11		35	32	265	175	205	ST-SC0411	ST-WRT15		
		360-5D-S32-SP11		36	32	270	180	210	ST-SC0411	ST-WRT15		
		370-5D-S32-SP11		37	32	275	185	215	ST-SC0411	ST-WRT15		
		380-5D-S32-SP11		38	32	280	190	220	ST-SC0411	ST-WRT15		
		390-5D-S32-SP11		39	32	285	195	225	ST-SC0411	ST-WRT15		
		400-5D-S32-SP11		40	32	290	200	230	ST-SC0411	ST-WRT15		

WUD / U-DRILL

2xD

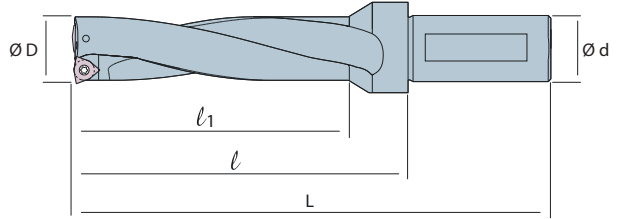
WC□□



WC	DESCRIPTION 형번		STOCK 재고	DIMENSIONS 치수					 ← 			
	WUD			ØD	Ød	L	l	l ₁				
WCGX030208	WUD	160-2D-S25-WC03	●	16	25	108	32	52	ST-SC0257	ST-WRT08		
		165-2D-S25-WC03	●	16.5	25	110	33	54	ST-SC0257	ST-WRT08		
		170-2D-S25-WC03	●	17	25	110	34	54	ST-SC0257	ST-WRT08		
		175-2D-S25-WC03	●	17.5	25	113	35	57	ST-SC0257	ST-WRT08		
		180-2D-S25-WC03	●	18	25	113	36	57	ST-SC0257	ST-WRT08		
		185-2D-S25-WC03	●	18.5	25	115	37	59	ST-SC0257	ST-WRT08		
		190-2D-S25-WC03	●	19	25	115	38	59	ST-SC0257	ST-WRT08		
		195-2D-S25-WC03	●	19.5	25	119	39	63	ST-SC0257	ST-WRT08		
WCGX040208	WUD	200-2D-S25-WC04	●	20	25	119	40	63	ST-SC0257	ST-WRT08		
		205-2D-S25-WC04	●	20.5	25	121	41	65	ST-SC0257	ST-WRT08		
		210-2D-S25-WC04	●	21	25	121	42	65	ST-SC0257	ST-WRT08		
		215-2D-S25-WC04	●	21.5	25	123	43	67	ST-SC0257	ST-WRT08		
		220-2D-S25-WC04	●	22	25	123	44	67	ST-SC0257	ST-WRT08		
		225-2D-S25-WC04	●	22.5	25	127	45	71	ST-SC0257	ST-WRT08		
		230-2D-S25-WC04	●	23	25	127	46	71	ST-SC0257	ST-WRT08		
		235-2D-S25-WC04	●	23.5	25	130	47	74	ST-SC0257	ST-WRT08		
WCGX050308	WUD	240-2D-S25-WC05	●	24	25	130	48	74	ST-SC0309	ST-WRT15		
		245-2D-S25-WC05	●	24.5	25	133	49	77	ST-SC0309	ST-WRT15		
		250-2D-S25-WC05	●	25	25	133	50	77	ST-SC0309	ST-WRT15		
		255-2D-S25-WC05	●	25.5	25	135	51	79	ST-SC0309	ST-WRT15		
		260-2D-S25-WC05	●	26	25	135	52	79	ST-SC0309	ST-WRT15		
		265-2D-S25-WC05	●	26.5	25	137	53	81	ST-SC0309	ST-WRT15		
		270-2D-S25-WC05	●	27	25	137	54	81	ST-SC0309	ST-WRT15		
		275-2D-S25-WC05	●	27.5	25	140	55	84	ST-SC0309	ST-WRT15		
		280-2D-S25-WC05	●	28	25	140	56	84	ST-SC0309	ST-WRT15		
		285-2D-S25-WC05	●	28.5	25	142	57	86	ST-SC0309	ST-WRT15		
		290-2D-S25-WC05	●	29	25	142	58	86	ST-SC0309	ST-WRT15		
		295-2D-S25-WC05	●	29.5	25	151	59	91	ST-SC0309	ST-WRT15		
WCGX06T308	WUD	300-2D-S32-WC06	●	30	32	151	60	91	ST-SC3511	ST-WRT15		
		310-2D-S32-WC06	●	31	32	154	62	94	ST-SC3511	ST-WRT15		

- TURNING
- GROOVING
- THREADING
- MILLING
- DRILLING
- ENDMILLS
- DRILLS
- SPARE PARTS
- INDEX

WUD / U-DRILL

2xD WC□□

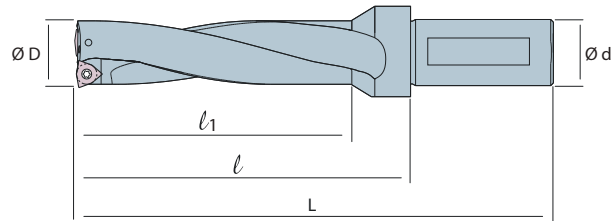

WC	DESCRIPTION 형번	STOCK 재고	DIMENSIONS 치수								
			ØD	Ød	L	l	l ₁				
WCGX06T308	WUD 320-2D-S32-WC06	●	32	32	156	64	96	ST-SC3511	ST-WRT15		
	330-2D-S32-WC06	●	33	32	159	66	99	ST-SC3511	ST-WRT15		
	340-2D-S32-WC06	●	34	32	161	68	101	ST-SC3511	ST-WRT15		
	350-2D-S32-WC06	●	35	32	164	70	104	ST-SC3511	ST-WRT15		
	360-2D-S32-WC06	●	36	32	167	72	107	ST-SC3511	ST-WRT15		
	370-2D-S32-WC06	●	37	32	170	74	110	ST-SC3511	ST-WRT15		
	380-2D-S32-WC06	●	38	32	173	76	113	ST-SC0411	ST-WRT15		
	390-2D-S32-WC06	●	39	32	175	78	115	ST-SC3511	ST-WRT15		
	400-2D-S32-WC06	●	40	32	178	80	118	ST-SC3511	ST-WRT15		
	410-2D-S32-WC06	●	41	32	181	82	121	ST-SC3511	ST-WRT15		
	420-2D-S32-WC06	●	42	32	183	84	123	ST-SC3511	ST-WRT15		
	420-2D-S32-WC06	●	43	32	186	86	126	ST-SC3511	ST-WRT15		
440-2D-S32-WC06	●	44	32	188	88	128	ST-SC3511	ST-WRT15			
WCGX080412	WUD 450-2D-S40-WC08	●	45	40	202	90	132	ST-SC0411	ST-WRT15		
	460-2D-S40-WC08	●	46	40	205	92	135	ST-SC0411	ST-WRT15		
	470-2D-S40-WC08	●	47	40	207	94	137	ST-SC0411	ST-WRT15		
	480-2D-S40-WC08	●	48	40	210	96	140	ST-SC0411	ST-WRT15		
	490-2D-S40-WC08	●	49	40	212	98	142	ST-SC0411	ST-WRT15		
	500-2D-S40-WC08	●	50	40	215	100	145	ST-SC0411	ST-WRT15		
	510-2D-S40-WC08	●	51	40	217	102	147	ST-SC0411	ST-WRT15		
	520-2D-S40-WC08	●	52	40	220	104	150	ST-SC0411	ST-WRT15		
	530-2D-S40-WC08	●	53	40	222	106	152	ST-SC0411	ST-WRT15		
	540-2D-S40-WC08	●	54	40	225	108	155	ST-SC0411	ST-WRT15		
	550-2D-S40-WC08	●	55	40	227	110	157	ST-SC0411	ST-WRT15		
	560-2D-S40-WC08	●	56	40	230	112	160	ST-SC0411	ST-WRT15		
	570-2D-S40-WC08	●	57	40	232	114	162	ST-SC0411	ST-WRT15		
	580-2D-S40-WC08	●	58	40	235	116	165	ST-SC0411	ST-WRT15		
590-2D-S40-WC08	●	59	40	237	118	167	ST-SC0411	ST-WRT15			
600-2D-S40-WC08	●	60	40	240	120	170	ST-SC0411	ST-WRT15			

WUD / U-DRILL

3xD

WC□□

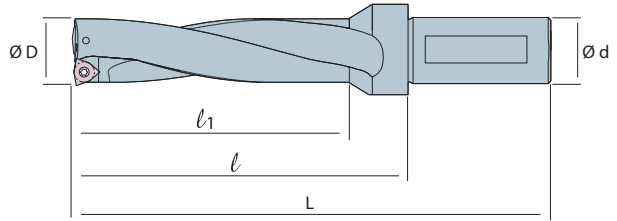

WC	DESCRIPTION 형번	STOCK 재고	DIMENSIONS 치수									
			ØD	Ød	L	l	l ₁					
WCGX030208	WUD	160-3D-S25-WC03	●	16	25	108	32	68	ST-SC0257	ST-WRT08		
		165-3D-S25-WC03	●	16.5	25	110	33	71	ST-SC0257	ST-WRT08		
		170-3D-S25-WC03	●	17	25	110	34	71	ST-SC0257	ST-WRT08		
		175-3D-S25-WC03	●	17.5	25	113	35	75	ST-SC0257	ST-WRT08		
		180-3D-S25-WC03	●	18	25	113	36	75	ST-SC0257	ST-WRT08		
		185-3D-S25-WC03	●	18.5	25	115	37	78	ST-SC0257	ST-WRT08		
		190-3D-S25-WC03	●	19	25	115	38	78	ST-SC0257	ST-WRT08		
		195-3D-S25-WC03	●	19.5	25	119	39	83	ST-SC0257	ST-WRT08		
WCGX040208	WUD	200-3D-S25-WC04	●	20	25	119	40	83	ST-SC0257	ST-WRT08		
		205-3D-S25-WC04	●	20.5	25	121	41	86	ST-SC0257	ST-WRT08		
		210-3D-S25-WC04	●	21	25	121	42	86	ST-SC0257	ST-WRT08		
		215-3D-S25-WC04	●	21.5	25	123	43	89	ST-SC0257	ST-WRT08		
		220-3D-S25-WC04	●	22	25	123	44	89	ST-SC0257	ST-WRT08		
		225-3D-S25-WC04	●	22.5	25	127	45	94	ST-SC0257	ST-WRT08		
		230-3D-S25-WC04	●	23	25	127	46	94	ST-SC0257	ST-WRT08		
		235-3D-S25-WC04	●	23.5	25	130	47	98	ST-SC0309	ST-WRT15		
WCGX050308	WUD	240-3D-S25-WC05	●	24	25	130	48	98	ST-SC0309	ST-WRT15		
		245-3D-S25-WC05	●	24.5	25	133	49	102	ST-SC0309	ST-WRT15		
		250-3D-S25-WC05	●	25	25	133	50	102	ST-SC0309	ST-WRT15		
		255-3D-S25-WC05	●	25.5	25	135	51	105	ST-SC0309	ST-WRT15		
		260-3D-S25-WC05	●	26	25	135	52	105	ST-SC0309	ST-WRT15		
		265-3D-S25-WC05	●	26.5	25	137	79.5	108	ST-SC0309	ST-WRT15		
		270-3D-S25-WC05	●	27	25	137	81	108	ST-SC0309	ST-WRT15		
		275-3D-S25-WC05	●	27.5	25	140	82.5	112	ST-SC0309	ST-WRT15		
		280-3D-S25-WC05	●	28	25	140	84	112	ST-SC0309	ST-WRT15		
		285-3D-S25-WC05	●	28.5	25	142	85.5	115	ST-SC0309	ST-WRT15		
		290-3D-S25-WC05	●	29	25	142	87	115	ST-SC0309	ST-WRT15		
	295-3D-S25-WC05	●	29.5	25	151	88.5	121	ST-SC3511	ST-WRT08			
WCGX06T308	WUD	300-3D-S32-WC06	●	30	32	151	90	121	ST-SC3511	ST-WRT15		

- TURNING
- GROOVING
- THREADING
- MILLING
- DRILLING
- ENDMILLS
- DRILLS
- SPARE PARTS
- INDEX

WUD / U-DRILL

3xD WC□□

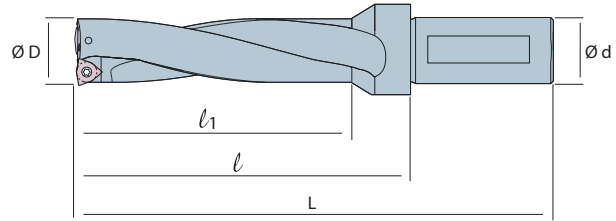



WC	DESCRIPTION 형번		STOCK 재고	DIMENSIONS 치수						
				ØD	Ød	L	l	l ₁		
WCGX06T308	WUD	310-3D-S32-WC06	●	31	32	154	93	125	ST-SC3511	ST-WRT15
		320-3D-S32-WC06	●	32	32	156	96	128	ST-SC3511	ST-WRT15
		330-3D-S32-WC06	●	33	32	159	99	132	ST-SC3511	ST-WRT15
		340-3D-S32-WC06	●	34	32	161	102	135	ST-SC3511	ST-WRT15
		350-3D-S32-WC06	●	35	32	164	105	139	ST-SC3511	ST-WRT15
		360-3D-S32-WC06	●	36	32	167	108	143	ST-SC3511	ST-WRT15
		370-3D-S32-WC06	●	37	32	170	111	147	ST-SC3511	ST-WRT15
		380-3D-S32-WC06	●	38	32	173	114	151	ST-SC0411	ST-WRT15
		390-3D-S32-WC06	●	39	32	175	117	154	ST-SC3511	ST-WRT15
		400-3D-S32-WC06	●	40	32	178	120	158	ST-SC3511	ST-WRT15
		410-3D-S32-WC06	●	41	32	181	123	162	ST-SC3511	ST-WRT15
		420-3D-S32-WC06	●	42	32	183	126	165	ST-SC3511	ST-WRT15
		430-3D-S32-WC06	●	43	32	186	129	169	ST-SC3511	ST-WRT15
	440-3D-S32-WC06	●	44	32	188	132	172	ST-SC3511	ST-WRT15	
WCGX080412	WUD	450-3D-S40-WC08	●	45	40	202	135	177	ST-SC0411	ST-WRT15
		460-3D-S40-WC08	●	46	40	205	138	181	ST-SC0411	ST-WRT15
		470-3D-S40-WC08	●	47	40	207	141	184	ST-SC0411	ST-WRT15
		480-3D-S40-WC08	●	48	40	210	144	188	ST-SC0411	ST-WRT15
		490-3D-S40-WC08	●	49	40	212	147	191	ST-SC0411	ST-WRT15
		500-3D-S40-WC08	●	50	40	215	150	195	ST-SC0411	ST-WRT15
		510-3D-S40-WC08	●	51	40	217	153	198	ST-SC0411	ST-WRT15
		520-3D-S40-WC08	●	52	40	220	156	201	ST-SC0411	ST-WRT15
		530-3D-S40-WC08	●	53	40	222	159	204	ST-SC0411	ST-WRT15
		540-3D-S40-WC08	●	54	40	225	162	207	ST-SC0411	ST-WRT15
		550-3D-S40-WC08	●	55	40	227	165	210	ST-SC0411	ST-WRT15
		560-3D-S40-WC08	●	56	40	230	168	213	ST-SC0411	ST-WRT15
		570-3D-S40-WC08	●	57	40	232	171	216	ST-SC0411	ST-WRT15
	580-3D-S40-WC08	●	58	40	235	174	219	ST-SC0411	ST-WRT15	
	590-3D-S40-WC08	●	59	40	237	177	222	ST-SC0411	ST-WRT15	
	600-3D-S40-WC08	●	60	40	240	180	225	ST-SC0411	ST-WRT15	

WUD / U-DRILL

4xD

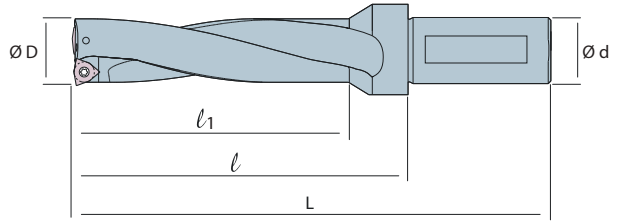
WC□□



WC	DESCRIPTION 형번	STOCK 재고	DIMENSIONS 치수					 ← 			
			ØD	Ød	L	l	l ₁				
WCGX030208	WUD	160-4D-S25-WC03	●	16	25	140	64	84	ST-SC0257	ST-WRT08	
		165-4D-S25-WC03	●	16.5	25	140	64	84	ST-SC0257	ST-WRT08	
		170-4D-S25-WC03	●	17	25	144	68	88	ST-SC0257	ST-WRT08	
		175-4D-S25-WC03	●	17.5	25	144	68	88	ST-SC0257	ST-WRT08	
		180-4D-S25-WC03	●	18	25	149	72	92	ST-SC0257	ST-WRT08	
		185-4D-S25-WC03	●	18.5	25	149	72	92	ST-SC0257	ST-WRT08	
		190-4D-S25-WC03	●	19	25	153	76	97	ST-SC0257	ST-WRT08	
		195-4D-S25-WC03	●	19.5	25	153	76	97	ST-SC0257	ST-WRT08	
WCGX040208	WUD	200-4D-S25-WC04	●	20	25	159	80	103	ST-SC0257	ST-WRT08	
		205-4D-S25-WC04	●	20.5	25	159	80	103	ST-SC0257	ST-WRT08	
		210-4D-S25-WC04	●	21	25	163	84	107	ST-SC0257	ST-WRT08	
		215-4D-S25-WC04	●	21.5	25	163	84	107	ST-SC0257	ST-WRT08	
		220-4D-S25-WC04	●	22	25	167	88	111	ST-SC0257	ST-WRT08	
		225-4D-S25-WC04	●	22.5	25	167	88	111	ST-SC0257	ST-WRT08	
		230-4D-S25-WC04	●	23	25	173	92	117	ST-SC0257	ST-WRT08	
		235-4D-S25-WC04	●	23.5	25	173	92	117	ST-SC0309	ST-WRT08	
WCGX050308	WUD	240-4D-S25-WC05	●	24	25	178	96	122	ST-SC0309	ST-WRT08	
		245-4D-S25-WC05	●	24.5	25	178	96	122	ST-SC0309	ST-WRT08	
		250-4D-S25-WC05	●	25	25	183	100	127	ST-SC0309	ST-WRT08	
		255-4D-S25-WC05	●	25.5	25	183	100	127	ST-SC0309	ST-WRT08	
		260-4D-S25-WC05	●	26	25	187	104	131	ST-SC0309	ST-WRT08	
		265-4D-S25-WC05	●	26.5	25	187	104	131	ST-SC0309	ST-WRT08	
		270-4D-S25-WC05	●	27	25	191	108	135	ST-SC0309	ST-WRT08	
		275-4D-S25-WC05	●	27.5	25	191	108	135	ST-SC0309	ST-WRT08	
		280-4D-S25-WC05	●	28	25	196	112	140	ST-SC0309	ST-WRT08	
		285-4D-S25-WC05	●	28.5	25	196	112	140	ST-SC0309	ST-WRT08	
		290-4D-S25-WC05	●	29	25	200	116	144	ST-SC0309	ST-WRT08	
	295-4D-S25-WC05	●	29.5	25	200	116	144	ST-SC0309	ST-WRT08		

- TURNING
- GROOVING
- THREADING
- MILLING
- DRILLING
- ENDMILLS
- DRILLS
- SPARE PARTS
- INDEX

WUD / U-DRILL

4xD WC□□

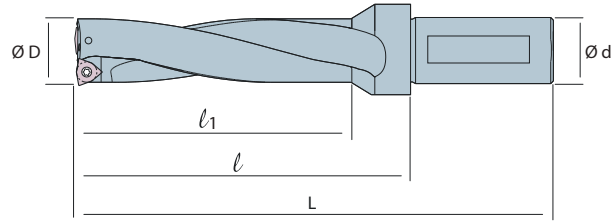

WC	DESCRIPTION 형번		STOCK 재고	DIMENSIONS 치수								
	WUD			ØD	Ød	L	l	l ₁				
WCGX06T308		300-4D-S32-WC06	●	30	32	211	120	151	ST-SC3511	ST-WRT15		
		310-4D-S32-WC06	●	31	32	216	124	156	ST-SC3511	ST-WRT15		
		320-4D-S32-WC06	●	32	32	220	128	160	ST-SC3511	ST-WRT15		
		330-4D-S32-WC06	●	33	32	225	132	165	ST-SC3511	ST-WRT15		
		335-4D-S32-WC06	●	33.5	32	227	134	167	ST-SC3511	ST-WRT15		
		340-4D-S32-WC06	●	34	32	229	136	169	ST-SC3511	ST-WRT15		
		350-4D-S32-WC06	●	35	32	234	140	174	ST-SC3511	ST-WRT15		
		360-4D-S32-WC06	●	36	32	239	144	179	ST-SC3511	ST-WRT15		
		370-4D-S32-WC06	●	37	32	244	148	184	ST-SC3511	ST-WRT15		
		380-4D-S32-WC06	●	38	32	251	152	189	ST-SC3511	ST-WRT15		
		385-4D-S32-WC06	●	38.5	32	253	154	191	ST-SC3511	ST-WRT15		
		390-4D-S32-WC06	●	39	32	258	156	193	ST-SC3511	ST-WRT15		
		400-4D-S32-WC06	●	40	32	263	160	198	ST-SC3511	ST-WRT15		
	410-4D-S32-WC06	●	41	32	267	164	203	ST-SC3511	ST-WRT15			
WCGX080412	WUD	420-4D-S32-WC08	●	42	32	272	168	207	ST-SC3511	ST-WRT15		
		430-4D-S32-WC08	●	43	32	276	172	212	ST-SC3511	ST-WRT15		
		440-4D-S32-WC08	●	44	32	292	176	216	ST-SC0411	ST-WRT15		
		450-4D-S32-WC08	●	45	32	297	180	222	ST-SC0411	ST-WRT20		
		460-4D-S32-WC08	●	46	32	301	184	227	ST-SC0411	ST-WRT20		
		470-4D-S32-WC08	●	47	32	306	188	231	ST-SC0411	ST-WRT20		
		480-4D-S32-WC08	●	48	32	310	192	236	ST-SC0411	ST-WRT20		
		490-4D-S32-WC08	●	49	32	315	196	240	ST-SC0411	ST-WRT20		
	500-4D-S32-WC08	●	50	32	310	200	245	ST-SC0411	ST-WRT20			

WUD / U-DRILL

5xD

WC□□

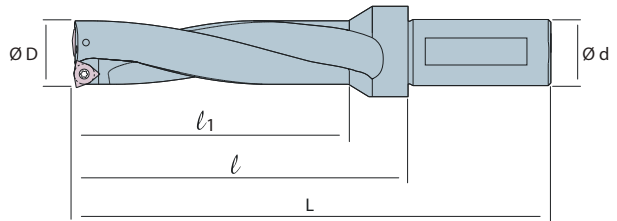

WC	DESCRIPTION 형번		STOCK 재고	DIMENSIONS 치수								
				ØD	Ød	L	l	l ₁				
WCGX030208	WUD	160-5D-S25-WC03	●	16	25	156	80	100	ST-SC0257	ST-WRT08		
		170-5D-S25-WC03	●	17	25	161	85	105	ST-SC0257	ST-WRT08		
		180-5D-S25-WC03	●	18	25	167	90	111	ST-SC0257	ST-WRT08		
		190-5D-S25-WC03	●	19	25	172	95	116	ST-SC0257	ST-WRT08		
WCGX040208	WUD	200-5D-S25-WC04	●	20	25	179	100	123	ST-SC0257	ST-WRT08		
		210-5D-S25-WC04	●	21	25	184	105	128	ST-SC0257	ST-WRT08		
		220-5D-S25-WC04	●	22	25	189	110	133	ST-SC0257	ST-WRT08		
		230-5D-S25-WC04	●	23	25	193	115	137	ST-SC0257	ST-WRT08		
WCGX050308	WUD	240-5D-S25-WC05	●	24	25	198	120	142	ST-SC0309	ST-WRT08		
		250-5D-S25-WC05	●	25	25	203	125	147	ST-SC0309	ST-WRT08		
		260-5D-S25-WC05	●	26	25	207	130	151	ST-SC0309	ST-WRT08		
		270-5D-S25-WC05	●	27	25	212	135	156	ST-SC0309	ST-WRT08		
		280-5D-S25-WC05	●	28	25	218	140	162	ST-SC0309	ST-WRT08		
		290-5D-S25-WC05	●	29	25	222	145	166	ST-SC0309	ST-WRT08		
WCGX06T308	WUD	300-5D-S32-WC06		30	32	227	150	171	ST-SC3511	ST-WRT15		
		310-5D-S32-WC06		31	32	245	155	185	ST-SC3511	ST-WRT15		
		320-5D-S32-WC06		32	32	250	160	190	ST-SC3511	ST-WRT15		
		330-5D-S32-WC06		33	32	255	165	195	ST-SC3511	ST-WRT15		
		340-5D-S32-WC06		34	32	260	170	200	ST-SC3511	ST-WRT15		
		350-5D-S32-WC06		35	32	265	175	205	ST-SC3511	ST-WRT15		
		360-5D-S32-WC06		36	32	270	180	210	ST-SC3511	ST-WRT15		
		370-5D-S32-WC06		37	32	275	185	215	ST-SC3511	ST-WRT15		
		380-5D-S32-WC06		38	32	280	190	220	ST-SC3511	ST-WRT15		
		390-5D-S32-WC06		39	32	285	195	225	ST-SC3511	ST-WRT15		
	400-5D-S32-WC06		40	32	290	200	230	ST-SC3511	ST-WRT15			

TURNING

GROOVING

THREADING

MILLING

DRILLING

ENDMILLS

DRILLS

SPARE PARTS

INDEX

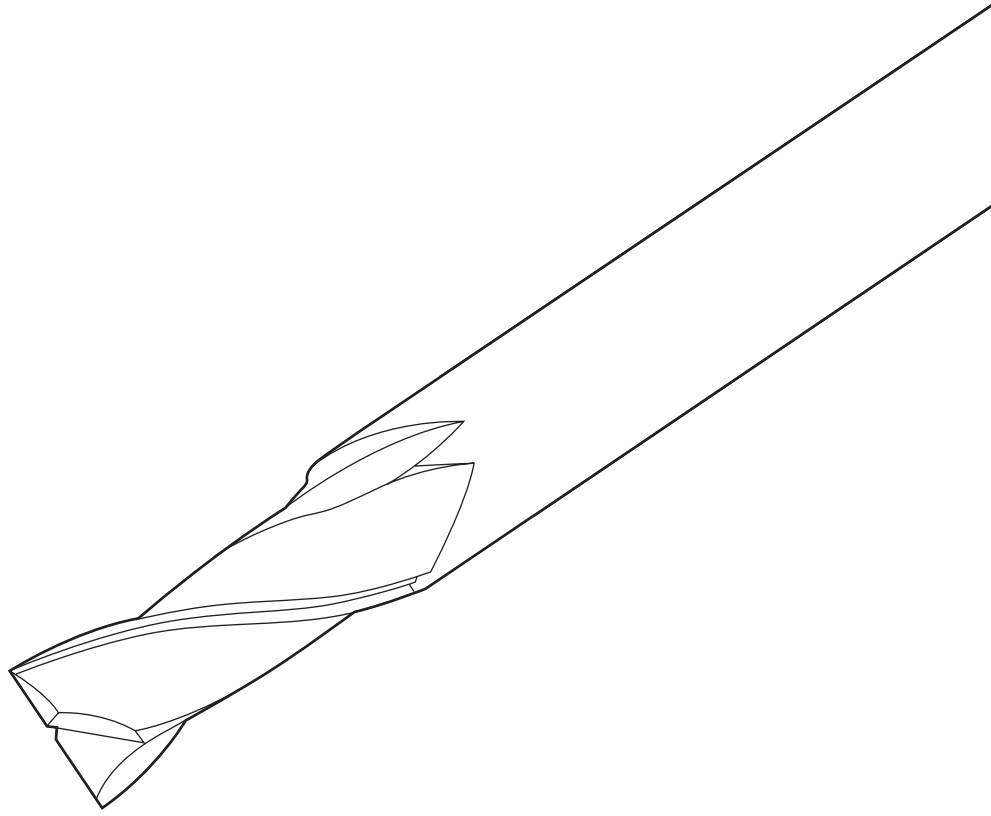

ENDMILLS/ 엔드밀







carbide 초경 /297

ENDMILLS / carbide
엔드밀 / 초경

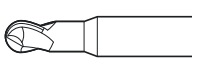
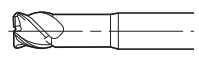
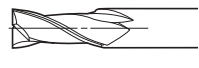

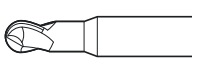
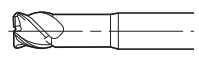
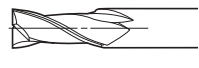
- 타입
- 그루브
- 나사
- 미립
- 인테셔널 드릴
- 엔드밀
- 슬리드 드릴
- 부품
- 색인표

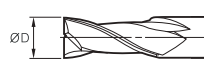
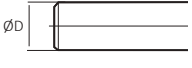
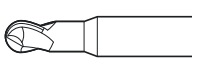
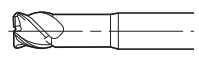
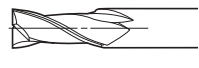
R	D6	d6	I20	L75
1	2	3	4	5

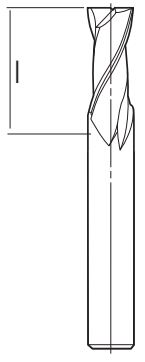
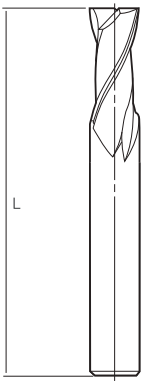
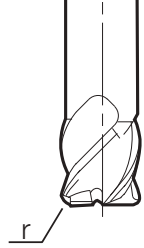
<p>1 Type (타입)</p> <table border="1" style="width: 100%; border-collapse: collapse;"> <tr> <td style="width: 15%;">B (볼)</td> <td></td> </tr> <tr> <td>R (레디우스)</td> <td></td> </tr> <tr> <td>S (플랫)</td> <td></td> </tr> <tr> <td>ALU (비철금속용)</td> <td></td> </tr> </table>	B (볼)		R (레디우스)		S (플랫)		ALU (비철금속용)		<p>2 Cutting Dia. (가공경)</p> <div style="text-align: center;">  </div>	<p>3 Shaft Dia. (샹크경)</p> <div style="text-align: center;">  </div>
B (볼)										
R (레디우스)										
S (플랫)										
ALU (비철금속용)										
<p>4 Flute Length(mm) (플루트길이)</p> <div style="text-align: center;">  </div>	<p>5 Overall Length(mm) (전장)</p> <div style="text-align: center;">  </div>	<p>6 Radius (레디우스)</p> <div style="text-align: center;">  </div>								



7	No. of flute (플루트 수)
2	
3	
4	
6	

8	Application (재종)
H45	General HRC45 (범용)
H55	Hardened HRC55 (금형강용)
H68	Free hardened HRC68 (열처리된 고경도강)

Endmill Grades / 재종

MATERIAL (ISO범위)	GRADE (재종)	Color (색깔)	Operation (적용)
P/M/K	H45 (범용)	DARK GRAY (짙은 회색)	General milling for steel up to 45HRc 범용 HRc 45 이하
			Ultra fine substrate, PVD coating 초미립소재, TiAlN PVD코팅
	H55 (금형강용)	COPPER (구리)	High cutting on hardened steel up to 55HRc 금형강용 HRc 55 이하
			Ultra fine substrate, PVD coating 초미립소재, TiSiN PVD 코팅
	H68 (고경도강)	DARK BLUE (짙은 파랑)	High cutting on hardened steel up to 68HRc 고경도강용 HRc 68 이하
			Ultra fine substrate, PVD coating 초미립소재, nACo PVD 코팅
N	Non Coated H55 (비철금속용)	Silver (은색)	General milling for aluminum and brass 비철금속용 (알루미늄, 구리외)
			Ultra fine substrate, Uncoated 초미립 초경 소재

- TURNING
- GROOVING
- THREADING
- MILLING
- DRILLING
- ENDMILLS
- DRILLS
- SPARE PARTS
- INDEX

터닝

그라인딩

나사

밀링

인테리블 드릴

엔드밀

솔리드 드릴

부품

색인표

Square (플랫 타입)

UP TO HRC45 (HRC 45이하)

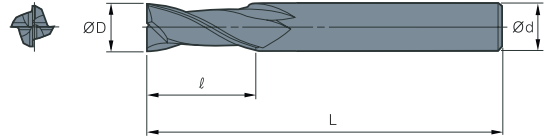

	DESCRIPTION 형번	STOCK 재고	DIMENSIONS 치수				
			ØD	Ød	l	L	r
	S-D1xd4xl3xL50xZ4 H45	●	1	4	3	50	-
	S-D1xd6xl3xL50xZ4 H45	●	1	6	3	50	-
	S-D1,5xd4xl4xL50xZ4 H45	●	1,5	4	4	50	-
	S-D1,5xd6xl4xL50xZ4 H45	●	1,5	6	4	50	-
	S-D2xd4xl6xL50xZ4 H45	●	2	4	6	50	-
	S-D2xd6xl6xL50xZ4 H45	●	2	6	6	50	-
	S-D2,5xd4xl8xL50xZ4 H45	●	2,5	4	8	50	-
	S-D2,5xd6xl8xL50xZ4 H45	●	2,5	6	8	50	-
	S-D3xd3xl8xL50xZ4 H45	●	3	3	8	50	-
	S-D3xd4xl8xL50xZ4 H45	●	3	4	8	50	-
	S-D3xd6xl8xL50xZ4 H45	●	3	6	8	50	-
	S-D3,5xd4xl11xL50xZ4 H45	●	3,5	4	11	50	-
	S-D3,5xd6xl11xL50xZ4 H45	●	3,5	6	11	50	-
	S-D4xd4xl11xL50xZ4 H45	●	4	4	11	50	-
	S-D4xd6xl11xL50xZ4 H45	●	4	6	11	50	-
	S-D4xd4xl20xL75xZ4 H45	●	4	4	20	75	-
	S-D4xd4xl20xL100xZ4 H45	●	4	4	20	100	-
	S-D5xd5xl13xL50xZ4 H45	●	5	5	13	50	-
	S-D5xd6xl13xL50xZ4 H45	●	5	6	13	50	-
	S-D5xd5xl20xL75xZ4 H45	●	5	5	20	75	-
	S-D5xd5xl20xL100xZ4 H45	●	5	5	20	100	-
	S-D6xd6xl15xL50xZ4 H45	●	6	6	15	50	-
	S-D6xd6xl20xL75xZ4 H45	●	6	6	20	75	-

Square (플랫 타입)

UP TO HRC45 (HRc 45이하)

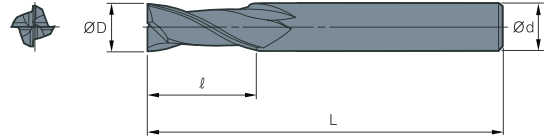

	DESCRIPTION 형번	STOCK 재고	DIMENSIONS 치수				
			ØD	Ød	l	L	r
	S-D6xd6xl25xL100xZ4 H45	●	6	6	25	100	-
	S-D6xd6xl40xL150xZ4 H45	●	6	6	40	150	-
	S-D7xd8xl20xL60xZ4 H45	●	7	8	20	60	-
	S-D8xd8xl20xL60xZ4 H45	●	8	8	20	60	-
	S-D8xd8xl25xL75xZ4 H45	●	8	8	25	75	-
	S-D8xd8xl40xL100xZ4 H45	●	8	8	40	100	-
	S-D8xd8xl40xL150xZ4 H45	●	8	8	40	150	-
	S-D9xd10xl25xL75xZ4 H45	●	9	10	25	75	-
	S-D10xd10xl25xL75xZ4 H45	●	10	10	25	75	-
	S-D10xd10xl40xL100xZ4 H45	●	10	10	40	100	-
	S-D10xd10xl50xL150xZ4 H45	●	10	10	50	150	-
	S-D12xd12xl30xL75xZ4 H45	●	12	12	30	75	-
	S-D12xd12xl45xL100xZ4 H45	●	12	12	45	100	-
	S-D12xd12xl50xL150xZ4 H45	●	12	12	50	150	-
	S-D14xd14xl40xL80xZ4 H45	●	14	14	40	80	-
	S-D14xd14xl50xL100xZ4 H45	●	14	14	50	100	-
	S-D14xd14xl50xL150xZ4 H45	●	14	14	50	150	-
	S-D16xd16xl45xL100xZ4 H45	●	16	16	45	100	-
	S-D16xd16xl50xL150xZ4 H45	●	16	16	50	150	-
	S-D18xd18xl45xL100xZ4 H45	●	18	18	45	100	-
	S-D18xd18xl50xL150xZ4 H45	●	18	18	50	150	-
	S-D20xd20xl45xL100xZ4 H45	●	20	20	45	100	-
	S-D20xd20xl75xL150xZ4 H45	●	20	20	75	150	-

TURNING

GROOVING

THREADING

MILLING

DRILLING

ENDMILLS

DRILLS

SPARE PARTS

INDEX

터닝

Square (플랫 타입)

UP TO HRC55 (HRc 55이하)

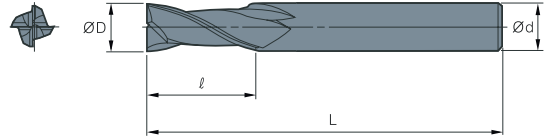

그라인딩

나사

밀링

인테이크 드릴

엔드밀

솔리드 드릴

부품

색인표



DESCRIPTION 형번

STOCK 재고

DIMENSIONS 치수

ØD

Ød

l

L

r

S-D1xd4xl3xL50xZ4 H55	●	1	4	3	50	-
S-D1xd6xl3xL50xZ4 H55	●	1	6	3	50	-
S-D1,5xd4xl4xL50xZ4 H55	●	1,5	4	4	50	-
S-D1,5xd6xl4xL50xZ4 H55	●	1,5	6	4	50	-
S-D2xd4xl6xL50xZ4 H55	●	2	4	6	50	-
S-D2xd6xl6xL50xZ4 H55	●	2	6	6	50	-
S-D2,5xd4xl8xL50xZ4 H55	●	2,5	4	8	50	-
S-D2,5xd6xl8xL50xZ4 H55	●	2,5	6	8	50	-
S-D3xd3xl8xL50xZ4 H55	●	3	3	8	50	-
S-D3xd4xl8xL50xZ4 H55	●	3	4	8	50	-
S-D3xd6xl8xL50xZ4 H55	●	3	6	8	50	-
S-D3,5xd4xl11xL50xZ4 H55	●	3,5	4	11	50	-
S-D3,5xd6xl11xL50xZ4 H55	●	3,5	6	11	50	-
S-D4xd4xl11xL50xZ4 H55	●	4	4	11	50	-
S-D4xd6xl11xL50xZ4 H55	●	4	6	11	50	-
S-D4xd4xl20xL75xZ4 H55	●	4	4	20	75	-
S-D4xd4xl20xL100xZ4 H55	●	4	4	20	100	-
S-D5xd5xl13xL50xZ4 H55	●	5	5	13	50	-
S-D5xd6xl13xL50xZ4 H55	●	5	6	13	50	-
S-D5xd5xl20xL75xZ4 H55	●	5	5	20	75	-
S-D5xd5xl20xL100xZ4 H55	●	5	5	20	100	-
S-D6xd6xl15xL50xZ4 H55	●	6	6	15	50	-
S-D6xd6xl20xL75xZ4 H55	●	6	6	20	75	-

Square (플랫 타입)

UP TO HRC55 (HRc 55이하)

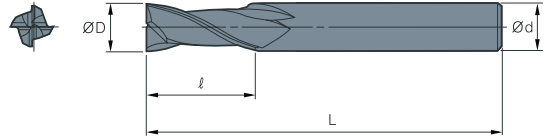

	DESCRIPTION 형번	STOCK 재고	DIMENSIONS 치수				
			ØD	Ød	l	L	r
	S-D6xd6xl25xL100xZ4 H55	●	6	6	25	100	-
	S-D6xd6xl40xL150xZ4 H55	●	6	6	40	150	-
	S-D7xd8xl20xL60xZ4 H55	●	7	8	20	60	-
	S-D8xd8xl20xL60xZ4 H55	●	8	8	20	60	-
	S-D8xd8xl25xL75xZ4 H55	●	8	8	25	75	-
	S-D8xd8xl40xL100xZ4 H55	●	8	8	40	100	-
	S-D8xd8xl40xL150xZ4 H55	●	8	8	40	150	-
	S-D9xd10xl25xL75xZ4 H55	●	9	10	25	75	-
	S-D10xd10xl25xL75xZ4 H55	●	10	10	25	75	-
	S-D10xd10xl40xL100xZ4 H55	●	10	10	40	100	-
	S-D10xd10xl50xL150xZ4 H55	●	10	10	50	150	-
	S-D12xd12xl30xL75xZ4 H55	●	12	12	30	75	-
	S-D12xd12xl45xL100xZ4 H55	●	12	12	45	100	-
	S-D12xd12xl50xL150xZ4 H55	●	12	12	50	150	-
	S-D14xd14xl40xL80xZ4 H55	●	14	14	40	80	-
	S-D14xd14xl50xL100xZ4 H55	●	14	14	50	100	-
	S-D14xd14xl50xL150xZ4 H55	●	14	14	50	150	-
	S-D16xd16xl45xL100xZ4 H55	●	16	16	45	100	-
	S-D16xd16xl50xL150xZ4 H55	●	16	16	50	150	-
	S-D18xd18xl45xL100xZ4 H55	●	18	18	45	100	-
	S-D18xd18xl50xL150xZ4 H55	●	18	18	50	150	-
	S-D20xd20xl45xL100xZ4 H55	●	20	20	45	100	-
	S-D20xd20xl75xL150xZ4 H55	●	20	20	75	150	-

TURNING

GROOVING

THREADING

MILLING

DRILLING

ENDMILLS

DRILLS

SPARE PARTS

INDEX

터닝

Square (플랫 타입)

UP TO HRC68 (HRC 68이하)

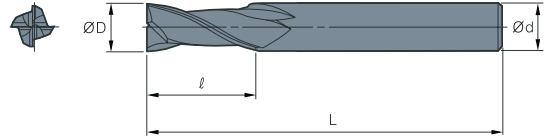

그라인드

나사

밀링

인테그럴 드릴

엔드밀

솔리드 드릴

부품

색인표



DESCRIPTION 형번	STOCK 재고	DIMENSIONS 치수				
		ØD	Ød	l	L	r
S-D1xd4xl3xL50xZ4 H68	●	1	4	3	50	-
S-D1xd6xl3xL50xZ4 H68	●	1	6	3	50	-
S-D1,5xd4xl4xL50xZ4 H68	●	1,5	4	4	50	-
S-D1,5xd6xl4xL50xZ4 H68	●	1,5	6	4	50	-
S-D2xd4xl6xL50xZ4 H68	●	2	4	6	50	-
S-D2xd6xl6xL50xZ4 H68	●	2	6	6	50	-
S-D2,5xd4xl8xL50xZ4 H68	●	2,5	4	8	50	-
S-D2,5xd6xl8xL50xZ4 H68	●	2,5	6	8	50	-
S-D3xd3xl8xL50xZ4 H68	●	3	3	8	50	-
S-D3xd4xl8xL50xZ4 H68	●	3	4	8	50	-
S-D3xd6xl8xL50xZ4 H68	●	3	6	8	50	-
S-D3,5xd4xl11xL50xZ4 H68	●	3,5	4	11	50	-
S-D3,5xd6xl11xL50xZ4 H68	●	3,5	6	11	50	-
S-D4xd4xl11xL50xZ4 H68	●	4	4	11	50	-
S-D4xd6xl11xL50xZ4 H68	●	4	6	11	50	-
S-D4xd4xl20xL75xZ4 H68	●	4	4	20	75	-
S-D4xd4xl20xL100xZ4 H68	●	4	4	20	100	-
S-D5xd5xl13xL50xZ4 H68	●	5	5	13	50	-
S-D5xd6xl13xL50xZ4 H68	●	5	6	13	50	-
S-D5xd5xl20xL75xZ4 H68	●	5	5	20	75	-
S-D5xd5xl20xL100xZ4 H68	●	5	5	20	100	-
S-D6xd6xl15xL50xZ4 H68	●	6	6	15	50	-
S-D6xd6xl20xL75xZ4 H68	●	6	6	20	75	-

Square (플랫 타입)

UP TO HRC68 (HRc 68이하)

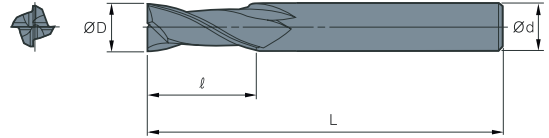

	DESCRIPTION 형번	STOCK 재고	DIMENSIONS 치수				
			ØD	Ød	l	L	r
	S-D6xd6xl25xL100xZ4 H68	●	6	6	25	100	-
	S-D6xd6xl40xL150xZ4 H68	●	6	6	40	150	-
	S-D7xd8xl20xL60xZ4 H68	●	7	8	20	60	-
	S-D8xd8xl20xL60xZ4 H68	●	8	8	20	60	-
	S-D8xd8xl25xL75xZ4 H68	●	8	8	25	75	-
	S-D8xd8xl40xL100xZ4 H68	●	8	8	40	100	-
	S-D8xd8xl40xL150xZ4 H68	●	8	8	40	150	-
	S-D9xd10xl25xL75xZ4 H68	●	9	10	25	75	-
	S-D10xd10xl25xL75xZ4 H68	●	10	10	25	75	-
	S-D10xd10xl40xL100xZ4 H68	●	10	10	40	100	-
	S-D10xd10xl50xL150xZ4 H68	●	10	10	50	150	-
	S-D12xd12xl30xL75xZ4 H68	●	12	12	30	75	-
	S-D12xd12xl45xL100xZ4 H68	●	12	12	45	100	-
	S-D12xd12xl50xL150xZ4 H68	●	12	12	50	150	-
	S-D14xd14xl40xL80xZ4 H68	●	14	14	40	80	-
	S-D14xd14xl50xL100xZ4 H68	●	14	14	50	100	-
	S-D14xd14xl50xL150xZ4 H68	●	14	14	50	150	-
	S-D16xd16xl45xL100xZ4 H68	●	16	16	45	100	-
	S-D16xd16xl50xL150xZ4 H68	●	16	16	50	150	-
	S-D18xd18xl45xL100xZ4 H68	●	18	18	45	100	-
	S-D18xd18xl50xL150xZ4 H68	●	18	18	50	150	-
	S-D20xd20xl45xL100xZ4 H68	●	20	20	45	100	-
	S-D20xd20xl75xL150xZ4 H68	●	20	20	75	150	-

TURNING

GROOVING

THREADING

MILLING

DRILLING

ENDMILLS

DRILLS

SPARE PARTS

INDEX

터닝

그라인딩

나사

밀링

인테리블 드릴

엔드밀

솔리드 드릴

부품

색인표

Ball (볼타입)

UP TO HRC45 (HRC 45이하)

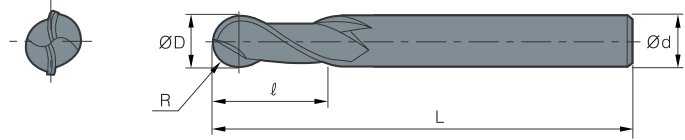

	DESCRIPTION 형번	STOCK 재고	DIMENSIONS 치수				
			ØD	Ød	l	L	r
	B-D1xd4xl3xL50xZ2 H45	●	1	4	3	50	-
	B-D1xd6xl3xL50xZ2 H45	●	1	6	3	50	-
	B-D1,5xd4xl4xL50xZ2 H45	●	1,5	4	4	50	-
	B-D1,5xd6xl4xL50xZ2 H45	●	1,5	6	4	50	-
	B-D2xd4xl6xL50xZ2 H45	●	2	4	6	50	-
	B-D2xd6xl6xL50xZ2 H45	●	2	6	6	50	-
	B-D2,5xd4xl8xL50xZ2 H45	●	2,5	4	8	50	-
	B-D2,5xd6xl8xL50xZ2 H45	●	2,5	6	8	50	-
	B-D3xd3xl8xL50xZ2 H45	●	3	3	8	50	-
	B-D3xd4xl8xL50xZ2 H45	●	3	4	8	50	-
	B-D3xd6xl8xL50xZ2 H45	●	3	6	8	50	-
	B-D3,5xd4xl11xL50xZ2 H45	●	3,5	4	11	50	-
	B-D3,5xd6xl11xL50xZ2 H45	●	3,5	6	11	50	-
	B-D4xd4xl11xL50xZ2 H45	●	4	4	11	50	-
	B-D4xd6xl11xL50xZ2 H45	●	4	6	11	50	-
	B-D4xd4xl20xL75xZ2 H45	●	4	4	20	75	-
	B-D4xd4xl20xL100xZ2 H45	●	4	4	20	100	-
	B-D5xd5xl13xL50xZ2 H45	●	5	5	13	50	-
	B-D5xd6xl13xL50xZ2 H45	●	5	6	13	50	-
	B-D5xd5xl20xL75xZ2 H45	●	5	5	20	75	-
	B-D5xd5xl20xL100xZ2 H45	●	5	5	20	100	-
	B-D6xd6xl15xL50xZ2 H45	●	6	6	15	50	-
	B-D6xd6xl20xL75xZ2 H45	●	6	6	20	75	-

ENDMILLS 엔드밀

Ball (볼타입)

UP TO HRC45 (HRc 45이하)

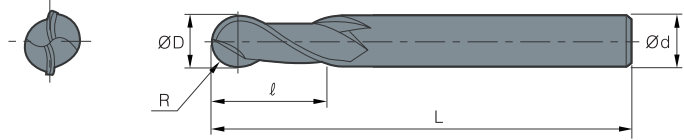

	DESCRIPTION 형번	STOCK 재고	DIMENSIONS 치수				
			ØD	Ød	l	L	r
	B-D6xd6x125xL100xZ2 H45	●	6	6	25	100	-
	B-D6xd6x140xL150xZ2 H45	●	6	6	40	150	-
	B-D7xd8x120xL60xZ2 H45	●	7	8	20	60	-
	B-D8xd8x120xL60xZ2 H45	●	8	8	20	60	-
	B-D8xd8x125xL75xZ2 H45	●	8	8	25	75	-
	B-D8xd8x140xL150xZ2 H45	●	8	8	40	150	-
	B-D9xd10x125xL75xZ2 H45	●	9	10	25	75	-
	B-D10xd10x125xL75xZ2 H45	●	10	10	25	75	-
	B-D10xd10x140xL100xZ2 H45	●	10	10	40	100	-
	B-D10xd10x150xL150xZ2 H45	●	10	10	50	150	-
	B-D12xd12x130xL75xZ2 H45	●	12	12	30	75	-
	B-D12xd12x145xL100xZ2 H45	●	12	12	45	100	-
	B-D12xd12x150xL150xZ2 H45	●	12	12	50	150	-
	B-D14xd14x140xL80xZ2 H45	●	14	14	40	80	-
	B-D14xd14x150xL100xZ2 H45	●	14	14	50	100	-
	B-D14xd14x150xL150xZ2 H45	●	14	14	50	150	-
	B-D16xd16x145xL100xZ2 H45	●	16	16	45	100	-
	B-D16xd16x150xL150xZ2 H45	●	16	16	50	150	-
	B-D18xd18x145xL100xZ2 H45	●	18	18	45	100	-
	B-D18xd18x150xL150xZ2 H45	●	18	18	50	150	-
	B-D20xd20x145xL100xZ2 H45	●	20	20	45	100	-
	B-D20xd20x175xL150xZ2 H45	●	20	20	75	150	-

TURNING

GROOVING

THREADING

MILLING

DRILLING

ENDMILLS

DRILLS

SPARE PARTS

INDEX

타입

Ball (볼타입)

UP TO HRC55 (HRC 55이하)

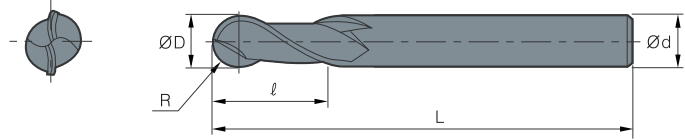

그림번호

나사

입력

인테이크 드릴

엔드밀

솔리드 드릴

부품

색인표



DESCRIPTION 형번	STOCK 재고	DIMENSIONS 치수				
		ØD	Ød	l	L	r
B-D1xd4xl3xL50xZ2 H55	●	1	4	3	50	-
B-D1xd6xl3xL50xZ2 H55	●	1	6	3	50	-
B-D1,5xd4xl4xL50xZ2 H55	●	1,5	4	4	50	-
B-D1,5xd6xl4xL50xZ2 H55	●	1,5	6	4	50	-
B-D2xd4xl6xL50xZ2 H55	●	2	4	6	50	-
B-D2xd6xl6xL50xZ2 H55	●	2	6	6	50	-
B-D2,5xd4xl8xL50xZ2 H55	●	2,5	4	8	50	-
B-D2,5xd6xl8xL50xZ2 H55	●	2,5	6	8	50	-
B-D3xd3xl8xL50xZ2 H55	●	3	3	8	50	-
B-D3xd4xl8xL50xZ2 H55	●	3	4	8	50	-
B-D3xd6xl8xL50xZ2 H55	●	3	6	8	50	-
B-D3,5xd4xl11xL50xZ2 H55	●	3,5	4	11	50	-
B-D3,5xd6xl11xL50xZ2 H55	●	3,5	6	11	50	-
B-D4xd4xl11xL50xZ2 H55	●	4	4	11	50	-
B-D4xd6xl11xL50xZ2 H55	●	4	6	11	50	-
B-D4xd4xl20xL75xZ2 H55	●	4	4	20	75	-
B-D4xd4xl20xL100xZ2 H55	●	4	4	20	100	-
B-D5xd5xl13xL50xZ2 H55	●	5	5	13	50	-
B-D5xd6xl13xL50xZ2 H55	●	5	6	13	50	-
B-D5xd5xl20xL75xZ2 H55	●	5	5	20	75	-
B-D5xd5xl20xL100xZ2 H55	●	5	5	20	100	-
B-D6xd6xl15xL50xZ2 H55	●	6	6	15	50	-
B-D6xd6xl20xL75xZ2 H55	●	6	6	20	75	-

Ball (볼타입)

UP TO HRC55 (HRc 55이하)

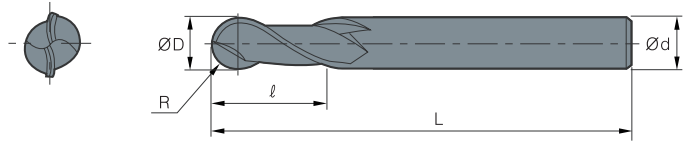

	DESCRIPTION 형번	STOCK 재고	DIMENSIONS 치수				
			ØD	Ød	l	L	r
	B-D6xd6x125xL100xZ2 H55	●	6	6	25	100	-
	B-D6xd6x140xL150xZ2 H55	●	6	6	40	150	-
	B-D7xd8x120xL60xZ2 H55	●	7	8	20	60	-
	B-D8xd8x120xL60xZ2 H55	●	8	8	20	60	-
	B-D8xd8x125xL75xZ2 H55	●	8	8	25	75	-
	B-D8xd8x140xL150xZ2 H55	●	8	8	40	150	-
	B-D9xd10x125xL75xZ2 H55	●	9	10	25	75	-
	B-D10xd10x125xL75xZ2 H55	●	10	10	25	75	-
	B-D10xd10x140xL100xZ2 H55	●	10	10	40	100	-
	B-D10xd10x150xL150xZ2 H55	●	10	10	50	150	-
	B-D12xd12x130xL75xZ2 H55	●	12	12	30	75	-
	B-D12xd12x145xL100xZ2 H55	●	12	12	45	100	-
	B-D12xd12x150xL150xZ2 H55	●	12	12	50	150	-
	B-D14xd14x140xL80xZ2 H55	●	14	14	40	80	-
	B-D14xd14x150xL100xZ2 H55	●	14	14	50	100	-
	B-D14xd14x150xL150xZ2 H55	●	14	14	50	150	-
	B-D16xd16x145xL100xZ2 H55	●	16	16	45	100	-
	B-D16xd16x150xL150xZ2 H55	●	16	16	50	150	-
	B-D18xd18x145xL100xZ2 H55	●	18	18	45	100	-
	B-D18xd18x150xL150xZ2 H55	●	18	18	50	150	-
	B-D20xd20x145xL100xZ2 H55	●	20	20	45	100	-
	B-D20xd20x175xL150xZ2 H55	●	20	20	75	150	-

TURNING

GROOVING

THREADING

MILLING

DRILLING

ENDMILLS

DRILLS

SPARE PARTS

INDEX

터닝

그라인딩

나사

밀링

인테리블 드릴

엔드밀

솔리드 드릴

부품

색인표

Ball (볼타입)

UP TO HRC68 (HRc 68이하)

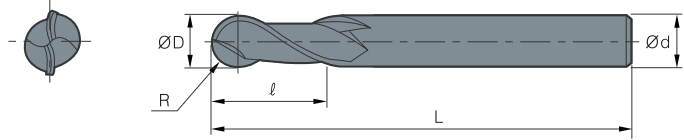

	DESCRIPTION 형번	STOCK 재고	DIMENSIONS 치수				
			ØD	Ød	l	L	r
	B-D1xd4xl3xL50xZ2 H68	●	1	4	3	50	-
	B-D1xd6xl3xL50xZ2 H68	●	1	6	3	50	-
	B-D1,5xd4xl4xL50xZ2 H68	●	1,5	4	4	50	-
	B-D1,5xd6xl4xL50xZ2 H68	●	1,5	6	4	50	-
	B-D2xd4xl6xL50xZ2 H68	●	2	4	6	50	-
	B-D2xd6xl6xL50xZ2 H68	●	2	6	6	50	-
	B-D2,5xd4xl8xL50xZ2 H68	●	2,5	4	8	50	-
	B-D2,5xd6xl8xL50xZ2 H68	●	2,5	6	8	50	-
	B-D3xd3xl8xL50xZ2 H68	●	3	3	8	50	-
	B-D3xd4xl8xL50xZ2 H68	●	3	4	8	50	-
	B-D3xd6xl8xL50xZ2 H68	●	3	6	8	50	-
	B-D3,5xd4xl11xL50xZ2 H68	●	3,5	4	11	50	-
	B-D3,5xd6xl11xL50xZ2 H68	●	3,5	6	11	50	-
	B-D4xd4xl11xL50xZ2 H68	●	4	4	11	50	-
	B-D4xd6xl11xL50xZ2 H68	●	4	6	11	50	-
	B-D4xd4xl20xL75xZ2 H68	●	4	4	20	75	-
	B-D4xd4xl20xL100xZ2 H68	●	4	4	20	100	-
	B-D5xd5xl13xL50xZ2 H68	●	5	5	13	50	-
	B-D5xd6xl13xL50xZ2 H68	●	5	6	13	50	-
	B-D5xd5xl20xL75xZ2 H68	●	5	5	20	75	-
	B-D5xd5xl20xL100xZ2 H68	●	5	5	20	100	-
	B-D6xd6xl15xL50xZ2 H68	●	6	6	15	50	-
	B-D6xd6xl20xL75xZ2 H68	●	6	6	20	75	-

ENDMILLS 엔드밀

Ball (볼타입)

UP TO HRC68 (HRc 68이하)

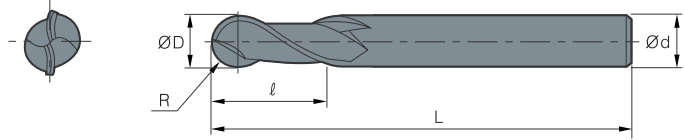

	DESCRIPTION 형번	STOCK 재고	DIMENSIONS 치수				
			ØD	Ød	l	L	r
	B-D6xd6x125xL100xZ2 H68	●	6	6	25	100	-
	B-D6xd6x140xL150xZ2 H68	●	6	6	40	150	-
	B-D7xd8x120xL60xZ2 H68	●	7	8	20	60	-
	B-D8xd8x120xL60xZ2 H68	●	8	8	20	60	-
	B-D8xd8x125xL75xZ2 H68	●	8	8	25	75	-
	B-D8xd8x140xL150xZ2 H68	●	8	8	40	150	-
	B-D9xd10x125xL75xZ2 H68	●	9	10	25	75	-
	B-D10xd10x125xL75xZ2 H68	●	10	10	25	75	-
	B-D10xd10x140xL100xZ2 H68	●	10	10	40	100	-
	B-D10xd10x150xL150xZ2 H68	●	10	10	50	150	-
	B-D12xd12x130xL75xZ2 H68	●	12	12	30	75	-
	B-D12xd12x145xL100xZ2 H68	●	12	12	45	100	-
	B-D12xd12x150xL150xZ2 H68	●	12	12	50	150	-
	B-D14xd14x140xL80xZ2 H68	●	14	14	40	80	-
	B-D14xd14x150xL100xZ2 H68	●	14	14	50	100	-
	B-D14xd14x150xL150xZ2 H68	●	14	14	50	150	-
	B-D16xd16x145xL100xZ2 H68	●	16	16	45	100	-
	B-D16xd16x150xL150xZ2 H68	●	16	16	50	150	-
	B-D18xd18x145xL100xZ2 H68	●	18	18	45	100	-
	B-D18xd18x150xL150xZ2 H68	●	18	18	50	150	-
	B-D20xd20x145xL100xZ2 H68	●	20	20	45	100	-
	B-D20xd20x175xL150xZ2 H68	●	20	20	75	150	-

TURNING

GROOVING

THREADING

MILLING

DRILLING

ENDMILLS

DRILLS

SPARE PARTS

INDEX

터닝

그라인딩

나사

밀링

인테이크 드릴

엔드밀

솔리드 드릴

부품

색인표

Radius(레디우스 타입)

UP TO HRC45 (HRc 45이하)

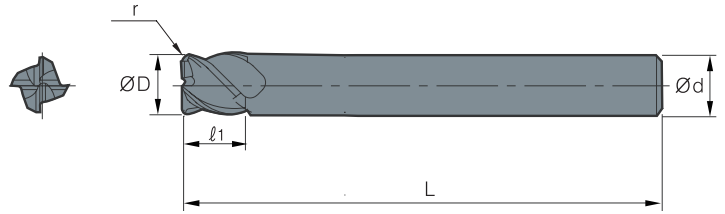

	DESCRIPTION 형번	STOCK 재고	DIMENSIONS 치수				
			ØD	Ød	l	L	r
	R-D2xd4xl6xL50-R0.5xZ4 H45	●	2	4	6	50	0.5
	R-D2xd6xl6xL50-R0.5xZ4 H45	●	2	6	6	50	0.5
	R-D3xd3xl8xL50-R0.5xZ4 H45	●	3	3	8	50	0.5
	R-D3xd3xl8xL50-R1.0xZ4 H45	●	3	3	8	50	1.0
	R-D3xd4xl8xL50-R0.5xZ4 H45	●	3	4	8	50	0.5
	R-D3xd4xl8xL50-R1.0xZ4 H45	●	3	4	8	50	1.0
	R-D3xd6xl8xL50-R0.5xZ4 H45	●	3	6	8	50	0.5
	R-D3xd6xl8xL50-R1.0xZ4 H45	●	3	6	8	50	1.0
	R-D4xd4xl11xL50-R0.5xZ4 H45	●	4	4	11	50	0.5
	R-D4xd4xl11xL50-R1.0xZ4 H45	●	4	4	11	50	1.0
	R-D4xd6xl11xL50-R0.5xZ4 H45	●	4	6	11	50	0.5
	R-D4xd6xl11xL50-R1.0xZ4 H45	●	4	6	11	50	1.0
	R-D4xd4xl11xL75-R0.5xZ4 H45	●	4	4	11	75	0.5
	R-D4xd4xl11xL75-R1.0xZ4 H45	●	4	4	11	75	1.0
	R-D4xd4xl11xL100-R0.5xZ4 H45	●	4	4	11	100	0.5
	R-D4xd4xl11xL100-R1.0xZ4 H45	●	4	4	11	100	1.0
	R-D5xd5xl13xL50-R0.5xZ4 H45	●	5	5	13	50	0.5
	R-D5xd5xl13xL50-R1.0xZ4 H45	●	5	5	13	50	1.0
	R-D5xd6xl13xL50-R0.5xZ4 H45	●	5	6	13	50	0.5
	R-D5xd6xl13xL50-R1.0xZ4 H45	●	5	6	13	50	1.0
	R-D5xd5xl13xL75-R0.5xZ4 H45	●	5	5	13	75	0.5
	R-D5xd5xl13xL75-R1.0xZ4 H45	●	5	5	13	75	1.0
	R-D5xd5xl13xL100-R1.0xZ4 H45	●	5	5	13	100	0.5
	R-D5xd5xl13xL100-R1.0xZ4 H45	●	5	5	13	100	1.0
	R-D6xd6xl15xL50-R0.5xZ4 H45	●	6	6	15	50	0.5

Radius(레디우스 타입)

UP TO HRC45 (HRc 45이하)

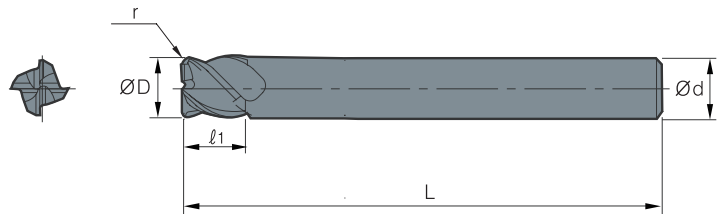

	DESCRIPTION 형번	STOCK 재고	DIMENSIONS 치수				
			ØD	Ød	l	L	r
	R-D6xd6xl15xL50-R1.0xZ4 H45	●	6	6	15	50	1.0
	R-D6xd6xl15xL75-R0.5xZ4 H45	●	6	6	15	75	0.5
	R-D6xd6xl15xL75-R1.0xZ4 H45	●	6	6	15	75	1.0
	R-D6xd6xl15xL100-R1.0xZ4 H45	●	6	6	15	100	0.5
	R-D6xd6xl15xL100-R1.0xZ4 H45	●	6	6	15	100	1.0
	R-D6xd6xl40xL150-R0.5xZ4 H45	●	6	6	40	150	0.5
	R-D6xd6xl40xL150-R1.0xZ4 H45	●	6	6	40	150	1.0
	R-D7xd8xl20xL60-R0.5xZ4 H45	●	7	8	20	60	0.5
	R-D7xd8xl20xL60-R1.0xZ4 H45	●	7	8	20	60	1.0
	R-D8xd8xl20xL60-R0.5xZ4 H45	●	8	8	20	60	0.5
	R-D8xd8xl20xL60-R1.0xZ4 H45	●	8	8	20	60	1.0
	R-D8xd8xl20xL75-R1.0xZ4 H45	●	8	8	20	75	0.5
	R-D8xd8xl20xL75-R1.0xZ4 H45	●	8	8	20	75	1.0
	R-D8xd8xl20xL100-R0.5xZ4 H45	●	8	8	20	100	0.5
	R-D8xd8xl20xL100-R1.0xZ4 H45	●	8	8	20	100	1.0
	R-D8xd8xl40xL150-R0.5xZ4 H45	●	8	8	40	150	0.5
	R-D8xd8xl40xL150-R1.0xZ4 H45	●	8	8	40	150	1.0
	R-D9xd10xl25xL75-R0.5xZ4 H45	●	9	10	25	75	0.5
	R-D9xd10xl25xL75-R1.0xZ4 H45	●	9	10	25	75	1.0
	R-D10xd10xl25xL75-R0.5xZ4 H45	●	10	10	25	75	0.5
	R-D10xd10xl25xL75-R1.0xZ4 H45	●	10	10	25	75	1.0
	R-D10xd10xl40xL100-R0.5xZ4 H45	●	10	10	40	100	0.5
	R-D10xd10xl40xL100-R1.0xZ4 H45	●	10	10	40	100	1.0
	R-D10xd10xl50xL150-R0.5xZ4 H45	●	10	10	50	150	0.5
	R-D10xd10xl50xL150-R1.0xZ4 H45	●	10	10	50	150	1.0

TURNING

GROOVING

THREADING

MILLING

DRILLING

ENDMILLS

DRILLS

SPARE PARTS

INDEX

터닝

그라인딩

나사

밀링

인테이크 드릴

엔드밀

솔리드 드릴

부품

색인표

Radius(레디우스 타입)

UP TO HRC45 (HRc 45이하)

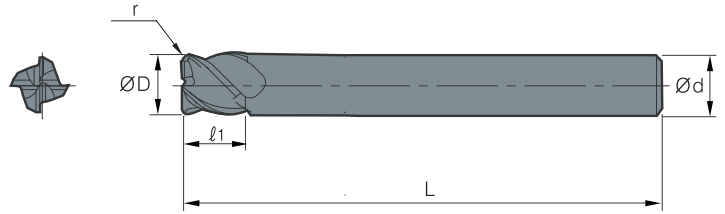

DESCRIPTION 형번	STOCK 재고	DIMENSIONS 치수				
		ØD	Ød	l	L	r
R-D12xd12x30xL75-R0.5xZ4 H45	●	12	12	30	75	0.5
R-D12xd12x30xL75-R1.0xZ4 H45	●	12	12	30	75	1.0
R-D12xd12x45xL100-R0.5xZ4 H45	●	12	12	45	100	0.5
R-D12xd12x45xL100-R1.0xZ4 H45	●	12	12	45	100	1.0
R-D12xd12x50xL150-R0.5xZ4 H45	●	12	12	50	150	0.5
R-D12xd12x50xL150-R1.0xZ4 H45	●	12	12	50	150	1.0
R-D14xd14x40xL80-R0.5xZ4 H45	●	14	14	40	80	0.5
R-D14xd14x40xL80-R1.0xZ4 H45	●	14	14	40	80	1.0
R-D14xd14x50xL100-R0.5xZ4 H45	●	14	14	50	100	0.5
R-D14xd14x50xL100-R1.0xZ4 H45	●	14	14	50	100	1.0
R-D14xd14x50xL150-R0.5xZ4 H45	●	14	14	50	150	0.5
R-D14xd14x50xL150-R1.0xZ4 H45	●	14	14	50	150	1.0
R-D16xd16x45xL100-R0.5xZ4 H45	●	16	16	45	100	0.5
R-D16xd16x45xL100-R1.0xZ4 H45	●	16	16	45	100	1.0
R-D16xd16x50xL150-R0.5xZ4 H45	●	16	16	50	150	0.5
R-D16xd16x50xL150-R1.0xZ4 H45	●	16	16	50	150	1.0
R-D18xd18x45xL100-R0.5xZ4 H45	●	18	18	45	100	0.5
R-D18xd18x45xL100-R1.0xZ4 H45	●	18	18	45	100	1.0
R-D18xd18x50xL150-R0.5xZ4 H45	●	18	18	50	150	0.5
R-D18xd18x50xL150-R1.0xZ4 H45	●	18	18	50	150	1.0
R-D20xd20x45xL100-R0.5xZ4 H45	●	20	20	45	100	0.5
R-D20xd20x45xL100-R1.0xZ4 H45	●	20	20	45	100	1.0
R-D20xd20x75xL150-R0.5xZ4 H45	●	20	20	75	150	0.5
R-D20xd20x75xL150-R1.0xZ4 H45	●	20	20	75	150	1.0

Radius(레디우스 타입)

UP TO HRC55 (HRc 55이하)

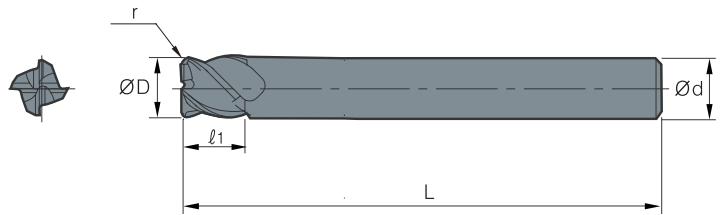

	DESCRIPTION 형번	STOCK 재고	DIMENSIONS 치수				
			ØD	Ød	l	L	r
	R-D2xd4xl6xL50-R0.5xZ4 H55	●	2	4	6	50	0.5
	R-D2xd6xl6xL50-R0.5xZ4 H55	●	2	6	6	50	0.5
	R-D3xd3xl8xL50-R0.5xZ4 H55	●	3	3	8	50	0.5
	R-D3xd3xl8xL50-R1.0xZ4 H55	●	3	3	8	50	1.0
	R-D3xd4xl8xL50-R0.5xZ4 H55	●	3	4	8	50	0.5
	R-D3xd4xl8xL50-R1.0xZ4 H55	●	3	4	8	50	1.0
	R-D3xd6xl8xL50-R0.5xZ4 H55	●	3	6	8	50	0.5
	R-D3xd6xl8xL50-R1.0xZ4 H55	●	3	6	8	50	1.0
	R-D4xd4xl11xL50-R0.5xZ4 H55	●	4	4	11	50	0.5
	R-D4xd4xl11xL50-R1.0xZ4 H55	●	4	4	11	50	1.0
	R-D4xd6xl11xL50-R0.5xZ4 H55	●	4	6	11	50	0.5
	R-D4xd6xl11xL50-R1.0xZ4 H55	●	4	6	11	50	1.0
	R-D4xd4xl20xL75-R0.5xZ4 H55	●	4	4	20	75	0.5
	R-D4xd4xl20xL75-R1.0xZ4 H55	●	4	4	20	75	1.0
	R-D4xd4xl20xL100-R0.5xZ4 H55	●	4	4	20	100	0.5
	R-D4xd4xl20xL100-R1.0xZ4 H55	●	4	4	20	100	1.0
	R-D5xd5xl13xL50-R0.5xZ4 H55	●	5	5	13	50	0.5
	R-D5xd5xl13xL50-R1.0xZ4 H55	●	5	5	13	50	1.0
	R-D5xd6xl13xL50-R0.5xZ4 H55	●	5	6	13	50	0.5
	R-D5xd6xl13xL50-R1.0xZ4 H55	●	5	6	13	50	1.0
	R-D5xd5xl20xL75-R0.5xZ4 H55	●	5	5	20	75	0.5
	R-D5xd5xl20xL75-R1.0xZ4 H55	●	5	5	20	75	1.0
	R-D5xd5xl20xL100-R0.5xZ4 H55	●	5	5	20	100	0.5
	R-D5xd5xl20xL100-R1.0xZ4 H55	●	5	5	20	100	1.0
	R-D6xd6xl15xL50-R0.5xZ4 H55	●	6	6	15	50	0.5

TURNING

GROOVING

THREADING

MILLING

DRILLING

ENDMILLS

DRILLS

SPARE PARTS

INDEX

터너

그라운드

나사

밀링

인테이크 드릴

엔드밀

솔리드 드릴

부품

색인표

Radius(레디우스 타입)

UP TO HRC55 (HRc 55이하)

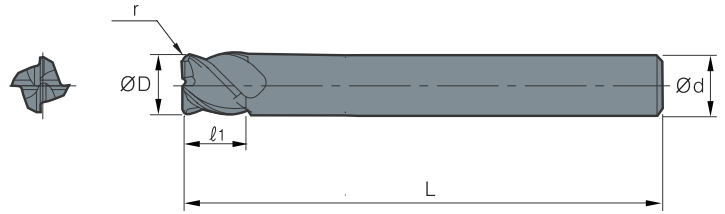

	DESCRIPTION 형번	STOCK 재고	DIMENSIONS 치수				
			ØD	Ød	l	L	r
	R-D6xd6x115xL50-R1.0xZ4 H55	●	6	6	15	50	1.0
	R-D6xd6x120xL75-R0.5xZ4 H55	●	6	6	20	75	0.5
	R-D6xd6x120xL75-R1.0xZ4 H55	●	6	6	20	75	1.0
	R-D6xd6x125xL100-R0.5xZ4 H55	●	6	6	25	100	0.5
	R-D6xd6x125xL100-R1.0xZ4 H55	●	6	6	25	100	1.0
	R-D6xd6x140xL150-R0.5xZ4 H55	●	6	6	40	150	0.5
	R-D6xd6x140xL150-R1.0xZ4 H55	●	6	6	40	150	1.0
	R-D7xd8x120xL60-R0.5xZ4 H55	●	7	8	20	60	0.5
	R-D7xd8x120xL60-R1.0xZ4 H55	●	7	8	20	60	1.0
	R-D8xd8x120xL60-R0.5xZ4 H55	●	8	8	20	60	0.5
	R-D8xd8x120xL60-R1.0xZ4 H55	●	8	8	20	60	1.0
	R-D8xd8x125xL75-R0.5xZ4 H55	●	8	8	25	75	0.5
	R-D8xd8x125xL75-R1.0xZ4 H55	●	8	8	25	75	1.0
	R-D8xd8x140xL100-R0.5xZ4 H55	●	8	8	40	100	0.5
	R-D8xd8x140xL100-R1.0xZ4 H55	●	8	8	40	100	1.0
	R-D8xd8x140xL150-R0.5xZ4 H55	●	8	8	40	150	0.5
	R-D8xd8x140xL150-R1.0xZ4 H55	●	8	8	40	150	1.0
	R-D9xd10x125xL75-R0.5xZ4 H55	●	9	10	25	75	0.5
	R-D9xd10x125xL75-R1.0xZ4 H55	●	9	10	25	75	1.0
	R-D10xd10x125xL75-R0.5xZ4 H55	●	10	10	25	75	0.5
	R-D10xd10x125xL75-R1.0xZ4 H55	●	10	10	25	75	1.0
	R-D10xd10x140xL100-R0.5xZ4 H55	●	10	10	40	100	0.5
	R-D10xd10x140xL100-R1.0xZ4 H55	●	10	10	40	100	1.0
	R-D10xd10x150xL150-R0.5xZ4 H55	●	10	10	50	150	0.5
	R-D10xd10x150xL150-R1.0xZ4 H55	●	10	10	50	150	1.0

Radius(레디우스 타입)

UP TO HRC55 (HRc 55이하)

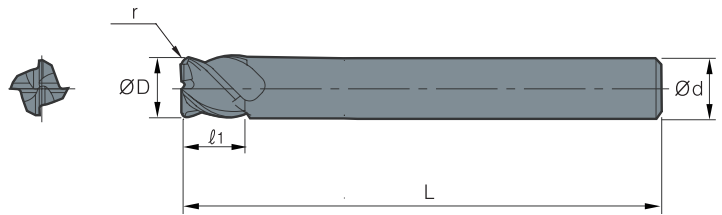

	DESCRIPTION 형번	STOCK 재고	DIMENSIONS 치수				
			ØD	Ød	l	L	r
	R-D12xd12x30xL75-R0.5xZ4 H55	●	12	12	30	75	0.5
	R-D12xd12x30xL75-R1.0xZ4 H55	●	12	12	30	75	1.0
	R-D12xd12x45xL100-R1.0xZ4 H55	●	12	12	45	100	0.5
	R-D12xd12x45xL100-R1.0xZ4 H55	●	12	12	45	100	1.0
	R-D12xd12x50xL150-R0.5xZ4 H55	●	12	12	50	150	0.5
	R-D12xd12x50xL150-R1.0xZ4 H55	●	12	12	50	150	1.0
	R-D14xd14x40xL80-R0.5xZ4 H55	●	14	14	40	80	0.5
	R-D14xd14x40xL80-R1.0xZ4 H55	●	14	14	40	80	1.0
	R-D14xd14x50xL100-R0.5xZ4 H55	●	14	14	50	100	0.5
	R-D14xd14x50xL100-R1.0xZ4 H55	●	14	14	50	100	1.0
	R-D14xd14x50xL150-R0.5xZ4 H55	●	14	14	50	150	0.5
	R-D14xd14x50xL150-R1.0xZ4 H55	●	14	14	50	150	1.0
	R-D16xd16x45xL100-R0.5xZ4 H55	●	16	16	45	100	0.5
	R-D16xd16x45xL100-R1.0xZ4 H55	●	16	16	45	100	1.0
	R-D16xd16x50xL150-R0.5xZ4 H55	●	16	16	50	150	0.5
	R-D16xd16x50xL150-R1.0xZ4 H55	●	16	16	50	150	1.0
	R-D18xd18x45xL100-R0.5xZ4 H55	●	18	18	45	100	0.5
	R-D18xd18x45xL100-R1.0xZ4 H55	●	18	18	45	100	1.0
	R-D18xd18x50xL150-R0.5xZ4 H55	●	18	18	50	150	0.5
	R-D18xd18x50xL150-R1.0xZ4 H55	●	18	18	50	150	1.0
	R-D20xd20x45xL100-R0.5xZ4 H55	●	20	20	45	100	0.5
	R-D20xd20x45xL100-R1.0xZ4 H55	●	20	20	45	100	1.0
	R-D20xd20x75xL150-R0.5xZ4 H55	●	20	20	75	150	0.5
	R-D20xd20x75xL150-R1.0xZ4 H55	●	20	20	75	150	1.0

TURNING

GROOVING

THREADING

MILLING

DRILLING

ENDMILLS

DRILLS

SPARE PARTS

INDEX

터닝

그라인드

나사

밀링

인테그럴 드릴

엔드밀

솔리드 드릴

부품

색인표

Radius(레디우스 타입)

UP TO HRC68 (HRc 68이하)

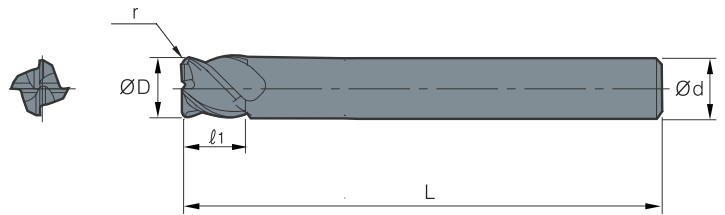

	DESCRIPTION 형번	STOCK 재고	DIMENSIONS 치수				
			ØD	Ød	l	L	r
	R-D2xd4xl6xL50-R0.5xZ4 H68	●	2	4	6	50	0.5
	R-D2xd6xl6xL50-R0.5xZ4 H68	●	2	6	6	50	0.5
	R-D3xd3xl8xL50-R0.5xZ4 H68	●	3	3	8	50	0.5
	R-D3xd3xl8xL50-R1.0xZ4 H68	●	3	3	8	50	1.0
	R-D3xd4xl8xL50-R0.5xZ4 H68	●	3	4	8	50	0.5
	R-D3xd4xl8xL50-R1.0xZ4 H68	●	3	4	8	50	1.0
	R-D3xd6xl8xL50-R0.5xZ4 H68	●	3	6	8	50	0.5
	R-D3xd6xl8xL50-R1.0xZ4 H68	●	3	6	8	50	1.0
	R-D4xd4xl11xL50-R0.5xZ4 H68	●	4	4	11	50	0.5
	R-D4xd4xl11xL50-R1.0xZ4 H68	●	4	4	11	50	1.0
	R-D4xd6xl11xL50-R0.5xZ4 H68	●	4	6	11	50	0.5
	R-D4xd6xl11xL50-R1.0xZ4 H68	●	4	6	11	50	1.0
	R-D4xd4xl20xL75-R0.5xZ4 H68	●	4	4	20	75	0.5
	R-D4xd4xl20xL75-R1.0xZ4 H68	●	4	4	20	75	1.0
	R-D4xd4xl20xL100-R0.5xZ4 H68	●	4	4	20	100	0.5
	R-D4xd4xl20xL100-R1.0xZ4 H68	●	4	4	20	100	1.0
	R-D5xd5xl13xL50-R0.5xZ4 H68	●	5	5	13	50	0.5
	R-D5xd5xl13xL50-R1.0xZ4 H68	●	5	5	13	50	1.0
	R-D5xd6xl13xL50-R0.5xZ4 H68	●	5	6	13	50	0.5
	R-D5xd6xl13xL50-R1.0xZ4 H68	●	5	6	13	50	1.0
	R-D5xd5xl20xL75-R0.5xZ4 H68	●	5	5	20	75	0.5
	R-D5xd5xl20xL75-R1.0xZ4 H68	●	5	5	20	75	1.0
	R-D5xd5xl20xL100-R0.5xZ4 H68	●	5	5	20	100	0.5
	R-D5xd5xl20xL100-R1.0xZ4 H68	●	5	5	20	100	1.0
	R-D6xd6xl15xL50-R0.5xZ4 H68	●	6	6	15	50	0.5

Radius(레디우스 타입)

UP TO HRC68 (HRc 68이하)

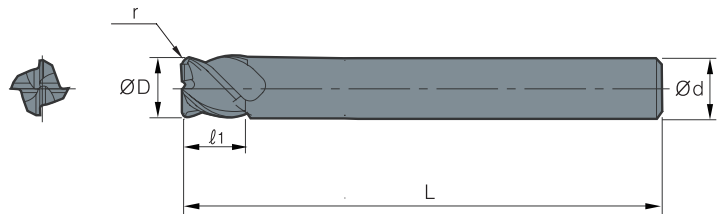

	DESCRIPTION 형번	STOCK 재고	DIMENSIONS 치수				
			ØD	Ød	l	L	r
	R-D6xd6xl15xL50-R1.0xZ4 H68	●	6	6	15	50	1.0
	R-D6xd6xl20xL75-R0.5xZ4 H68	●	6	6	20	75	0.5
	R-D6xd6xl20xL75-R1.0xZ4 H68	●	6	6	20	75	1.0
	R-D6xd6xl25xL100-R0.5xZ4 H68	●	6	6	25	100	0.5
	R-D6xd6xl25xL100-R1.0xZ4 H68	●	6	6	25	100	1.0
	R-D6xd6xl40xL150-R0.5xZ4 H68	●	6	6	40	150	0.5
	R-D6xd6xl40xL150-R1.0xZ4 H68	●	6	6	40	150	1.0
	R-D7xd8xl20xL60-R0.5xZ4 H68	●	7	8	20	60	0.5
	R-D7xd8xl20xL60-R1.0xZ4 H68	●	7	8	20	60	1.0
	R-D8xd8xl20xL60-R0.5xZ4 H68	●	8	8	20	60	0.5
	R-D8xd8xl20xL60-R1.0xZ4 H68	●	8	8	20	60	1.0
	R-D8xd8xl25xL75-R0.5xZ4 H68	●	8	8	25	75	0.5
	R-D8xd8xl25xL75-R1.0xZ4 H68	●	8	8	25	75	1.0
	R-D8xd8xl40xL100-R0.5xZ4 H68	●	8	8	40	100	0.5
	R-D8xd8xl40xL100-R1.0xZ4 H68	●	8	8	40	100	1.0
	R-D8xd8xl40xL150-R0.5xZ4 H68	●	8	8	40	150	0.5
	R-D8xd8xl40xL150-R1.0xZ4 H68	●	8	8	40	150	1.0
	R-D9xd10xl25xL75-R0.5xZ4 H68	●	9	10	25	75	0.5
	R-D9xd10xl25xL75-R1.0xZ4 H68	●	9	10	25	75	1.0
	R-D10xd10xl25xL75-R0.5xZ4 H68	●	10	10	25	75	0.5
	R-D10xd10xl25xL75-R1.0xZ4 H68	●	10	10	25	75	1.0
	R-D10xd10xl40xL100-R0.5xZ4 H68	●	10	10	40	100	0.5
	R-D10xd10xl40xL100-R1.0xZ4 H68	●	10	10	40	100	1.0
	R-D10xd10xl50xL150-R0.5xZ4 H68	●	10	10	50	150	0.5
	R-D10xd10xl50xL150-R1.0xZ4 H68	●	10	10	50	150	1.0

TURNING

GROOVING

THREADING

MILLING

DRILLING

ENDMILLS

DRILLS

SPARE PARTS

INDEX

타입

Radius(레디우스 타입)

UP TO HRC68 (HRC 68이하)

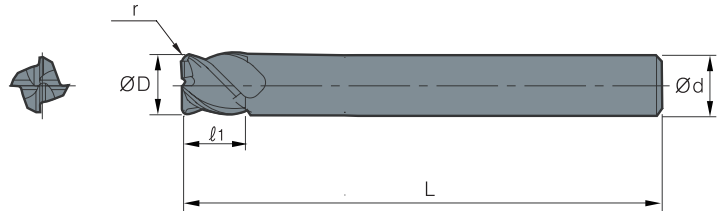

그루브

나사

밀링

인테이크 드릴

엔드밀

슬리드 드릴

부품

색인표



DESCRIPTION 형번	STOCK 재고	DIMENSIONS 치수				
		ØD	Ød	l	L	r
R-D12xd12x30xL75-R0.5xZ4 H68	●	12	12	30	75	0.5
R-D12xd12x30xL75-R1.0xZ4 H68	●	12	12	30	75	1.0
R-D12xd12x45xL100-R0.5xZ4 H68	●	12	12	45	100	0.5
R-D12xd12x45xL100-R1.0xZ4 H68	●	12	12	45	100	1.0
R-D12xd12x50xL150-R0.5xZ4 H68	●	12	12	50	150	0.5
R-D12xd12x50xL150-R1.0xZ4 H68	●	12	12	50	150	1.0
R-D14xd14x40xL80-R0.5xZ4 H68	●	14	14	40	80	0.5
R-D14xd14x40xL80-R1.0xZ4 H68	●	14	14	40	80	1.0
R-D14xd14x50xL100-R0.5xZ4 H68	●	14	14	50	100	0.5
R-D14xd14x50xL100-R1.0xZ4 H68	●	14	14	50	100	1.0
R-D14xd14x50xL150-R0.5xZ4 H68	●	14	14	50	150	0.5
R-D14xd14x50xL150-R1.0xZ4 H68	●	14	14	50	150	1.0
R-D16xd16x45xL100-R0.5xZ4 H68	●	16	16	45	100	0.5
R-D16xd16x45xL100-R1.0xZ4 H68	●	16	16	45	100	1.0
R-D16xd16x50xL150-R0.5xZ4 H68	●	16	16	50	150	0.5
R-D16xd16x50xL150-R1.0xZ4 H68	●	16	16	50	150	1.0
R-D18xd18x45xL100-R0.5xZ4 H68	●	18	18	45	100	0.5
R-D18xd18x45xL100-R1.0xZ4 H68	●	18	18	45	100	1.0
R-D18xd18x50xL150-R0.5xZ4 H68	●	18	18	50	150	0.5
R-D18xd18x50xL150-R1.0xZ4 H68	●	18	18	50	150	1.0
R-D20xd20x45xL100-R0.5xZ4 H68	●	20	20	45	100	0.5
R-D20xd20x45xL100-R1.0xZ4 H68	●	20	20	45	100	1.0
R-D20xd20x75xL150-R0.5xZ4 H68	●	20	20	75	150	0.5
R-D20xd20x75xL150-R1.0xZ4 H68	●	20	20	75	150	1.0

Square (플랫 타입)

2Z / 2날

Uncoated Carbide
(비코팅 초경)

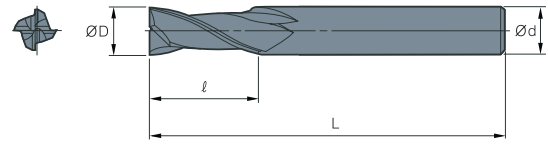

	DESCRIPTION 형번	STOCK 재고	DIMENSIONS 치수				
			ØD	Ød	l	L	r
	SAL-D1xd4xl3xL50xZ2 H45	●	1	4	3	50	-
	SAL-D1xd6xl3xL50xZ2 H45	●	1	6	3	50	-
	SAL-D2xd4xl6xL50xZ2 H45	●	2	4	6	50	-
	SAL-D2xd6xl6xL50xZ2 H45	●	2	6	6	50	-
	SAL-D3xd3xl8xL50xZ2 H45	●	3	3	8	50	-
	SAL-D3xd4xl8xL50xZ2 H45	●	3	4	8	50	-
	SAL-D3xd6xl8xL50xZ2 H45	●	3	6	8	50	-
	SAL-D4xd4xl11xL50xZ2 H45	●	4	4	11	50	-
	SAL-D4xd6xl11xL50xZ2 H45	●	4	6	11	50	-
	SAL-D4xd4xl20xL75xZ2 H45	●	4	4	20	75	-
	SAL-D4xd4xl20xL100xZ2 H45	●	4	4	20	100	-
	SAL-D5xd5xl13xL50xZ2 H45	●	5	5	13	50	-
	SAL-D5xd6xl13xL50xZ2 H45	●	5	6	13	50	-
	SAL-D5xd5xl20xL75xZ2 H45	●	5	5	20	75	-
	SAL-D5xd5xl20xL100xZ2 H45	●	5	5	20	100	-
	SAL-D6xd6xl15xL50xZ2 H45	●	6	6	15	50	-
	SAL-D6xd6xl20xL75xZ2 H45	●	6	6	20	75	-

TURNING

GROOVING

THREADING

MILLING

DRILLING

ENDMILLS

DRILLS

SPARE PARTS

INDEX

터닝

그라인딩

나사

밀링

인테리블 드릴

엔드밀

솔리드 드릴

부품

색인표

Square (플랫 타입)

2Z / 2날

Uncoated Carbide
(비코팅 초경)

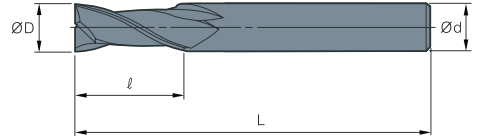

DESCRIPTION 형번	STOCK 재고	DIMENSIONS 치수				
		øD	ød	l	L	r
SAL-D6xd6xl25xL100xZ2 H45	●	6	6	25	100	-
SAL-D6xd6xl40xL150xZ2 H45	●	6	6	40	150	-
SAL-D8xd8xl20xL60xZ2 H45	●	8	8	20	60	-
SAL-D8xd8xl25xL75xZ2 H45	●	8	8	25	75	-
SAL-D8xd8xl40xL100xZ2 H45	●	8	8	40	100	-
SAL-D8xd8xl40xL150xZ2 H45	●	8	8	40	150	-
SAL-D10xd10xl25xL75xZ2 H45	●	10	10	25	75	-
SAL-D10xd10xl40xL100xZ2 H45	●	10	10	40	100	-
SAL-D12xd12xl30xL75xZ2 H45	●	12	12	30	75	-
SAL-D12xd12xl45xL100xZ2 H45	●	12	12	45	100	-
SAL-D12xd12xl50xL150xZ2 H45	●	12	12	50	150	-
SAL-D14xd14xl40xL80xZ2 H45	●	14	14	40	80	-
SAL-D14xd14xl50xL100xZ2 H45	●	14	14	50	100	-
SAL-D16xd16xl45xL100xZ2 H45	●	16	16	45	100	-
SAL-D18xd18xl45xL100xZ2 H45	●	18	18	45	100	-
SAL-D20xd20xl45xL100xZ2 H45	●	20	20	45	100	-
SAL-D20xd20xl75xL150xZ2 H45	●	20	20	75	150	-

Square (플랫 타입)

3Z / 3날

Uncoated Carbide
(비코팅 초경)

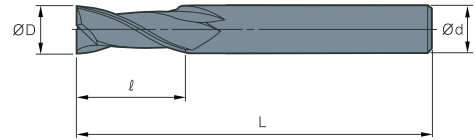

	DESCRIPTION 형번	STOCK 재고	DIMENSIONS 치수				
			øD	ød	l	L	r
	SAL-D1xd4xl3xL50xZ3 H45	●	1	4	3	50	-
	SAL-D1xd6xl3xL50xZ3 H45	●	1	6	3	50	-
	SAL-D2xd4xl6xL50xZ3 H45	●	2	4	6	50	-
	SAL-D2xd6xl6xL50xZ3 H45	●	2	6	6	50	-
	SAL-D3xd3xl8xL50xZ3 H45	●	3	3	8	50	-
	SAL-D3xd4xl8xL50xZ3 H45	●	3	4	8	50	-
	SAL-D3xd6xl8xL50xZ3 H45	●	3	6	8	50	-
	SAL-D4xd4xl11xL50xZ3 H45	●	4	4	11	50	-
	SAL-D4xd6xl11xL50xZ3 H45	●	4	6	11	50	-
	SAL-D4xd4xl20xL75xZ3 H45	●	4	4	20	75	-
	SAL-D4xd4xl20xL100xZ3 H45	●	4	4	20	100	-
	SAL-D5xd5xl13xL50xZ3 H45	●	5	5	13	50	-
	SAL-D5xd6xl13xL50xZ3 H45	●	5	6	13	50	-
	SAL-D5xd5xl20xL75xZ3 H45	●	5	5	20	75	-
	SAL-D5xd5xl20xL100xZ3 H45	●	5	5	20	100	-
	SAL-D6xd6xl15xL50xZ3 H45	●	6	6	15	50	-
	SAL-D6xd6xl20xL75xZ3 H45	●	6	6	20	75	-

- TURNING
- GROOVING
- THREADING
- MILLING
- DRILLING
- ENDMILLS
- DRILLS
- SPARE PARTS
- INDEX

터닝

Square (플랫 타입)

3Z / 3날

Uncoated Carbide
(비코팅 초경)

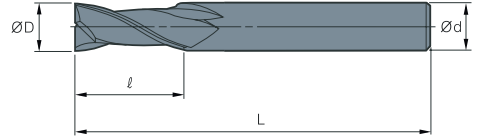

그라인드

나사

밀링

인테이크 드릴

엔드밀

솔리드 드릴

부품

색인표



	DESCRIPTION 형번	STOCK 재고	DIMENSIONS 치수				
			ØD	Ød	l	L	r
	SAL-D6xd6xL25xZ3 H45	●	6	6	25	100	-
	SAL-D6xd6xL40xZ3 H45	●	6	6	40	150	-
	SAL-D8xd8xL20xZ3 H45	●	8	8	20	60	-
	SAL-D8xd8xL25xZ3 H45	●	8	8	25	75	-
	SAL-D8xd8xL40xZ3 H45	●	8	8	40	100	-
	SAL-D8xd8xL40xL150xZ3 H45	●	8	8	40	150	-
	SAL-D10xd10xL25xZ3 H45	●	10	10	25	75	-
	SAL-D10xd10xL40xZ3 H45	●	10	10	40	100	-
	SAL-D12xd12xL30xZ3 H45	●	12	12	30	75	-
	SAL-D12xd12xL45xZ3 H45	●	12	12	45	100	-
	SAL-D12xd12xL50xZ3 H45	●	12	12	50	150	-
	SAL-D14xd14xL40xZ3 H45	●	14	14	40	80	-
	SAL-D14xd14xL50xZ3 H45	●	14	14	50	100	-
	SAL-D16xd16xL45xZ3 H45	●	16	16	45	100	-
	SAL-D18xd18xL45xZ3 H45	●	18	18	45	100	-
	SAL-D20xd20xL45xZ3 H45	●	20	20	45	100	-
	SAL-D20xd20xL75xZ3 H45	●	20	20	75	150	-

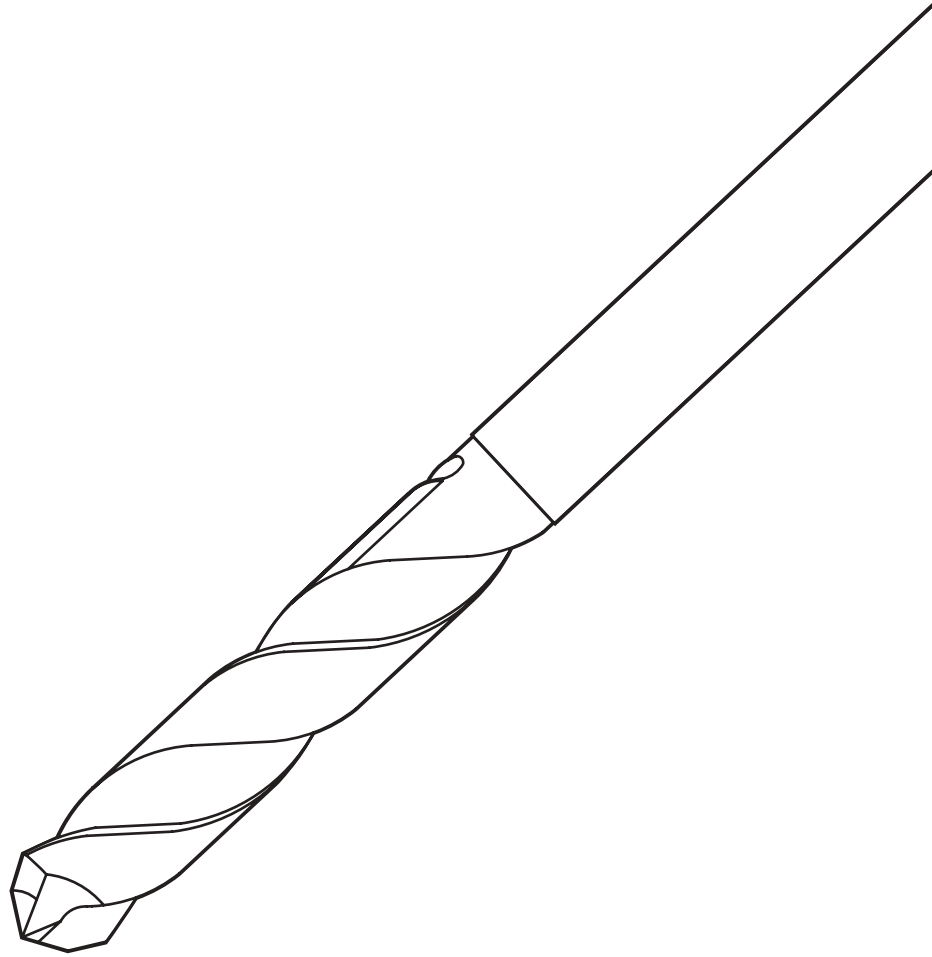

DRILLS/ 초경코팅드릴

초경코팅드릴 carbide /327

DRILLS / carbide

초경코팅드릴 / 초경코팅드릴

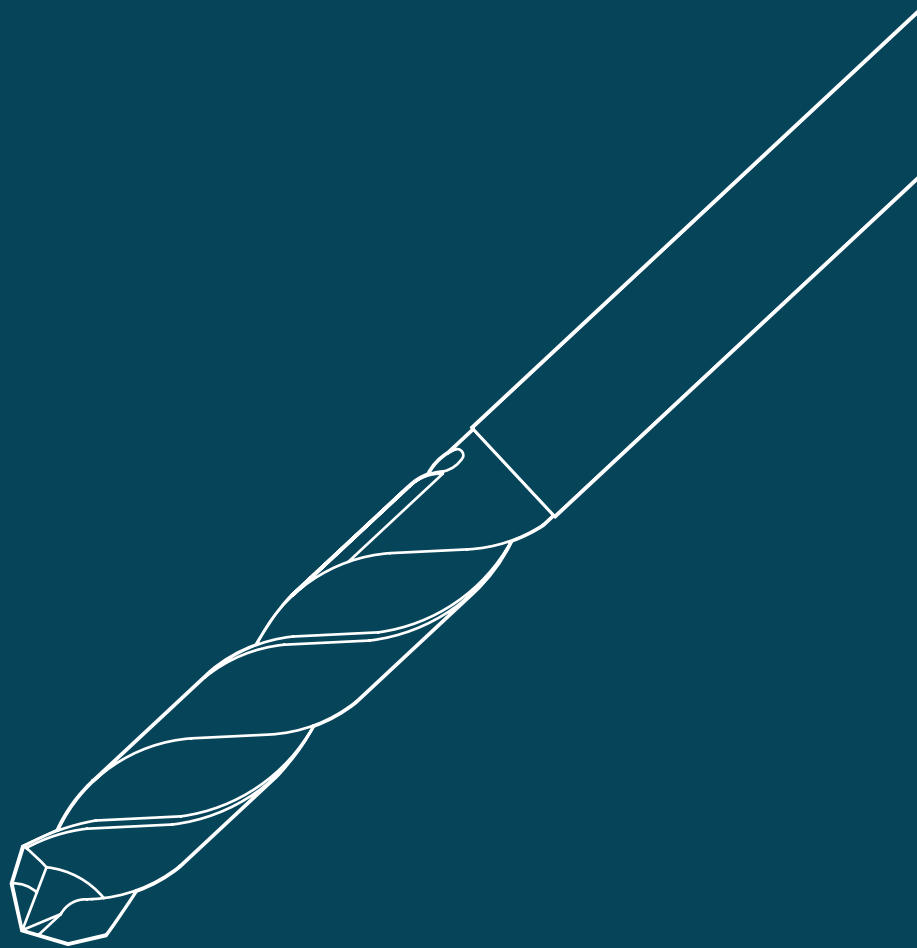

터닝

그루빙

나사

밀링

인테셔널 드릴

엔드밀

솔리드 드릴

부품

색인표

DSD

3XD

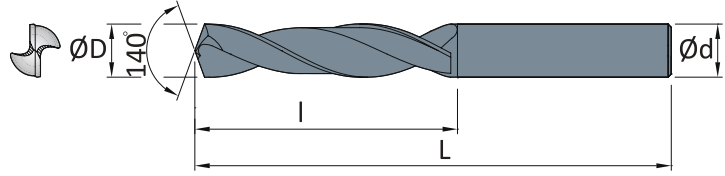

DESCRIPTION 형번	STOCK 재고	DIMENSIONS 치수			
		ØD	I	L	Ød
DSD 2010-35-3	●	1.0	7	35	3
2011-35-3	●	1.1	7	35	3
2012-35-3	●	1.2	8	35	3
2013-35-3	●	1.3	8	35	3
2014-35-3	●	1.4	9	35	3
2015-40-3	●	1.5	9	40	3
2016-40-3	●	1.6	10	40	3
2017-40-3	●	1.7	10	40	3
2018-40-3	●	1.8	11	40	3
2019-40-3	●	1.9	11	40	3
2020-45-3	●	2.0	13	45	3
2021-45-3	●	2.1	13	45	3
2022-45-3	●	2.2	13	45	3
2023-45-3	●	2.3	13	45	3
2024-45-3	●	2.4	15	45	3
2025-50-3	●	2.5	15	50	3
2026-50-3	●	2.6	15	50	3
2027-50-3	●	2.7	17	50	3
2028-50-3	●	2.8	17	50	3
2029-50-3	●	2.9	17	50	3
2030-62-6	●	3.0	20	62	6
2031-62-6	●	3.1	20	62	6
2032-62-6	●	3.2	20	62	6
2033-62-6	●	3.3	20	62	6
2034-62-6	●	3.4	20	62	6
2035-62-6	●	3.5	20	62	6

DESCRIPTION 형번	STOCK 재고	DIMENSIONS 치수			
		ØD	I	L	Ød
DSD 2036-62-6	●	3.6	20	62	6
2037-62-6	●	3.7	20	62	6
2038-66-6	●	3.8	24	66	6
2039-66-6	●	3.9	24	66	6
2040-66-6	●	4.0	24	66	6
2041-66-6	●	4.1	24	66	6
2042-66-6	●	4.2	24	66	6
2043-66-6	●	4.3	24	66	6
2044-66-6	●	4.4	24	66	6
2045-66-6	●	4.5	24	66	6
2046-66-6	●	4.6	24	66	6
2047-66-6	●	4.7	24	66	6
2048-66-6	●	4.8	28	66	6
2049-66-6	●	4.9	28	66	6
2050-66-6	●	5.0	28	66	6
2051-66-6	●	5.1	28	66	6
2052-66-6	●	5.2	28	66	6
2053-66-6	●	5.3	28	66	6
2054-66-6	●	5.4	28	66	6
2055-66-6	●	5.5	28	66	6
2056-66-6	●	5.6	28	66	6
2057-66-6	●	5.7	28	66	6
2058-66-6	●	5.8	28	66	6
2059-66-6	●	5.9	28	66	6
2060-66-6	●	6.0	28	66	6
2061-79-8	●	6.1	34	79	8

DSD

3XD

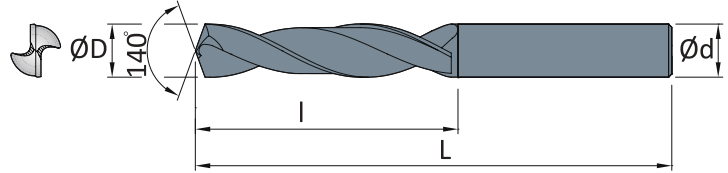

TURNING

GROOVING

THREADING

MILLING

DRILLING

ENDMILLS

DRILLS

SPARE PARTS

INDEX

DESCRIPTION 형번	STOCK 재고	DIMENSIONS 치수			
		øD	l	L	ød
DSD 2062-79-8	●	6.2	34	79	8
2063-79-8	●	6.3	34	79	8
2064-79-8	●	6.4	34	79	8
2065-79-8	●	6.5	34	79	8
2066-79-8	●	6.6	34	79	8
2067-79-8	●	6.7	34	79	8
2068-79-8	●	6.8	34	79	8
2069-79-8	●	6.9	34	79	8
2070-79-8	●	7.0	34	79	8
2071-79-8	●	7.1	41	79	8
2072-79-8	●	7.2	41	79	8
2073-79-8	●	7.3	41	79	8
2074-79-8	●	7.4	41	79	8
2075-79-8	●	7.5	41	79	8
2076-79-8	●	7.6	41	79	8
2077-79-8	●	7.7	41	79	8
2078-79-8	●	7.8	41	79	8
2079-79-8	●	7.9	41	79	8
2080-79-8	●	8.0	41	79	8
2081-89-10	●	8.1	47	89	10
2082-89-10	●	8.2	47	89	10
2083-89-10	●	8.3	47	89	10
2084-89-10	●	8.4	47	89	10
2085-89-10	●	8.5	47	89	10
2086-89-10	●	8.6	47	89	10
2087-89-10	●	8.7	47	89	10

DESCRIPTION 형번	STOCK 재고	DIMENSIONS 치수			
		øD	l	L	ød
DSD 2088-89-10	●	8.8	47	89	10
2089-89-10	●	8.9	47	89	10
2090-89-10	●	9.0	47	89	10
2091-89-10	●	9.1	47	89	10
2092-89-10	●	9.2	47	89	10
2093-89-10	●	9.3	47	89	10
2094-89-10	●	9.4	47	89	10
2095-89-10	●	9.5	47	89	10
2096-89-10	●	9.6	47	89	10
2097-89-10	●	9.7	47	89	10
2098-89-10	●	9.8	47	89	10
2099-89-10	●	9.9	47	89	10
2100-89-10	●	10.0	47	89	10
2101-102-12	●	10.1	55	102	12
2102-102-12	●	10.2	55	102	12
2103-102-12	●	10.3	55	102	12
2104-102-12	●	10.4	55	102	12
2105-102-12	●	10.5	55	102	12
2106-102-12	●	10.6	55	102	12
2107-102-12	●	10.7	55	102	12
2108-102-12	●	10.8	55	102	12
2109-102-12	●	10.9	55	102	12
2110-102-12	●	11.0	55	102	12
2111-102-12	●	11.1	55	102	12
2112-102-12	●	11.2	55	102	12
2113-102-12	●	11.3	55	102	12

타입

그루비

나사

밀링

인테셔널 드릴

엔드밀

솔리드 드릴

부품

색인표

DSD

3XD

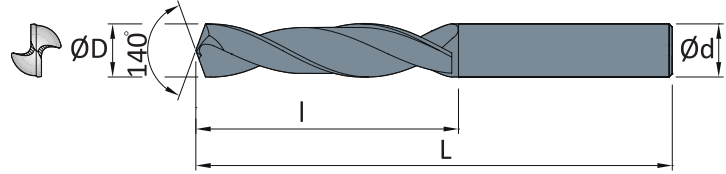

DESCRIPTION 형번	STOCK 재고	DIMENSIONS 치수			
		ØD	I	L	Ød
DSD 2114-102-12	●	11.4	55	102	12
2115-102-12	●	11.5	55	102	12
2116-102-12	●	11.6	55	102	12
2117-102-12	●	11.7	55	102	12
2118-102-12	●	11.8	55	102	12
2119-102-12	●	11.9	55	102	12
2120-102-12	●	12.0	55	102	12
2121-107-14	●	12.1	60	107	14
2122-107-14	●	12.2	60	107	14
2123-107-14	●	12.3	60	107	14
2124-107-14	●	12.4	60	107	14
2125-107-14	●	12.5	60	107	14
2126-107-14	●	12.6	60	107	14
2127-107-14	●	12.7	60	107	14
2128-107-14	●	12.8	60	107	14
2129-107-14	●	12.9	60	107	14
2130-107-14	●	13.0	60	107	14
2131-107-14	●	13.1	60	107	14
2132-107-14	●	13.2	60	107	14
2133-107-14	●	13.3	60	107	14
2134-107-14	●	13.4	60	107	14
2135-107-14	●	13.5	60	107	14
2140-107-14	●	14.0	60	107	14
2145-115-16	●	14.5	65	115	16
2150-115-16	●	15.0	65	115	16
2155-115-16	●	15.5	65	115	16

DESCRIPTION 형번	STOCK 재고	DIMENSIONS 치수			
		ØD	I	L	Ød
DSD 2160-115-16	●	16.0	65	115	16
2165-123-18	●	16.5	73	123	18
2170-123-18	●	17.0	73	123	18
2175-123-18	●	17.5	73	123	18
2180-123-18	●	18.0	73	123	18
2185-131-20	●	18.5	79	131	20
2190-131-20	●	19.0	79	131	20
2195-131-20	●	19.5	79	131	20
2200-131-20	●	20.0	79	131	20
2210-151-25	●	21.0	93	151	25
2220-151-25	●	22.0	93	151	25
2230-153-25	●	23.0	96	153	25
2240-153-25	●	24.0	96	153	25
2250-153-25	●	25.0	96	153	25

DLD

5XD

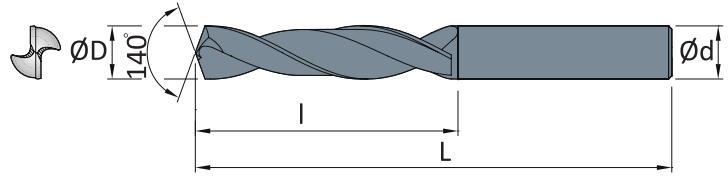

DESCRIPTION 형번	STOCK 재고	DIMENSIONS 치수				
		ØD	l	L	Ød	
DLD	2010-38-3	●	1.0	9	38	3
	2011-38-3	●	1.1	9	38	3
	2012-38-3	●	1.2	11	38	3
	2013-38-3	●	1.3	11	38	3
	2014-38-3	●	1.4	12	38	3
	2015-45-3	●	1.5	12	45	3
	2016-45-3	●	1.6	14	45	3
	2017-45-3	●	1.7	14	45	3
	2018-45-3	●	1.8	16	45	3
	2019-45-3	●	1.9	16	45	3
	2020-50-3	●	2.0	18	50	3
	2021-50-3	●	2.1	18	50	3
	2022-52-3	●	2.2	20	52	3
	2023-52-3	●	2.3	20	52	3
	2024-52-3	●	2.4	22	52	3
	2025-56-3	●	2.5	22	56	3
	2026-56-3	●	2.6	22	56	3
	2027-56-3	●	2.7	23	56	3
	2028-56-3	●	2.8	23	56	3
	2029-56-3	●	2.9	23	56	3
	2030-66-6	●	3.0	28	66	6
	2031-66-6	●	3.1	28	66	6
	2032-66-6	●	3.2	28	66	6
	2033-66-6	●	3.3	28	66	6
	2034-66-6	●	3.4	28	66	6
	2035-66-6	●	3.5	28	66	6

DESCRIPTION 형번	STOCK 재고	DIMENSIONS 치수				
		ØD	l	L	Ød	
DLD	2036-74-6	●	3.6	36	74	6
	2037-74-6	●	3.7	36	74	6
	2038-74-6	●	3.8	36	74	6
	2039-74-6	●	3.9	36	74	6
	2040-74-6	●	4.0	36	74	6
	2041-74-6	●	4.1	36	74	6
	2042-74-6	●	4.2	36	74	6
	2043-74-6	●	4.3	36	74	6
	2044-74-6	●	4.4	36	74	6
	2045-74-6	●	4.5	36	74	6
	2046-74-6	●	4.6	36	74	6
	2047-74-6	●	4.7	36	74	6
	2048-82-6	●	4.8	44	82	6
	2049-82-6	●	4.9	44	82	6
	2050-82-6	●	5.0	44	82	6
	2051-82-6	●	5.1	44	82	6
	2052-82-6	●	5.2	44	82	6
	2053-82-6	●	5.3	44	82	6
	2054-82-6	●	5.4	44	82	6
	2055-82-6	●	5.5	44	82	6
	2056-82-6	●	5.6	44	82	6
	2057-82-6	●	5.7	44	82	6
	2058-82-6	●	5.8	44	82	6
	2059-82-6	●	5.9	44	82	6
	2060-82-6	●	6.0	44	82	6
	2061-91-8	●	6.1	53	91	8

TURNING

GROOVING

THREADING

MILLING

DRILLING

ENDMILLS

DRILLS

SPARE PARTS

INDEX

터닝

그루빙

나사

밀링

인테셔널 드릴

엔드밀

솔리드 드릴

부품

색인표

DLD

5XD

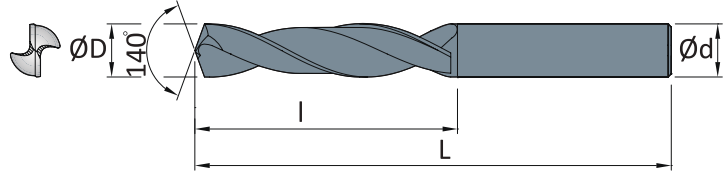

DESCRIPTION 형번	STOCK 재고	DIMENSIONS 치수			
		ØD	I	L	Ød
DLD 2062-91-8	●	6.2	53	91	8
2063-91-8	●	6.3	53	91	8
2064-91-8	●	6.4	53	91	8
2065-91-8	●	6.5	53	91	8
2066-91-8	●	6.6	53	91	8
2067-91-8	●	6.7	53	91	8
2068-91-8	●	6.8	53	91	8
2069-91-8	●	6.9	53	91	8
2070-91-8	●	7.0	53	91	8
2071-91-8	●	7.1	53	91	8
2072-91-8	●	7.2	53	91	8
2073-91-8	●	7.3	53	91	8
2074-91-8	●	7.4	53	91	8
2075-91-8	●	7.5	53	91	8
2076-91-8	●	7.6	53	91	8
2077-91-8	●	7.7	53	91	8
2078-91-8	●	7.8	53	91	8
2079-91-8	●	7.9	53	91	8
2080-91-8	●	8.0	53	91	8
2081-103-10	●	8.1	61	103	10
2082-103-10	●	8.2	61	103	10
2083-103-10	●	8.3	61	103	10
2084-103-10	●	8.4	61	103	10
2085-103-10	●	8.5	61	103	10
2086-103-10	●	8.6	61	103	10
2087-103-10	●	8.7	61	103	10

DESCRIPTION 형번	STOCK 재고	DIMENSIONS 치수			
		ØD	I	L	Ød
DLD 2088-103-10	●	8.8	61	103	10
2089-103-10	●	8.9	61	103	10
2090-103-10	●	9.0	61	103	10
2091-103-10	●	9.1	61	103	10
2092-103-10	●	9.2	61	103	10
2093-103-10	●	9.3	61	103	10
2094-103-10	●	9.4	61	103	10
2095-103-10	●	9.5	61	103	10
2096-103-10	●	9.6	61	103	10
2097-103-10	●	9.7	61	103	10
2098-103-10	●	9.8	61	103	10
2099-103-10	●	9.9	61	103	10
2100-103-10	●	10.0	61	103	10
2101-118-12	●	10.1	71	118	12
2102-118-12	●	10.2	71	118	12
2103-118-12	●	10.3	71	118	12
2104-118-12	●	10.4	71	118	12
2105-118-12	●	10.5	71	118	12
2106-118-12	●	10.6	71	118	12
2107-118-12	●	10.7	71	118	12
2108-118-12	●	10.8	71	118	12
2109-118-12	●	10.9	71	118	12
2110-118-12	●	11.0	71	118	12
2111-118-12	●	11.1	71	118	12
2112-118-12	●	11.2	71	118	12
2113-118-12	●	11.3	71	118	12

DLD

5XD

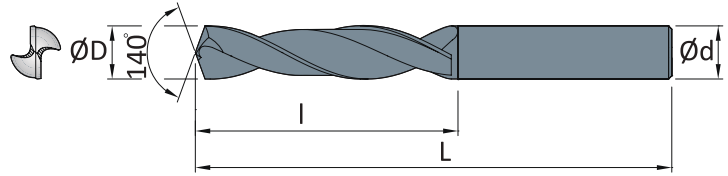

DESCRIPTION 형번	STOCK 재고	DIMENSIONS 치수			
		∅D	l	L	∅d
DLD 2114-118-12	●	11.4	71	118	12
2115-118-12	●	11.5	71	118	12
2116-118-12	●	11.6	71	118	12
2117-118-12	●	11.7	71	118	12
2118-118-12	●	11.8	71	118	12
2119-118-12	●	11.9	71	118	12
2120-118-12	●	12.0	71	118	12
2121-124-14	●	12.1	77	124	14
2122-124-14	●	12.2	77	124	14
2123-124-14	●	12.3	77	124	14
2124-124-14	●	12.4	77	124	14
2125-124-14	●	12.5	77	124	14
2126-124-14	●	12.6	77	124	14
2127-124-14	●	12.7	77	124	14
2128-124-14	●	12.8	77	124	14
2129-124-14	●	12.9	77	124	14
2130-124-14	●	13.0	77	124	14
2131-124-14	●	13.1	77	124	14
2132-124-14	●	13.2	77	124	14
2133-124-14	●	13.3	77	124	14
2134-124-14	●	13.4	77	124	14
2135-124-14	●	13.5	77	124	14
2140-124-14	●	14.0	77	124	14
2145-133-16	●	14.5	83	133	16
2150-133-16	●	15.0	83	133	16
2155-133-16	●	15.5	83	133	16

DESCRIPTION 형번	STOCK 재고	DIMENSIONS 치수			
		∅D	l	L	∅d
DLD 2160-133-16	●	16.0	83	133	16
2165-143-18	●	16.5	93	143	18
2170-143-18	●	17.0	93	143	18
2175-143-18	●	17.5	93	143	18
2180-143-18	●	18.0	93	143	18
2185-153-20	●	18.5	101	153	20
2190-153-20	●	19.0	101	153	20
2195-153-20	●	19.5	101	153	20
2200-153-20	●	20.0	101	153	20
2210-200-25	●	21.0	140	200	25
2220-200-25	●	22.0	140	200	25
2230-200-25	●	23.0	140	200	25
2240-200-25	●	24.0	140	200	25
2250-200-25	●	25.0	140	200	25

TURNING
GROOVING
THREADING
MILLING
DRILLING
ENDMILLS
DRILLS
SPARE PARTS
INDEX

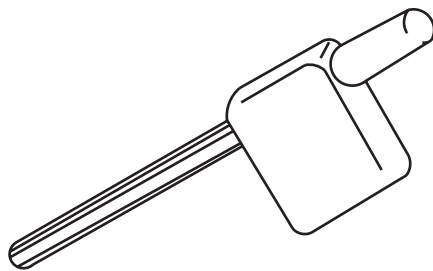
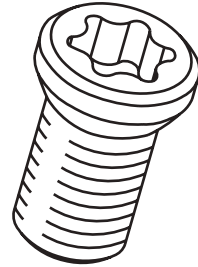
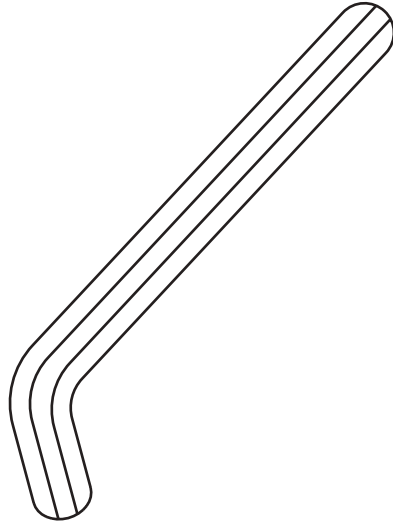

SPARE PARTS/ 부품

INSERTS CLAMPING SCREW / 인서트 스크류

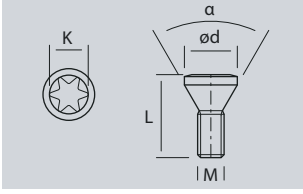

DESCRIPTION 형번	d	M	L	α	K	TORQUE (Nm)
ST-SC1804	2.60	M1.8 x 0.40	4.00	60°	T6	0.50
ST-SC0206	2.70	M2.0 x 0.40	6.00	60°	T6	0.50
ST-SC0226	3.10	M2.2 x 0.45	6.00	60°	T7	0.80
ST-SC0257	3.10	M2.5 x 0.45	7.00	60°	T7	0.80
ST-SC0309	4.30	M3.0 x 0.50	9.00	90°	T10	1.40
ST-SC3511	5.30	M3.5 x 0.60	11.0	60°	T15	3.50
ST-SC3514	5.30	M3.5 x 0.60	14.0	60°	T15	3.50
ST-SC3507	5.30	M3.5 x 0.60	7.00	60°	T15	3.50
ST-SC0411	5.50	M4.0 x 0.70	11.0	60°	T15	3.50
ST-SC0416	5.50	M4.0 x 0.70	16.0	60°	T15	3.50
ST-SC0415	5.50	M4.0 x 0.70	15.0	60°	T15	3.50
ST-SC4516	6.20	M4.5 x 0.75	16.0	60°	T15	3.50
ST-SC0513	7.00	M5.0 x 0.80	13.0	60°	T20	4.50
ST-SC0511	7.00	M5.0 x 0.80	11.0	60°	T20	4.50
ST-SC0512	7.00	M5.0 x 0.80	12.0	60°	T20	4.50
ST-SC0616	8.00	M6.0 x 1.00	16.0	60°	T20	4.50
ST-SC0523	7.00	M5.0 x 0.80	23.0	60°	T20	4.50
ST-SC0525	7.00	M5.0 x 0.80	25.0	60°	T20	4.50
ST-SC0630	8.00	M6.0 x 1.00	30.0	60°	T20	4.50
ST-SC6307	8.00	M6.0 x 1.00	30.0	90°	T20	4.50
ST-SC0830	9.50	M8.0 x 1.25	30.0	60°	T20	5.50
ST-SC6301	8.00	M6.0 x 1.00	30.0	90°	T20	4.50
ST-SC420	5.50	M4.0 x 0.70	20.0	60°	T15	3.50
ST-SC512	7.00	M5.0 x 0.80	12.0	60°	T20	4.50
ST-SC625	8.00	M6.0 x 1.00	25.0	60°	T20	4.50
ST-SC8301	9.50	M8.0 x 1.25	30.0	90°	T20	5.50
ST-SC610	8.00	M6.0 x 1.00	10.0	90°	T20	4.50
ST-SC810	9.50	M8.0 x 1.25	10.0	60°	T20	5.50

SHIM / 심

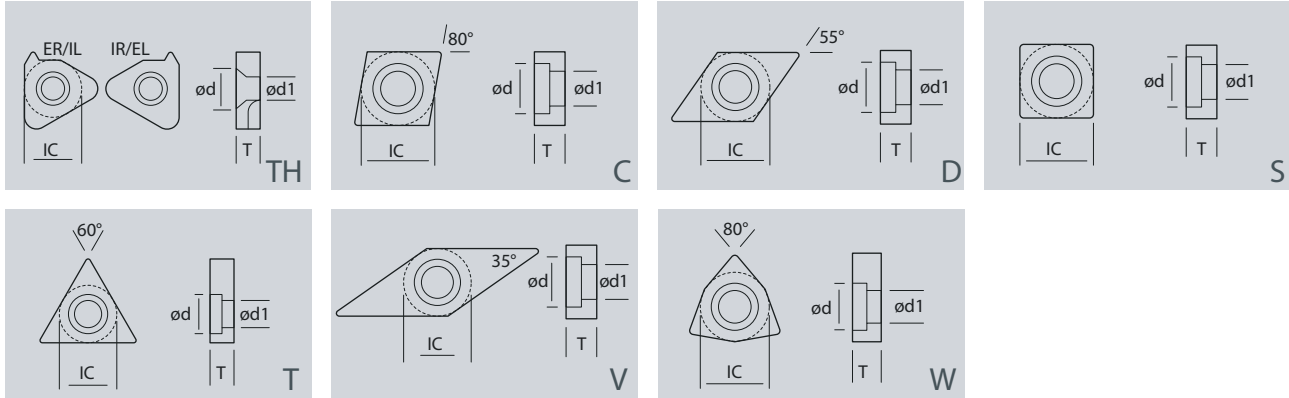

DESCRIPTION 형번	IC	T	Ød	Ød1	INSERT	DRAWING 그림
ST-SHDN11	8.50	3.20	6.60	5.20	DC 11, DN 11	ref. D
ST-SHDN15	12.50	3.20	8.40	6.70	DN 1506	ref. D
ST-SHCN12	12.50	3.20	8.40	6.70	CN 12	ref. C
ST-SHCN16	15.50	4.80	10.80	9.70	CN 16	ref. C
ST-SHCN19	18.70	4.80	13.10	11.20	CN 19	ref. C
ST-SHWN08	12.20	4.80	8.00	7.30	WN 08	ref. W
ST-SHSN12	12.30	4.80	8.00	7.30	SN 12	ref. S
ST-SHSN19	18.70	4.80	13.10	11.20	SN 19	ref. S
ST-SHTN16	9.30	3.20	6.60	5.80	TN 16	ref. T
ST-SHTN22	18.70	4.80	8.00	7.30	TN 22	ref. T
ST-SHVN16	9.20	3.20	6.60	5.80	VN 16	ref. V
ST-SHDC11	8.50	3.20	6.60	5.20	DC 11	ref. D
ST-SHSC09	12.20	4.80	8.00	7.30	SC 09	ref. S
ST-SHSC12	11.40	3.90	8.40	6.70	SC 12	ref. S
ST-SHCC09	8.50	3.20	6.60	5.20	CC 09	ref. C
ST-SHCC12	11.40	3.90	8.40	6.70	CC 12	ref. C
ST-SHVB16	8.20	3.20	6.60	5.40	VB 16	ref. V
ST-SHTC16	9.10	3.20	6.60	4.50	TC 16	ref. T
ST-SHVC16	8.20	3.20	6.60	5.40	VC 16	ref. V
ST-SHKNR/L	11.40	3.20	6.60	7.30	KN 16	ref. K
ST-SHEI16	9.50	3.20	6.00	4.20	16ER/16IR	ref. TH
ST-SHEI22	18.70	4.80	8.00	7.30	22ER/22IR	ref. TH

CLAMPS (M-STYLE CLAMPING) / 멀티락 홀더 클램프

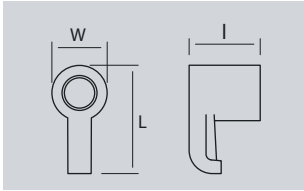

DESCRIPTION 형 번	W	L	I			
ST-CS006	9.40	18.20	13.50			
ST-CS007	7.90	16.90	7.90			
ST-CS008	7.75	14.90	10.95			
ST-CS009	9.40	18.20	13.50			

CLAMPS (D-STYLE CLAMPING) / 클램프 온 시스템 클램프

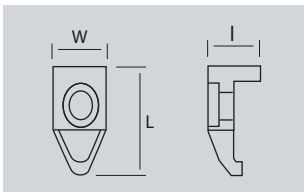

DESCRIPTION 형 번	∅d	M	L			
ST-CS001	9.70	M6x1	24.00			
ST-CS002	9.70	M6x1	24.00			
ST-CS003	9.70	M6x1	24.00			
ST-CS004	9.70	M6x1	24.00			
ST-CS004	9.70	M6x1	24.00			

CLAMPS (C-STYLE CLAMPING) / 클램프 온 시스템 클램프

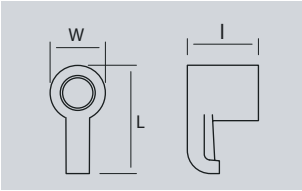

DESCRIPTION 형 번	W	L	I			
ST-CS010	9.40	18.20	13.50			
ST-CS011	7.90	16.90	7.90			
ST-CS012	9.40	18.20	13.50			
ST-CS013	7.90	16.90	7.90			

LEVER (P-STYLE CLAMPING) / 레버

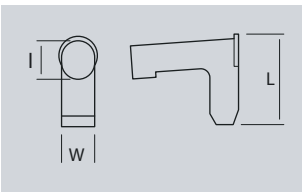

DESCRIPTION 형 번	W	L	I			
ST-LV001	4.75	13.60	4.45			
ST-LV002	4.60	14.50	5.00			
ST-LV003	4.70	14.80	5.10			

TURNING

GROOVING

THREADING

MILLING

DRILLING

ENDMILLS

DRILLS

SPARE PARTS

INDEX

LEVER LOCKING SYSTEM (P-STYLE CLAMPING) / 레버 스크류

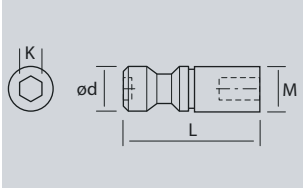

DESCRIPTION 형번	d	M	L	K		
ST-SC820	8.00	M8.0 x 1.00	20.0	HEXA 3		
ST-SC822	8.00	M8.0 x 1.00	22.0	HEXA 3		
ST-SC1020	10.00	M10.0 x 1.25	20.0	HEXA 4		
ST-SC1022	10.00	M10.0 x 1.25	22.0	HEXA 4		

ECCENTRIC LOCK PIN (M-STYLE CLAMPING) / 멀티락 심핀

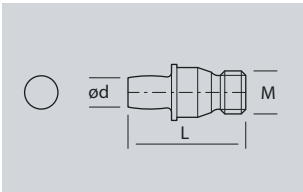

DESCRIPTION 형번	M	L	I			
ST-SP001	5.00	17.7	5.00			
ST-SP002	6.00	21.8	6.20			
ST-SP003	4.50	14.0	3.70			

DESCRIPTION			
08IR-A55	■ THREADING CARBIDE	226	
08IR-A60	■ THREADING CARBIDE	216	
11ER ISO	■ THREADING CARBIDE	218	
11ER NPT	■ THREADING CARBIDE	223	
11ER-A55	■ THREADING CARBIDE	217	
11ER-A60	■ THREADING CARBIDE	216	
11IR ISO	■ THREADING CARBIDE	219	
11IR NPT	■ THREADING CARBIDE	223	
11IR-A55	■ THREADING CARBIDE	217	
11IR-A60	■ THREADING CARBIDE	216	
16ER ISO	■ THREADING CARBIDE	218	
16ER BSPT	■ THREADING CARBIDE	221	
16ER NPT	■ THREADING CARBIDE	223	
16ER UN	■ THREADING CARBIDE	222	
16ER W	■ THREADING CARBIDE	220	
16ER-A55	■ THREADING CARBIDE	217	
16ER-A60	■ THREADING CARBIDE	216	
16ER-AG55	■ THREADING CARBIDE	217	
16ER-AG60	■ THREADING CARBIDE	216	
16ER-G55	■ THREADING CARBIDE	217	
16ER-G60	■ THREADING CARBIDE	216	
16ERM-AG55	■ THREADING CARBIDE	217	
16ERM-AG60	■ THREADING CARBIDE	216	
16IR ISO	■ THREADING CARBIDE	219	
16IR BSPT	■ THREADING CARBIDE	221	
16IR NPT	■ THREADING CARBIDE	223	
16IR W	■ THREADING CARBIDE	220	
16IR-A55	■ THREADING CARBIDE	217	
16IR-A60	■ THREADING CARBIDE	216	
16IR-AG55	■ THREADING CARBIDE	217	
16IR-AG60	■ THREADING CARBIDE	216	
16IR-G55	■ THREADING CARBIDE	217	
16IR-G60	■ THREADING CARBIDE	216	
16IRM-AG60	■ THREADING CARBIDE	217	
22ER ISO	■ THREADING CARBIDE	218	
22ER-N55	■ THREADING CARBIDE	217	
22ER-N60	■ THREADING CARBIDE	216	
22IR ISO	■ THREADING CARBIDE	219	
22IR-N55	■ THREADING CARBIDE	217	
22IR-N60	■ THREADING CARBIDE	216	
27ER-Q55	■ THREADING CARBIDE	217	
APKT AU	■ MILLING CARBIDE	236	
APKT GM	■ MILLING CARBIDE	236	
APKT PDER-G2	■ MILLING CARBIDE	236	
APKT PDFR-G2	■ MILLING CARBIDE	236	
APKT PDR	■ MILLING CARBIDE	236	
APKT PDSR	■ MILLING CARBIDE	236	
APKT TEM	■ MILLING CARBIDE	236	
APKT ZM	■ MILLING CARBIDE	236	
APMT PDER-H2-M2	■ MILLING CARBIDE	237	

DESCRIPTION			
B-D - - H45	■ ENDMILLS CARBIDE	306	
B-D - - H55	■ ENDMILLS CARBIDE	308	
B-D - - H68	■ ENDMILLS CARBIDE	310	
C SCLCR/L 03	■ TURNING HOLDERS	124	
C SCLCR/L 04	■ TURNING HOLDERS	124	
C SCLCR/L 06	■ TURNING HOLDERS	124	
C SCLCR/L 09	■ TURNING HOLDERS	124	
C SDQCR/L 07	■ TURNING HOLDERS	141	
C SDQCR/L 11	■ TURNING HOLDERS	141	
C STFCR/L 11	■ TURNING HOLDERS	169	
C STFPR/L 08	■ TURNING HOLDERS	169	
C STFPR/L 11	■ TURNING HOLDERS	169	
CCGT 1C	■ TURNING DIAMOND	99	
CCGT 2C	■ TURNING DIAMOND	99	
CCGT AU	■ TURNING carbide	22	
CCGW 1C	■ TURNING PCBN	79	
CCGW 1C	■ TURNING DIAMOND	99	
CCGW 2C	■ TURNING PCBN	79	
CCGW 2C	■ TURNING DIAMOND	99	
CCGX FE	■ TURNING DIAMOND	99	
CCMT GM	■ TURNING carbide	22	
CCMT MF	■ TURNING carbide	22	
CCMT MF1	■ TURNING carbide	22	
CCMT MF2	■ TURNING carbide	22	
CCMT MM1	■ TURNING carbide	23	
CCMT MM3	■ TURNING carbide	23	
CCMT MM5	■ TURNING carbide	23	
CCMT TQ	■ TURNING carbide	23	
CCMT UF	■ TURNING carbide	23	
CCMT UM	■ TURNING carbide	24	
CCMT UM2	■ TURNING carbide	24	
CCMT UR	■ TURNING carbide	24	
CCMT UR2	■ TURNING carbide	24	
CDJNR/L 15	■ TURNING HOLDERS	142	
CKJNR/L 16	■ TURNING HOLDERS	149	
CNGA 1C	■ TURNING PCBN	80	
CNGA 1C	■ TURNING DIAMOND	100	
CNGA 2C	■ TURNING PCBN	80	
CNGA 2C	■ TURNING DIAMOND	100	
CNGA 4C	■ TURNING PCBN	80	
CNMA	■ TURNING carbide	25	
CNMG	■ TURNING carbide	25	
CNMG AU	■ TURNING carbide	25	
CNMG MF	■ TURNING carbide	25	
CNMG MF2	■ TURNING carbide	25	
CNMG MF3	■ TURNING carbide	26	
CNMG MF4	■ TURNING carbide	26	
CNMG MM	■ TURNING carbide	26	
CNMG MM2	■ TURNING carbide	26	
CNMG MM3	■ TURNING carbide	26	

- TURNING
- GROOVING
- THREADING
- MILLING
- DRILLING
- ENDMILLS
- DRILLS
- SPARE PARTS
- INDEX

색인표

- 터너
- 그라인드
- 나사
- 임립
- 인테그럴 드릴
- 엔드밀
- 슬리드 드릴
- 부품
- 색인표

DESCRIPTION				
CNMG	MM4	■	TURNING carbide	27
CNMG	MR	■	TURNING carbide	27
CNMG	MS	■	TURNING carbide	27
CNMG	UF	■	TURNING carbide	28
CNMG	UF1	■	TURNING carbide	28
CNMG	UM	■	TURNING carbide	28
CNMG	UM1	■	TURNING carbide	28
CNMG	UMC	■	TURNING carbide	29
CNMG	UR	■	TURNING carbide	29
CNMG	UR1	■	TURNING carbide	29
CNMG	UR1	■	TURNING carbide	29
CNMM	RB25	■	TURNING carbide	27
CNMM	RH25	■	TURNING carbide	27
CRDCN	06	■	TURNING HOLDERS	150
CRDCN	09	■	TURNING HOLDERS	150
CRDCN	12	■	TURNING HOLDERS	150
CRDCN	15	■	TURNING HOLDERS	150
CRDCN	19	■	TURNING HOLDERS	150
CRDCN	25	■	TURNING HOLDERS	150
CSDNN	12	■	TURNING HOLDERS	156
CSSNN	12	■	TURNING HOLDERS	157
CTJNR/L	16	■	TURNING HOLDERS	170
DCGT	1C	■	TURNING DIAMOND	101
DCGT	2C	■	TURNING DIAMOND	101
DCGT	AU	■	TURNING carbide	30
DCGT	SF	■	TURNING carbide	30
DCGT	SF-OK	■	TURNING carbide	30
DCGT	SL	■	TURNING carbide	30
DCGW	1C	■	TURNING PCBN	81
DCGW	2C	■	TURNING PCBN	81
DCGX	FE	■	TURNING DIAMOND	101
DCMT	GM	■	TURNING carbide	30
DCMT	MF	■	TURNING carbide	30
DCMT	MF1	■	TURNING carbide	31
DCMT	MM1	■	TURNING carbide	31
DCMT	MM3	■	TURNING carbide	31
DCMT	MM5	■	TURNING carbide	31
DCMT	MR	■	TURNING carbide	31
DCMT	UF	■	TURNING carbide	31
DCMT	UM	■	TURNING carbide	32
DCMT	UM2	■	TURNING carbide	32
DCMT	UR	■	TURNING carbide	32
DCMT	UR2	■	TURNING carbide	32
DLD	- -	■	DRILLS CARBIDE	331
DLD	- -	■	DRILLS CARBIDE	332
DLD	- -	■	DRILLS CARBIDE	333
DNGA	1C	■	TURNING PCBN	82
DNGA	1C	■	TURNING DIAMOND	102
DNGA	2C	■	TURNING PCBN	82
DNGA	2C	■	TURNING DIAMOND	102

DESCRIPTION				
DNGA	4C	■	TURNING PCBN	82
DNMA		■	TURNING carbide	33
DNMG		■	TURNING carbide	33
DNMG	AU	■	TURNING carbide	33
DNMG	MF	■	TURNING carbide	33
DNMG	MF2	■	TURNING carbide	33
DNMG	MF3	■	TURNING carbide	34
DNMG	MF4	■	TURNING carbide	34
DNMG	MM	■	TURNING carbide	34
DNMG	MM2	■	TURNING carbide	34
DNMG	MR	■	TURNING carbide	34
DNMG	MS	■	TURNING carbide	35
DNMG	UF	■	TURNING carbide	35
DNMG	UF1	■	TURNING carbide	35
DNMG	UM	■	TURNING carbide	35
DNMG	UM1	■	TURNING carbide	35
DNMG	UMC	■	TURNING carbide	36
DNMG	UR	■	TURNING carbide	36
DNMG	UR1	■	TURNING carbide	36
DNMX	L/R	■	TURNING carbide	33
DSD	- -	■	DRILLS CARBIDE	328
DSD	- -	■	DRILLS CARBIDE	329
DSD	- -	■	DRILLS CARBIDE	330
KNUX	L/R	■	TURNING carbide	37
MAT	- - /	■	MILLING CUTTER	270
MFAP75	-10-	■	MILLING CUTTER	256
MFAP75	-10- -C	■	MILLING CUTTER	256
MFAP75	-16-	■	MILLING CUTTER	260
MFAP75	-16- -C	■	MILLING CUTTER	260
MFAP90	-10-	■	MILLING CUTTER	255
MFAP90	-10- -C	■	MILLING CUTTER	255
MFAP90	-12-	■	MILLING CUTTER	257
MFAP90	-16-	■	MILLING CUTTER	261
MFAP90	-16- -C	■	MILLING CUTTER	261
MFAP90	-17- -C	■	MILLING CUTTER	262
MFRD	-10-	■	MILLING CUTTER	266
MFRD	-10- -C	■	MILLING CUTTER	266
MFRD	-12-	■	MILLING CUTTER	266
MFRD	-12- -C	■	MILLING CUTTER	266
MFSE45	-	■	MILLING CUTTER	267
MFSE45	- -C	■	MILLING CUTTER	267
MFSN45	-	■	MILLING CUTTER	268
MFSN45	- -C	■	MILLING CUTTER	268
MFT	- - -	■	MILLING CUTTER	270
MFT	- - -	■	MILLING CUTTER	271
MFTP90	-16-	■	MILLING CUTTER	269
MFTP90	-22-	■	MILLING CUTTER	269
MGMN-C		■	GROOVING CARBIDE	196
MGMN-J		■	GROOVING CARBIDE	196
MGMR-J		■	GROOVING CARBIDE	196

DESCRIPTION			
MMAP - -10-	■ MILLING CUTTER	254	
MMAP - -10- -C	■ MILLING CUTTER	254	
MMAP - -16- -C	■ MILLING CUTTER	260	
MMRD - -08- -C	■ MILLING CUTTER	335	
MMRD - -10- -C	■ MILLING CUTTER	265	
MMRD - -12- -C	■ MILLING CUTTER	265	
MRMN-MTK	■ GROOVING CARBIDE	197	
MSAP - -10- -	■ MILLING CUTTER	252	
MSAP - -10- -	■ MILLING CUTTER	253	
MSAP - -10- - -C	■ MILLING CUTTER	252	
MSAP - -10- - -C	■ MILLING CUTTER	253	
MSAP - -12- -	■ MILLING CUTTER	257	
MSAP - -16- -	■ MILLING CUTTER	258	
MSAP - -16- -	■ MILLING CUTTER	258	
MSRD - -08- -	■ MILLING CUTTER	263	
MSRD - -10- -	■ MILLING CUTTER	263	
MSRD - -12- -	■ MILLING CUTTER	264	
MTENN 16	■ TURNING HOLDERS	170	
MTENN 22	■ TURNING HOLDERS	170	
MTER/L 11	■ THREADING HOLDERS	226	
MTER/L 16	■ THREADING HOLDERS	226	
MTER/L 22	■ THREADING HOLDERS	226	
MTIR/L 11	■ THREADING HOLDERS	227	
MTIR/L 16	■ THREADING HOLDERS	227	
MTIR/L 22	■ THREADING HOLDERS	227	
MTJNR/L 16	■ TURNING HOLDERS	171	
MTJNR/L 22	■ TURNING HOLDERS	171	
MWDNR/L 06	■ TURNING HOLDERS	186	
MWDNR/L 08	■ TURNING HOLDERS	186	
MWLNR/L 06	■ TURNING HOLDERS	186	
MWLNR/L 08	■ TURNING HOLDERS	186	
PCBNR/L 12	■ TURNING HOLDERS	125	
PCBNR/L 16	■ TURNING HOLDERS	125	
PCBNR/L 19	■ TURNING HOLDERS	125	
PCLNR/L 12	■ TURNING HOLDERS	126	
PCLNR/L 16	■ TURNING HOLDERS	126	
PCLNR/L 19	■ TURNING HOLDERS	126	
PCMNN 12	■ TURNING HOLDERS	127	
PCMNN 16	■ TURNING HOLDERS	127	
PCMNN 19	■ TURNING HOLDERS	127	
PDJNR/L 15	■ TURNING HOLDERS	142	
PDNNN 15	■ TURNING HOLDERS	142	
PSBNR/L 12	■ TURNING HOLDERS	157	
PSBNR/L 15	■ TURNING HOLDERS	157	
PSBNR/L 19	■ TURNING HOLDERS	157	
PSDNN 12	■ TURNING HOLDERS	158	
PSDNN 15	■ TURNING HOLDERS	158	
PSDNN 19	■ TURNING HOLDERS	158	
PSKNR/L 12	■ TURNING HOLDERS	159	
PSKNR/L 15	■ TURNING HOLDERS	159	

DESCRIPTION			
PSKNR/L 19	■ TURNING HOLDERS	159	
PSSNR/L 12	■ TURNING HOLDERS	160	
PSSNR/L 15	■ TURNING HOLDERS	160	
PSSNR/L 19	■ TURNING HOLDERS	160	
PWLNRL 06	■ TURNING HOLDERS	187	
PWLNRL 08	■ TURNING HOLDERS	187	
RCGT AUP	■ TURNING carbide	38	
RCGT AUP	■ MILLING CARBIDE	238	
RCGX FF	■ TURNING PCBN	83	
RCGX SO	■ TURNING PCBN	84	
RCKT MO	■ MILLING CARBIDE	238	
RCMT MO	■ MILLING CARBIDE	238	
RCMT MOTN	■ MILLING CARBIDE	238	
RCTX MO	■ TURNING carbide	38	
R-D - - H45	■ ENDMILLS CARBIDE	312	
R-D - - H55	■ ENDMILLS CARBIDE	315	
R-D - - H68	■ ENDMILLS CARBIDE	318	
RDGT AUP	■ MILLING CARBIDE	239	
RDHX MOT	■ MILLING CARBIDE	239	
RDKT MO	■ MILLING CARBIDE	239	
RDKT MOW	■ MILLING CARBIDE	239	
RDKW MO	■ MILLING CARBIDE	239	
RDKW MO	■ MILLING CARBIDE	239	
RDMT MOTN	■ MILLING CARBIDE	239	
RDMX MOT	■ MILLING CARBIDE	240	
RNGN SO	■ TURNING PCBN	85	
RPGT MO-AUP	■ MILLING CARBIDE	241	
RPKT MOF	■ MILLING CARBIDE	241	
RPKT MO-JS	■ MILLING CARBIDE	241	
RPMT MO	■ MILLING CARBIDE	241	
RPMT MOE	■ MILLING CARBIDE	241	
RPMW MO	■ MILLING CARBIDE	241	
RPMW MOT	■ MILLING CARBIDE	241	
RPMW MOTN	■ MILLING CARBIDE	241	
S SCLCR/L 06	■ TURNING HOLDERS	123	
S SCLCR/L 06	■ TURNING HOLDERS	123	
S STFCR/L 06	■ TURNING HOLDERS	166	
S SWLCR/L 16	■ TURNING HOLDERS	185	
S CKUNR/L 16	■ TURNING HOLDERS	149	
S MT-NR/L 16	■ TURNING HOLDERS	173	
S MT-NR/L 22	■ TURNING HOLDERS	173	
S MTQNR/L 16	■ TURNING HOLDERS	173	
S MTQNR/L 22	■ TURNING HOLDERS	173	
S MTUNR/L 16	■ TURNING HOLDERS	172	
S MTUNR/L 22	■ TURNING HOLDERS	172	
S MWLNR/L 06	■ TURNING HOLDERS	188	
S MWLNR/L 08	■ TURNING HOLDERS	188	
S PCLNR/L 12	■ TURNING HOLDERS	131	
S PCLNR/L 16	■ TURNING HOLDERS	131	
S PCLNR/L 19	■ TURNING HOLDERS	131	

- TURNING
- GROOVING
- THREADING
- MILLING
- DRILLING
- ENDMILLS
- DRILLS
- SPARE PARTS
- INDEX

색인표

- 터너
- 그라운드
- 나사
- 밀링
- 드릴
- 인덱서
- 엔드밀
- 속리드
- 복합
- 색인표

DESCRIPTION			
S	PDQNR/L 15	■ TURNING HOLDERS	146
S	PDUNR/L 15	■ TURNING HOLDERS	146
S	PSKNR/L 12	■ TURNING HOLDERS	162
S	PSKNR/L 15	■ TURNING HOLDERS	162
S	PWLNLR/L 08	■ TURNING HOLDERS	188
S	SCLCR/L 06	■ TURNING HOLDERS	123
S	SCLCR/L 09	■ TURNING HOLDERS	123
S	SCLCR/L 12	■ TURNING HOLDERS	123
S	SD-CR/L 07	■ TURNING HOLDERS	139
S	SD-CR/L 11	■ TURNING HOLDERS	139
S	SDPCR/L 07	■ TURNING HOLDERS	136
S	SDPCR/L 11	■ TURNING HOLDERS	136
S	SDQCR/L 07	■ TURNING HOLDERS	137
S	SDQCR/L 11	■ TURNING HOLDERS	137
S	SDUCR/L 07	■ TURNING HOLDERS	138
S	SDUCR/L 11	■ TURNING HOLDERS	138
S	SDXCR/L 07	■ TURNING HOLDERS	140
S	SDXCR/L 11	■ TURNING HOLDERS	140
S	SSSCR/L 09	■ TURNING HOLDERS	156
S	SSSCR/L 12	■ TURNING HOLDERS	156
S	ST-CR/L 09	■ TURNING HOLDERS	168
S	ST-CR/L 11	■ TURNING HOLDERS	168
S	ST-CR/L 16	■ TURNING HOLDERS	168
S	STFCR/L 09	■ TURNING HOLDERS	166
S	STFCR/L 11	■ TURNING HOLDERS	166
S	STFCR/L 16	■ TURNING HOLDERS	166
S	STUCR/L 09	■ TURNING HOLDERS	167
S	STUCR/L 11	■ TURNING HOLDERS	167
S	STUCR/L 16	■ TURNING HOLDERS	167
S	SVJBR/L 16	■ TURNING HOLDERS	179
S	SVQBR/L 11	■ TURNING HOLDERS	179
S	SVQBR/L 16	■ TURNING HOLDERS	179
S	SVQCR/L 11	■ TURNING HOLDERS	182
S	SVQCR/L 16	■ TURNING HOLDERS	182
S	SVUBR/L 11	■ TURNING HOLDERS	180
S	SVUBR/L 16	■ TURNING HOLDERS	180
S	SVUCR/L 11	■ TURNING HOLDERS	182
S	SVUCR/L 16	■ TURNING HOLDERS	182
S	SVXBR/L 11	■ TURNING HOLDERS	180
S	SVXBR/L 16	■ TURNING HOLDERS	180
S	TCLNR/L 12	■ TURNING HOLDERS	132
S	TCLNR/L 16	■ TURNING HOLDERS	132
S	TCLNR/L 19	■ TURNING HOLDERS	132
S	TD-NR/L 11	■ TURNING HOLDERS	148
S	TD-NR/L 15	■ TURNING HOLDERS	148
S	TDQNR/L 11	■ TURNING HOLDERS	147
S	TDQNR/L 15	■ TURNING HOLDERS	147
S	TDUNR/L 11	■ TURNING HOLDERS	147
S	TDUNR/L 15	■ TURNING HOLDERS	147
S	TSKNR/L 12	■ TURNING HOLDERS	162

DESCRIPTION			
S	TSKNR/L 15	■ TURNING HOLDERS	162
S	TT-NR/L 16	■ TURNING HOLDERS	174
S	TTUNR/L 16	■ TURNING HOLDERS	174
S	TTUNR/L 22	■ TURNING HOLDERS	174
S	TVUNR/L 16	■ TURNING HOLDERS	184
S	TWLNLR/L 06	■ TURNING HOLDERS	189
S	TWLNLR/L 08	■ TURNING HOLDERS	189
SAL-2Z	- - H45	■ ENDMILLS CARBIDE	321
SAL-3Z	- - H45	■ ENDMILLS CARBIDE	323
SCACR/L	06	■ TURNING HOLDERS	120
SCACR/L	09	■ TURNING HOLDERS	120
SCACR/L	12	■ TURNING HOLDERS	120
SCLCR/L	06	■ TURNING HOLDERS	121
SCLCR/L	09	■ TURNING HOLDERS	121
SCLCR/L	12	■ TURNING HOLDERS	121
SCMCN	06	■ TURNING HOLDERS	122
SCMCN	09	■ TURNING HOLDERS	122
SCMCN	12	■ TURNING HOLDERS	122
SCMT	UM	■ TURNING carbide	39
SCMT	UR	■ TURNING carbide	39
SCMT	UR2	■ TURNING carbide	39
S-D	- - H45	■ ENDMILLS CARBIDE	300
S-D	- - H55	■ ENDMILLS CARBIDE	302
S-D	- - H68	■ ENDMILLS CARBIDE	304
SDGN		■ GROOVING CARBIDE	198
SDGR		■ GROOVING CARBIDE	198
SDHCR/L	07	■ TURNING HOLDERS	133
SDHCR/L	11	■ TURNING HOLDERS	133
SDJCR/L	07	■ TURNING HOLDERS	134
SDJCR/L	11	■ TURNING HOLDERS	134
SDKN	FG-FG2	■ MILLING CARBIDE	242
SDMT	GM	■ MILLING CARBIDE	242
SDMT	SM	■ MILLING CARBIDE	242
SDNCN	07	■ TURNING HOLDERS	135
SDNCN	11	■ TURNING HOLDERS	135
SEET	FM	■ MILLING CARBIDE	243
SEET	SM	■ MILLING CARBIDE	243
SEKN	FG	■ MILLING CARBIDE	243
SEKN	FG2	■ MILLING CARBIDE	243
SNGA	1C	■ TURNING PCBN	86
SNGA	2C	■ TURNING PCBN	86
SNGA	4C	■ TURNING PCBN	86
SNGA	8C	■ TURNING PCBN	86
SNHQ		■ MILLING CARBIDE	244
SNHQ	MM	■ MILLING CARBIDE	244
SNHQ	S	■ MILLING CARBIDE	244
SNMA		■ TURNING carbide	40
SNMG		■ TURNING carbide	40
SNMG	AU	■ TURNING carbide	40
SNMG	HA	■ TURNING carbide	40

DESCRIPTION			
SNMG	MF	■ TURNING carbide	41
SNMG	MF3	■ TURNING carbide	41
SNMG	MM	■ TURNING carbide	41
SNMG	MM2	■ TURNING carbide	41
SNMG	MR	■ TURNING carbide	41
SNMG	MS	■ TURNING carbide	42
SNMG	UF	■ TURNING carbide	42
SNMG	UF1	■ TURNING carbide	43
SNMG	UM	■ TURNING carbide	43
SNMG	UM1	■ TURNING carbide	43
SNMG	UMC	■ TURNING carbide	43
SNMG	UR	■ TURNING carbide	44
SNMG	UR1	■ TURNING carbide	44
SNMM	RB25	■ TURNING carbide	42
SNMM	RH25	■ TURNING carbide	42
SNMX	ANN	■ MILLING CARBIDE	244
SPID	-05	■ DRILLING HOLDERS	280
SPID	-05	■ DRILLING HOLDERS	282
SPID	-05	■ DRILLING HOLDERS	284
SPID	-05	■ DRILLING HOLDERS	286
SPID	-06	■ DRILLING HOLDERS	280
SPID	-06	■ DRILLING HOLDERS	282
SPID	-06	■ DRILLING HOLDERS	284
SPID	-06	■ DRILLING HOLDERS	286
SPID	-07	■ DRILLING HOLDERS	280
SPID	-07	■ DRILLING HOLDERS	281
SPID	-07	■ DRILLING HOLDERS	282
SPID	-07	■ DRILLING HOLDERS	283
SPID	-07	■ DRILLING HOLDERS	284
SPID	-07	■ DRILLING HOLDERS	286
SPID	-09	■ DRILLING HOLDERS	281
SPID	-09	■ DRILLING HOLDERS	283
SPID	-09	■ DRILLING HOLDERS	285
SPID	-09	■ DRILLING HOLDERS	286
SPID	-11	■ DRILLING HOLDERS	281
SPID	-11	■ DRILLING HOLDERS	283
SPID	-11	■ DRILLING HOLDERS	285
SPID	-11	■ DRILLING HOLDERS	286
SPID	-14	■ DRILLING HOLDERS	281
SPID	-14	■ DRILLING HOLDERS	283
SPID	-14	■ DRILLING HOLDERS	285
SPKN	EDSL-FG	■ MILLING CARBIDE	245
SPKN	EDSL-FG2	■ MILLING CARBIDE	245
SPMG	-TT	■ DRILLING CARBIDE	277
SPMT	M	■ MILLING CARBIDE	245
SPPB	-	■ GROOVING HOLDERS	207
SP-TK		■ GROOVING CARBIDE	202
SPUN		■ MILLING CARBIDE	245
SRDCN	06	■ TURNING HOLDERS	151
SRDCN	08	■ TURNING HOLDERS	151

DESCRIPTION			
SRDCN	10	■ TURNING HOLDERS	151
SRDCN	12	■ TURNING HOLDERS	151
SRDCN	16	■ TURNING HOLDERS	151
SRDCN	20	■ TURNING HOLDERS	151
SRGCR/L	06	■ TURNING HOLDERS	152
SRGCR/L	08	■ TURNING HOLDERS	152
SRGCR/L	10	■ TURNING HOLDERS	152
SRGCR/L	12	■ TURNING HOLDERS	152
SRGCR/L	16	■ TURNING HOLDERS	152
SRGCR/L	20	■ TURNING HOLDERS	152
SRHCR/L	10	■ TURNING HOLDERS	153
SRHCR/L	12	■ TURNING HOLDERS	153
SRHCR/L	16	■ TURNING HOLDERS	153
SSDCN	09	■ TURNING HOLDERS	154
SSDCN	12	■ TURNING HOLDERS	154
SSSCR/L	09	■ TURNING HOLDERS	155
SSSCR/L	12	■ TURNING HOLDERS	155
STFCR/L	09	■ TURNING HOLDERS	163
STFCR/L	11	■ TURNING HOLDERS	163
STFCR/L	16	■ TURNING HOLDERS	163
STGCR/L	09	■ TURNING HOLDERS	164
STGCR/L	11	■ TURNING HOLDERS	164
STGCR/L	16	■ TURNING HOLDERS	164
STJCR/L	09	■ TURNING HOLDERS	165
STJCR/L	11	■ TURNING HOLDERS	165
STJCR/L	16	■ TURNING HOLDERS	165
SVHBR/L	11	■ TURNING HOLDERS	175
SVHBR/L	16	■ TURNING HOLDERS	175
SVHCR/L	11	■ TURNING HOLDERS	181
SVHCR/L	16	■ TURNING HOLDERS	181
SVJBR/L	11	■ TURNING HOLDERS	176
SVJBR/L	16	■ TURNING HOLDERS	176
SVJCR/L	11	■ TURNING HOLDERS	181
SVJCR/L	16	■ TURNING HOLDERS	181
SVVBN	11	■ TURNING HOLDERS	177
SVVBN	16	■ TURNING HOLDERS	177
SVZBR/L	11	■ TURNING HOLDERS	178
SVZBR/L	16	■ TURNING HOLDERS	178
TCGT	1C	■ TURNING DIAMOND	103
TCGT	3C	■ TURNING DIAMOND	103
TCGT	AU	■ TURNING carbide	45
TCGW	1C	■ TURNING PCBN	87
TCGW	1C	■ TURNING DIAMOND	103
TCGW	3C	■ TURNING PCBN	87
TCGW	3C	■ TURNING DIAMOND	103
TCGX	FE	■ TURNING DIAMOND	103
TCLNR/L	12	■ TURNING HOLDERS	128
TCLNR/L	16	■ TURNING HOLDERS	128
TCLNR/L	19	■ TURNING HOLDERS	128
TCMNN	12	■ TURNING HOLDERS	129

TURNING

GROOVING

THREADING

MILLING

DRILLING

ENDMILLS

DRILLS

SPARE PARTS

INDEX

색인표

DESCRIPTION			
TCMNN	16	■ TURNING HOLDERS	129
TCMNN	19	■ TURNING HOLDERS	129
TCMT	GM	■ TURNING carbide	45
TCMT	MF1	■ TURNING carbide	45
TCMT	MM1	■ TURNING carbide	45
TCMT	MM5	■ TURNING carbide	46
TCMT	UF	■ TURNING carbide	46
TCMT	UM	■ TURNING carbide	46
TCMT	UM2	■ TURNING carbide	47
TCMT	UR	■ TURNING carbide	47
TCMT	UR2	■ TURNING carbide	47
TCZNN	12	■ TURNING HOLDERS	130
TCZNN	16	■ TURNING HOLDERS	130
TCZNN	19	■ TURNING HOLDERS	130
TDHNR/L	15	■ TURNING HOLDERS	143
TDHNR/L	1504	■ TURNING HOLDERS	143
TDJNR/L	11	■ TURNING HOLDERS	144
TDJNR/L	15	■ TURNING HOLDERS	144
TDJNR/L	1504	■ TURNING HOLDERS	144
TDNNN	11	■ TURNING HOLDERS	145
TDNNN	15	■ TURNING HOLDERS	145
TDNNN	1504	■ TURNING HOLDERS	145
TG-C		■ GROOVING CARBIDE	199
TGDM		■ GROOVING CARBIDE	201
TGDR		■ GROOVING CARBIDE	201
TGER/L	-	■ GROOVING HOLDERS	206
TG-J		■ GROOVING CARBIDE	200
TG-J-R		■ GROOVING CARBIDE	200
GRIP		■ GROOVING CARBIDE	202
TG-T		■ GROOVING CARBIDE	200
TNGA	1C	■ TURNING PCBN	88
TNGA	1C	■ TURNING DIAMOND	104
TNGA	3C	■ TURNING PCBN	88
TNGA	3C	■ TURNING DIAMOND	104
TNGA	6C	■ TURNING DIAMOND	104
TNMA		■ TURNING carbide	48
TNMG		■ TURNING carbide	48
TNMG	AU	■ TURNING carbide	48
TNMG	GH	■ TURNING carbide	49
TNMG	L/R	■ TURNING carbide	48
TNMG	L/R-A3	■ TURNING carbide	48
TNMG	MF	■ TURNING carbide	49
TNMG	MF2	■ TURNING carbide	49
TNMG	MF3	■ TURNING carbide	49
TNMG	MF4	■ TURNING carbide	49
TNMG	MM	■ TURNING carbide	49
TNMG	MM2	■ TURNING carbide	50
TNMG	MR	■ TURNING carbide	50
TNMG	MS	■ TURNING carbide	50
TNMG	TQ	■ TURNING carbide	50

DESCRIPTION			
TNMG	UF	■ TURNING carbide	50
TNMG	UF1	■ TURNING carbide	50
TNMG	UM	■ TURNING carbide	51
TNMG	UM1	■ TURNING carbide	51
TNMG	UMC	■ TURNING carbide	51
TNMG	UR	■ TURNING carbide	52
TNMG	UR1	■ TURNING carbide	52
TPGT	1C	■ TURNING DIAMOND	105
TPGW	1C	■ TURNING PCBN	89
TPGW	3C	■ TURNING PCBN	89
TPKN	PDTR-FG	■ MILLING CARBIDE	246
TPMR		■ TURNING carbide	53
TPMR	D3	■ MILLING CARBIDE	246
TPMT	TQ	■ TURNING carbide	53
TPUN		■ MILLING CARBIDE	246
TPUN		■ TURNING carbide	53
TSDNN	12	■ TURNING HOLDERS	160
TSDNN	15	■ TURNING HOLDERS	160
TSKNR/L	12	■ TURNING HOLDERS	161
TSKNR/L	15	■ TURNING HOLDERS	161
TSSNR/L	12	■ TURNING HOLDERS	161
TSSNR/L	15	■ TURNING HOLDERS	161
TTENN	16	■ TURNING HOLDERS	171
TTENN	22	■ TURNING HOLDERS	171
TTJNR/L	16	■ TURNING HOLDERS	172
TTJNR/L	22	■ TURNING HOLDERS	172
TVHNR/L	16	■ TURNING HOLDERS	183
TVJNR/L	16	■ TURNING HOLDERS	183
TVNN	16	■ TURNING HOLDERS	184
TWLNRL	06	■ TURNING HOLDERS	187
TWLNRL	08	■ TURNING HOLDERS	187
VBGT	1C	■ TURNING DIAMOND	106
VBGT	2C	■ TURNING DIAMOND	106
VBGT	AU	■ TURNING carbide	54
VBGW	1C	■ TURNING PCBN	90
VBGW	1C	■ TURNING DIAMOND	106
VBGW	2C	■ TURNING PCBN	90
VBGW	2C	■ TURNING DIAMOND	106
VBMT		■ TURNING carbide	54
VBMT	GM	■ TURNING carbide	54
VBMT	MF	■ TURNING carbide	54
VBMT	MM	■ TURNING carbide	54
VBMT	MM1	■ TURNING carbide	54
VBMT	MM3	■ TURNING carbide	55
VBMT	MM4	■ TURNING carbide	55
VBMT	UF	■ TURNING carbide	55
VBMT	UM	■ TURNING carbide	55
VBMT	UR	■ TURNING carbide	55
VBMT	UR2	■ TURNING carbide	55
VCGT	1C	■ TURNING DIAMOND	107

터너

유니트

나사

임플

드릴
인테그레이티드

엔드밀

고속드릴

부속

색인표



세라타이거

 **HARTMANN**

Тел. +7 999 194 39 61

E-mail: info@hartman-n.ru
